



Design radiators for bathrooms

Prices and Technology 2023 - Sales International

always the best climate



ZEHNDER STUDIO COLLECTION



ALWAYS THE BEST CLIMATE

“We strive to improve the quality of life by providing the finest indoor climate solutions.”



Excellent team

Every day we combine passion, expert knowledge and commitment to give you the best results.



Great solutions, products and services

Great products and unique service for an energy-efficient, healthy and comfortable indoor climate.

WE ARE THE SPECIALISTS FOR A HEALTHY, COMFORTABLE AND ENERGY-EFFICIENT

The broad and clearly structured portfolio from the Zehnder Group is split into five product lines. Consequently, we can provide our customers with the right product, perfect system and matching service for all types of projects – from new build to renovations, single or multi-occupancy homes, as well as commercial projects. This variety ensures that our wealth of experience is continuously expanding, providing tangible added value to our customers on a daily basis.



Comfortable indoor ventilation

Our comfortable indoor ventilation is energy-efficient and provides a healthy indoor climate. It promotes the wellbeing of the occupants and increases the value of the property.

OUR BRAND REPRESENTS INNOVATION, QUALITY AND DESIGN

zehnder

The Zehnder brand offers excellent indoor climate solutions within the product lines of decorative radiators, comfortable indoor ventilation, heating and cooling ceiling and clean air solutions.

INNOVATION OVER 5 GENERATIONS



First choice for customers
Always close to the needs of our customers, to grow with you and overcome all challenges together.

MANUFACTURER OF THE WORLD'S

1st

STEEL AND BATHROOM RADIATORS

REPRESENTED IN MORE THAN

70 COUNTRIES

AROUND **3,500** EMPLOYEES

17 OF OUR OWN PRODUCTION PLANTS IN EUROPE, NORTH AMERICA AND CHINA

INNOVATION SINCE **1895**

AROUND **40,000** TRAINED CUSTOMERS PER YEAR

900 PATENTS AND DESIGN RIGHTS THROUGHOUT THE WORLD

INDOOR CLIMATE



Decorative radiators
Our individual decorative radiators make every room – whether at home or in commercial or public buildings – not only warmer, but also more attractive. They combine iconic design with outstanding comfort experience.



Heating and cooling ceiling
The ceiling is the perfect place to supply a room with convenient heating and cooling. Energy-efficient climate via radiant panels work perfectly with our suite of solutions from office to manufacturing spaces.



Clean air solutions
Air cleaning systems from Zehnder effectively reduce the amount of dust and other particles in the air. The result: clean working environments, significantly improved employee health and enhanced business performance.

BEST QUALITY CERTIFICATES

Zehnder Group products are frequently awarded prizes for design and innovative technology.

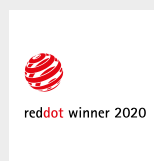
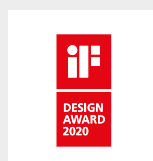









































ZEHNDER STUDIO COLLECTION















from page **6**



Premium Collection































	Zehnder Yucca	  	YS..	54
	Zehnder Yucca Asym	  	YA..	58
	Zehnder Vitalo Bar	 	VIP..	62
	Zehnder Fain	 	DV..	66
	Zehnder Roda Twist Spa Air		ROE..	70
	Zehnder Charleston Bar		CPV..	72
	Zehnder Metropolitan Spa	  	MET..	75
	Zehnder Metropolitan Bar	  	MEP..	78
	Zehnder Kazeane	  	RK..	82
	Zehnder Roda Spa Asym		ROF..	85
	Zehnder Quaro	  	QA..	88
	Zehnder Subway	  	SUB..	93





Quality Collection

	Zehnder Toga	  	TG/TE..	98
	Zehnder Forma Asym	  	LFA..	102
	Zehnder Forma Spa	  	LF..	106
	Zehnder Fina Lean Bar	 	FIF..	110

General Sales and Delivery Conditions:

Our General Sales and Delivery Conditions apply. You can find these under “Legal notice” on our homepage at www.international.zehnder-systems.com.

		Zehnder Klaro	  	ZSL..	113
		Zehnder Stalox	 	STX..	117
		Zehnder Bluebell		BLU..	119
		Zehnder Aura	  	PBN..	121
		Zehnder Aura Bow	  	PBTN..	126
Bathroom Essentials		Zehnder Virando	  	AB..	132
		Zehnder Virando Bow	 	ABT..	136
		Zehnder Impa	 	IMP..	140
		Zehnder Zeta	 	PQ6..	143
Accessories and general information	Retrofit solutions				150
	Room dividers				151
	Accessories				152
	Thermostats & Valves				164
	Coloured Thermostats and Valves				167
	Conversion factors				171
	Keyword list				172
	Zehnder World of Colours				182
How about an comfortable indoor ventilation?	Zehnder comfort ventilation				179

-  Operation on central heating system
-  Dual energy operation with integrated electric heating element; hot water models can be converted to dual energy operation on site*
-  Dual energy operation possible on site*
-  Electric operation*

* Additional information about the versions with electric operation and dual energy operation is available on the respective product pages.

Zehnder World of Colours

Unique color worlds for bathrooms and living rooms

From our choice of clothing to our living environment. Colours allow customers to create their ideal individual style & space. Zehnder has recognised and responded to these new expectations and demands. The new Zehnder colour system gives your customers every option to perfectly coordinate the colour of their radiators with the latest interior design trends, seamlessly integrating them into any environment. From our choice of clothing to our living environment. Colours allow customers to create their ideal individual style & space.

Zehnder has recognised and responded to these new expectations and demands. The new Zehnder colour system gives your customers every option to perfectly coordinate the colour of their radiators with the latest interior design trends, seamlessly integrating them into any environment. The future of colours and aligning with today and tomorrow's trends is important to Zehnder, that's why the expertise of renowned colour trend experts was drawn on during the concept development. Long-term trends in six areas: architecture, interior design, bathrooms, living spaces, surfaces and materials were analysed and integrated into the concept, culminating in a future-oriented colour palette. Five modern Zehnder colour worlds were derived from these colour and living trends to ensure that the system always remains up to date and that the balance between fashions and long-term trends is maintained.

The Sanctuary

The home as a place of rest, relaxation and retreat

The home is a place of relaxation and tranquillity. Rough surfaces, brushed finishes, mixed glazes and natural materials create sanctuaries. Natural off-white, light brown and grey tones are the key to a cosy environment to relax in. Brushed metals such as brass mixed with wood create a modern contrast. Round shapes and soft textures soften any feeling of austerity.



The Mystical Home

A private place for personal rituals and wellness

Rough, natural surfaces contrast with refined designs. Rough concrete textures mixed with polished stone surfaces create a multi-sensory experience. Black and dark grey shades, graphite and taupe are the key to a mystical home. The monochrome rooms are accentuated by dark blue tones and brushed metal. The muted colour palette is made for a tranquil space for personal rituals and wellness.



Neo Green

Reflections on our desire for a natural environment

Green tones create a balance with our desire for more nature in our lives. Walls and floors, but also textiles and décor appear in shades of green. Soft, delicate mint or petrol-coloured graphite reflect our desire for a natural environment. Nude, light brown and grey tones create harmony and calm.



Mother Earth

Terracotta as a symbol for a warm and earthy look

Terracotta helps create an earthy and warm look, both as a material and as a colour. The highly pigmented quality of terracotta and the deeply saturated yet sun-faded solid colours create a natural and sophisticated look. Shades of cotton white, ochre, brick red and brown are combined to create an earthy colour palette. Terracotta is symbolic of the earth we live on and our strong desire to protect it.



Mono Material Concrete

The continuity of space – rough, seamless, expressive

The use of a single material creates a seamless, uniform look and a quiet space – free of visual noise. Raw concrete flows from the interior to the exterior, giving continuity to the space.

Eccentric orange and natural brown tones create a modern contrast. Home accessories in brushed metal are perfectly combined.

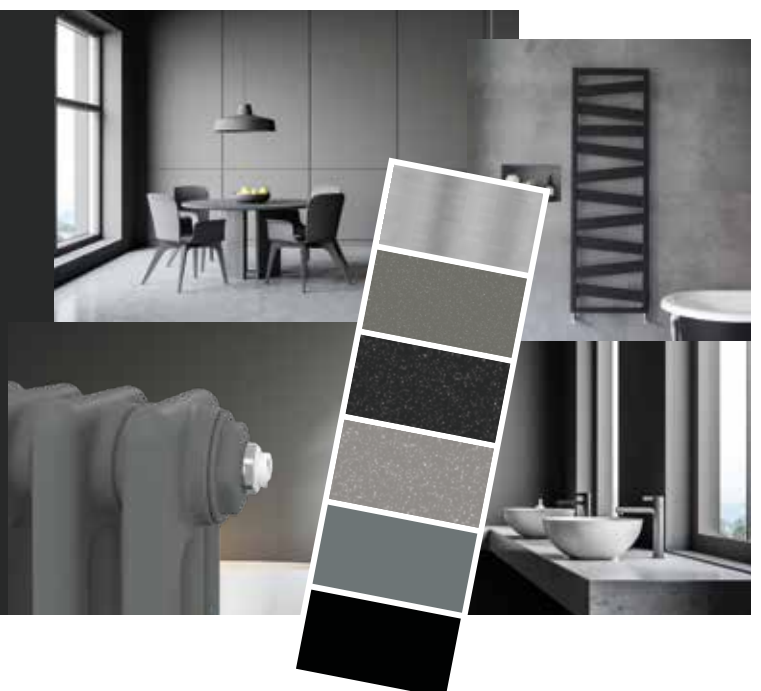

WHEN FORM FOLLOWS FUNCTION

The new **Zehnder Studio Collection** stands for the highest quality of Zehnder, paired with uniqueness, attention to detail and exclusivity. With the slogan „**when form follows function**“, Zehnder sums up the essence of the new product range: form follows function. The Zehnder portfolio is thus enriched with products for which **innovative designs and technologies** play a central role as well as harmoniously combined.

The Zehnder Studio Collection embodies products with unique, individual, exclusive and functional design, in which the **heritage of the RUNTAL brand lives on**. Get to know our new product world of the Zehnder Studio Collection!

ZEHNDER STUDIO COLLECTION

	Zehnder Alban		ALZ..	8
	Zehnder Archibald		ABZ..	12
	Zehnder Arteplano		VZ..	17
	Zehnder Chime		CHZ..	23
	Zehnder Deseo Verso		DV..	27
	Zehnder Folio Belt		FZB..	31
	Zehnder Folio Glass		FZ..	36
	Zehnder Folio Hybrid		FZH..	40
	Zehnder Zenia		ZEN..	45



Operation on central heating system



Hybrid: dual energy operation for hot water central heating system and electric operation



Electric operation*



Electric operation on request

* Additional information about the versions with electric operation and dual energy operation is available on the respective product pages.

STUDIO COLLECTION

ZEHNDER ALBAN

A design concept made for purists – precise lines, flat sides and right angles. The angular radiator with a practical side – slide on and hang up towels effortlessly with just one hand. Connected directly to the central heating system, this decorative radiator keeps the bathroom warm and comfortable. Zehnder Alban from the Studio Collection: the design version made of hand-polished, high-quality stainless steel. Simple, elegant design – and warm towels whenever you need them.





Radiator surface: Hand-polished stainless steel

STUDIO COLLECTION ZEHNDER ALBAN



Radiator surface: Hand-polished stainless steel

Operation on central heating system

The Zehnder Alban decorative radiator from the Studio Collection is a designer piece made of hand-polished, high-quality stainless steel with horizontally arranged square pipes and vertical header tubes. Bath towels can be effortlessly inserted at the side and hung up with just one hand. Square tubes 50 x 30 mm, header tubes 30 x 30 mm. Thermal outputs to EN 442, with CE marking.

4 x 1/2" female thread on the ends of the header tubes. Option to choose installation as right-hand or left-hand version (flow/return at the bottom with left or right options), distance 50 mm; 2 x 1/2" directional air vent at top, screwed in at the factory for installation as right-hand version. Delivered ready to install with elegant wall brackets in chrome.

Standard scope of delivery for operation on central heating system

- Hand-polished stainless steel
- 4 x 1/2" connections for flow, return, vent
- 2 x directional air vent 1/2" screwed in at the factory for installation as right-hand version
- Elegant wall brackets in chrome
- Packaging

Operating pressure	max. 5.2 bar
Operating temperature	max. 90 °C
Height mm
Length mm
Model

Advantages

- Hand-polished stainless steel surface for an exclusive look
- Ideal for hanging up towels thanks to large tube spacing
- Can be installed as a right-handed or left-handed version
- High-quality stainless steel surface ensures easy cleaning and maximum hygiene

STUDIO COLLECTION ZEHNDER ALBAN

Overview of models

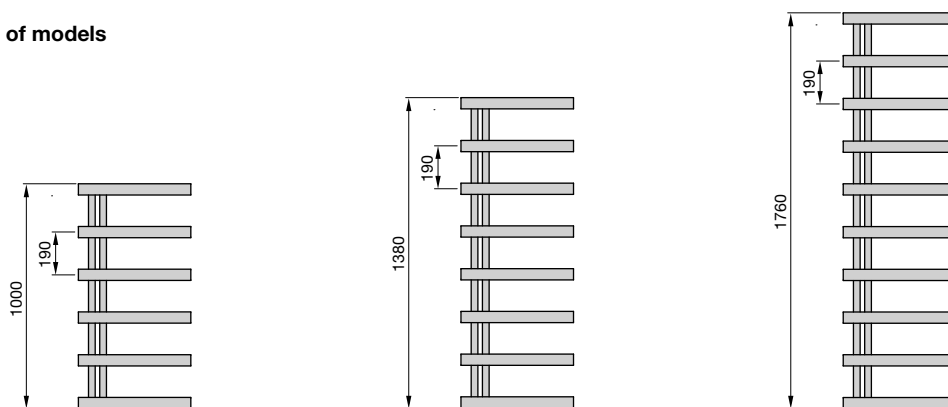

Connection to hot water central heating system

Stainless steel version

Model	H mm	L mm	Thermal output				Exp. n	Classification Electric heating element Watt	V dm ³	M kg	Price Stainless steel €
			EN 442 [ⓐ] W	70/55/24 W	55/45/24 W	55/45/20 W					
ALZ-100-050	1000	500	256	182	112	134	1.25	-	5.5	6.6	1.167,30
ALZ-140-050	1380	500	332	233	140	170	1.30	-	7.4	8.7	1.412,28
ALZ-180-050	1760	500	417	298	183	220	1.24	-	9.3	10.8	1.700,51

Special solution on request (surcharge)	Article no.	Price €
■ Zehnder thermostat	-	see page 164
■ Zehnder valves, return screw connections and fittings	-	see page 165 onwards

Operation on central heating system:

Wall mounting, installation as right-hand version

Wall mounting, installation as left-hand version

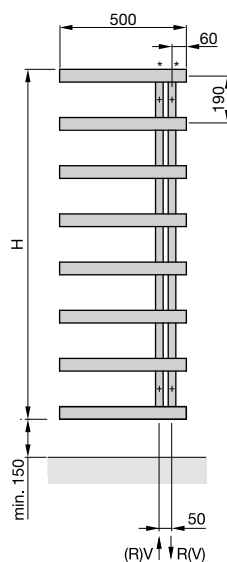
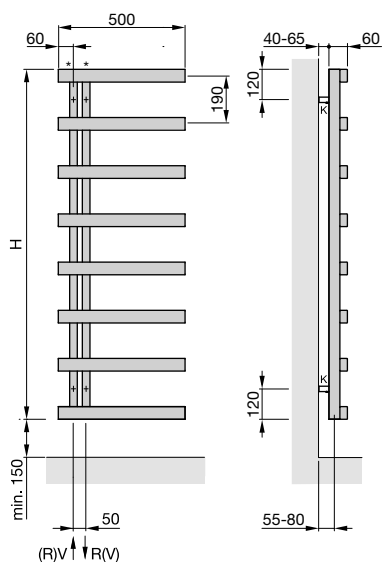

H = Height
V = Flow
R = Return
K = Bracket(s)
* = Vent

Dimensions in mm

ⓐ Thermal output to EN 442, ΔT 50 K (75/65/20 °C)

STUDIO COLLECTION

ZEHNDER ARCHIBALD

Always at your service. This unique decorative radiator is both elegant and highly functional. Zehnder Archibald from the Studio Collection is the perfect practical bathroom accessory, offering indulgently warm towels and creating a pleasant, comfortable indoor climate. Seamlessly formed from a single curved steel tube, the shape is as striking as the construction is unique. With Zehnder Archibald, designer Leo Salzedo has created a stylish and contemporary room feature that combines functionality with distinctive design.





Radiator surface: Chrome

STUDIO COLLECTION ZEHNDER ARCHIBALD



Radiator surface: Chrome

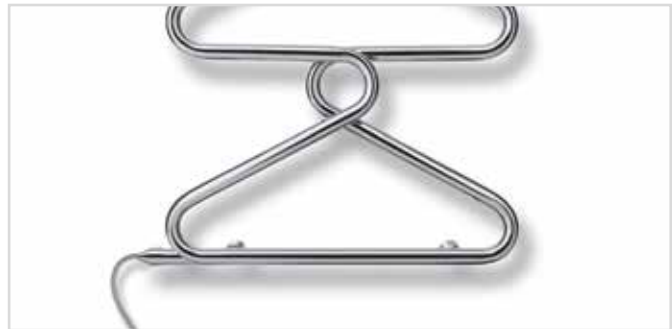
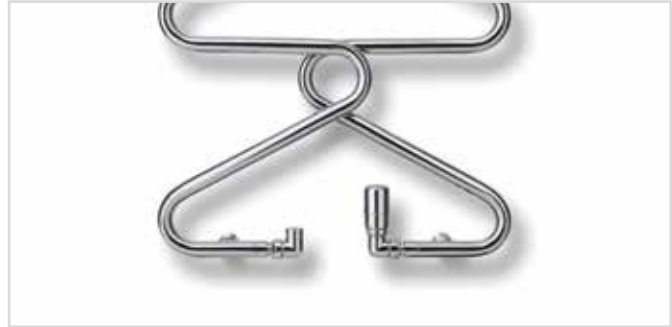

Operation on central heating system

Seamlessly formed from a single curved steel tube, the shape is as striking as the construction is unique. Zehnder Archibald from the Studio Collection creates a stylish and contemporary room feature that combines functionality with distinctive design. Its space-saving design can hold up to four towels, which can be heated simultaneously. Round tubes Ø 25 mm made of steel.

Thermal outputs to EN 442, with CE marking. Standard 2 x 1/2" with female thread, flow/return installed with left-hand or right-hand option, at the bottom horizontal facing inwards, 1/4" vent at the top facing the rear. Ideal with valve unit and return screw connection in an angle-angle design.

Radiator with powder coating, in the colour RAL 9016 as standard, in a special colour or in chrome on request. Delivered ready to install with matching wall brackets in colour of radiator.

Electric operation

Seamlessly formed from a single curved steel tube, the shape is as striking as the construction is unique. Zehnder Archibald creates a stylish and contemporary room feature that combines high functionality with distinctive design. Its space-saving design can hold up to four towels, which can be heated simultaneously.

Round tubes Ø 25 mm made of steel. With integrated electric heating element, degree of protection IP44 (splash-proof), for mains power supply of 230 V. With connection cable 1.2 m in length with two pin plug. White cable, plug and cable cover; chrome radiators have a grey cable and plug with a chrome cable cover. Decorative radiator filled with heat transfer fluid. The electric heating element does not have any operating options. The control has to be planned and executed on site.

Radiator with powder coating, in colour RAL 9016 as standard, in special colour or chrome on request. Delivered ready to install with matching wall brackets in colour of radiator.

Operating pressure	max. 12.0 bar	Output W
Operating temperature	max. 110 °C	Height mm
Height mm	Length mm
Length mm	Model
Model		

Advantages

- Innovative design
- Seamlessly finished with curved steel
- Ideal for hanging up towels
- Space-saving design

Special benefits for electric operation

- On-site control
- Fixed medium temperature of approx. 70 °C
- Ready-to-plug
- Cable, plug and cable cover in white or grey/chrome depending on version

STUDIO COLLECTION ZEHNDER ARCHIBALD

Overview of models

Operation on central heating system Electric operation

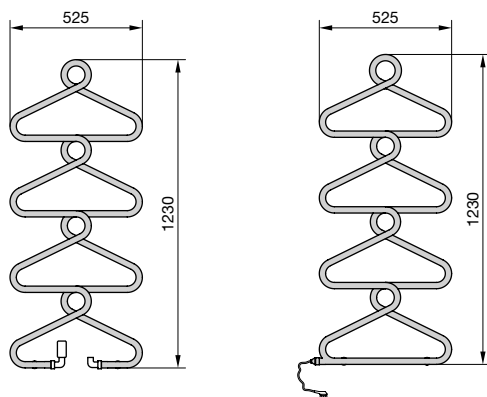

Connection to hot water central heating system

Painted version

Model	H mm	L mm	Thermal output				Exp. n	Classification Electric heating element Watt	V dm ³	M kg	Price RAL 9016 €	Price ^① Cat. 1 €
			EN 442 ^② W	70/55/24 W	55/45/24 W	55/45/20 W						
ABZ-120-50	1230	525	336	241	150	179	1.22	-	2.3	4.6	1.245,35	1.556,68

Chrome-plated version

Model	H mm	L mm	Thermal output				Exp. n	Classification Electric heating element Watt	V dm ³	M kg	Price Chrome €
			EN 442 ^② W	70/55/24 W	55/45/24 W	55/45/20 W					
ABZC-120-50	1230	525	233	166	102	122	1.25	-	2.3	4.6	1.731,75

Electric-only operation

Painted version



Model	H mm	L mm	Classification Electric heating element Watt	Price RAL 9016 €	Price ^① Cat. 1 €
ABZ-120-50/AD	1230	525	200	1.636,40	1.881,86

Chrome-plated version

Model	H mm	L mm	Classification Electric heating element Watt	Price Chrome €
ABZC-120-50/AD	1230	525	200	2.170,36

Standard scope of delivery for operation on central heating system

- Powder coating to DIN 55900, RAL 9016
- 2 x ½" connections for flow, return
- 1 x ¼" vent
- Elegant wall brackets in radiator colour
- Packaging

Standard scope of delivery for electric operation

- Powder coating to DIN 55900, RAL 9016
- Filled with heat transfer fluid, frost-proof to -10 °C
- Built-in electric heating element, integrated into the design
- Elegant wall brackets in radiator colour
- Packaging

① For special colours in categories 1 and 2, see special solutions and colour chart

② Thermal output to EN 442, ΔT 50 K (75/65/20 °C)

For keywords, see 'Electric operation and Ecodesign Directive' on page 173

STUDIO COLLECTION ZEHNDER ARCHIBALD

Special solution on request (surcharge)	Article no.	Price €
■ Special finish to category 2 (surcharge on cat. 1)	-	146,76
■ Zehnder thermostat	-	see page 164
■ Zehnder valves, return screw connections in an angle-angle design	-	see page 165 onwards

Operation on central heating system:

Wall mounting

Back cover

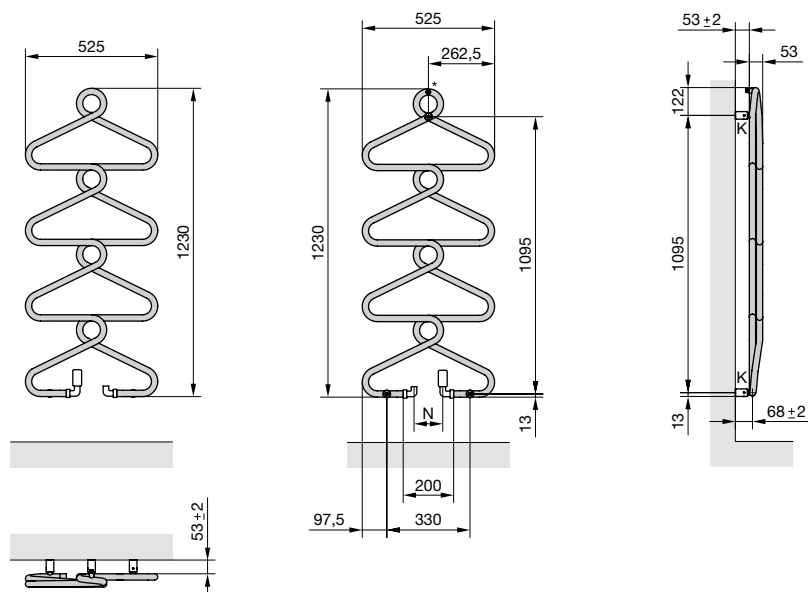

Electric operation:

Wall mounting

Back cover

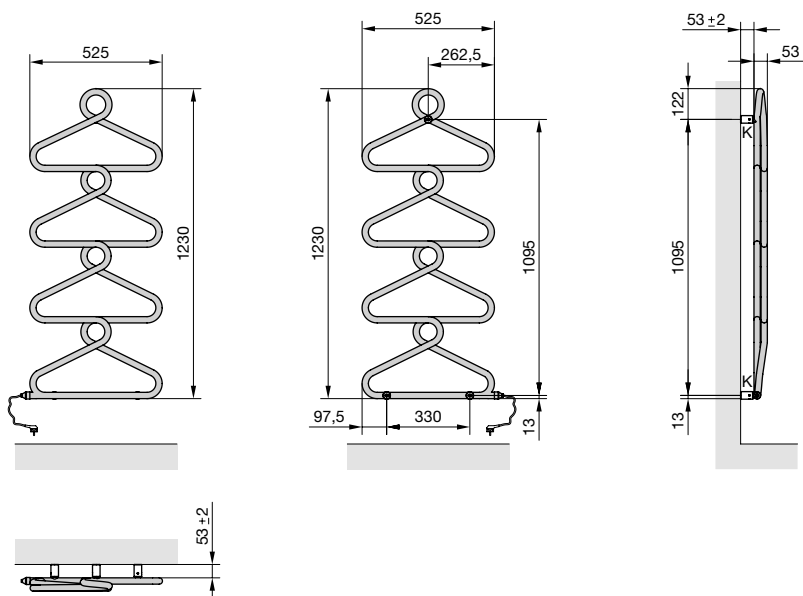

- K = Bracket(s)
- N = Connection size depends on the valve or return screw connection
- * = Vent

Dimensions in mm

STUDIO COLLECTION

ZEHNDER ARTEPLANO

Pure and simple. This decorative radiator celebrates the perfection of material and finish, combining state-of-the-art heating technology with striking contemporary design. The smooth surfaces efficiently give out a pleasing warmth whilst subtly integrating the radiator into the room. Alternatively, it can be transformed into a feature in its own right with the wide selection of materials and finishes. The only limit is your imagination. Zehnder Arteplano from the Studio Collection. The art of making a statement.





Radiator surface: Stained brass

STUDIO COLLECTION ZEHNDER ARTEPLANO



Radiator surface: Stained copper



Radiator surface: Stainless steel, mirror polished

Operation on central heating system

Zehnder Arteplano from the Studio Collection is impressive with its smooth surface, creating a cosy warmth in no time with its exceptional responsiveness. With such a wide range of materials and finishes to choose from, the decorative radiator integrates harmoniously into any room.

Flat front, thermo-lacquered steel as standard. With optional towel rail for retrofitting at any height. Several towel rails possible for each radiator. Side covers permanently welded to the radiator and not removable (model VZA and VZLA included in standard scope of delivery). Thermal output to EN 442, with CE marking. With the factory standard connections with 4 x 1/2" female thread, the following connection types are possible. 1/2" flow/return at bottom vertical opposite end, installed with left, right or centre option 50 mm, with 1/2" directional air vent at top right.

Radiator with powder coating, in colour RAL 9016 as standard, in special colour or surface. Delivered ready to install with wall brackets.

Operating pressure	max. 4.6 bar
Operating temperature	max. 80 °C
Height mm
Length mm
Model

Advantages

- Sleek design
- Several exclusive surfaces to choose from
- Variety of models suitable for a wide range of local conditions
- Quick responsiveness
- High-quality decorative panel radiator

STUDIO COLLECTION ZEHNDER ARTEPLANO

Overview of models

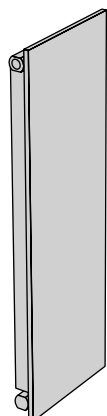

VZA

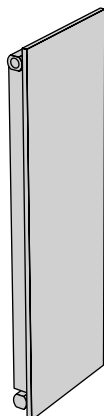

VZLA

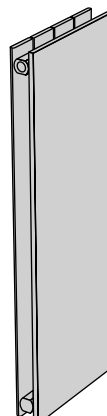

VZAD

Connection to hot water central heating system

Painted version

Model	H mm	L mm	Thermal output				Exp. n	Classification Electric heating element Watt	V dm ³	M kg	Price RAL 9016 €	Price [Ⓞ] Cat. 1 €
			EN 442 [Ⓞ] W	70/55/24 W	55/45/24 W	55/45/20 W						

Single-layer version

VZA160-4	1613	305	461	324	195	235	1.30	-	2.6	20.4	1.007,45	1.259,31
VZA180-4	1813	305	517	364	218	264	1.30	-	2.9	22.8	1.085,93	1.357,40
VZA200-4	2013	305	574	404	242	293	1.30	-	3.1	25.1	1.158,69	1.448,35
VZA160-6	1613	453	695	489	294	355	1.30	-	3.9	30.6	1.255,72	1.569,65
VZA180-6	1813	453	780	549	329	398	1.30	-	4.3	34.1	1.339,90	1.674,88
VZA200-6	2013	453	865	608	365	442	1.30	-	4.7	37.7	1.452,65	1.815,81
VZA160-7	1613	527	812	571	343	415	1.30	-	4.6	35.7	1.379,89	1.724,86
VZA180-7	1813	527	911	641	385	465	1.30	-	5.0	39.8	1.466,93	1.833,67
VZA200-7	2013	527	1010	710	427	516	1.30	-	5.5	44.0	1.599,62	1.999,54
VZA160-8	1613	601	929	653	392	475	1.30	-	5.2	40.8	1.504,00	1.880,01
VZA180-8	1813	601	1042	733	440	532	1.30	-	5.8	45.5	1.593,90	1.992,39
VZA200-8	2013	601	1155	812	488	590	1.30	-	6.2	50.2	1.746,59	2.183,25
VZA160-10	1613	749	1163	818	491	594	1.30	-	6.5	51.0	1.752,31	2.190,39
VZA180-10	1813	749	1304	917	551	666	1.30	-	7.2	56.9	1.847,91	2.309,90
VZA200-10	2013	749	1446	1017	611	739	1.30	-	7.8	62.8	2.040,56	2.550,71

Model	H mm	L mm	Thermal output				Exp. n	Classification Electric heating element Watt	V dm ³	M kg	Price RAL 9016 €	Price [Ⓞ] Cat. 1 €
			EN 442 [Ⓞ] W	70/55/24 W	55/45/24 W	55/45/20 W						

Single-layer version with fins

VZLA160-4	1613	305	616	431	257	311	1.32	-	2.6	25.6	1.469,79	1.837,23
VZLA180-4	1813	305	693	486	291	352	1.31	-	2.9	29.6	1.582,51	1.978,13
VZLA200-4	2013	305	743	521	312	378	1.31	-	3.1	32.1	1.699,50	2.124,38
VZLA160-6	1613	453	928	649	387	469	1.32	-	3.9	38.5	1.743,75	2.179,69
VZLA180-6	1813	453	1044	732	438	530	1.31	-	4.3	44.5	1.879,30	2.349,12
VZLA200-6	2013	453	1119	785	469	569	1.31	-	4.7	48.1	2.022,00	2.527,50
VZLA160-7	1613	527	1084	758	452	548	1.32	-	4.6	44.9	1.880,73	2.350,90
VZLA180-7	1813	527	1219	855	511	619	1.31	-	5.0	51.9	2.027,72	2.534,64
VZLA200-7	2013	527	1308	917	549	665	1.31	-	5.5	56.1	2.183,25	2.729,07
VZLA160-8	1613	601	1240	867	517	627	1.32	-	5.2	51.3	2.017,72	2.522,15
VZLA180-8	1813	601	1395	978	585	709	1.31	-	5.8	59.3	2.176,12	2.720,15
VZLA200-8	2013	601	1496	1049	628	760	1.31	-	6.2	64.2	2.344,51	2.930,64
VZLA160-10	1613	749	1552	1086	647	785	1.32	-	6.5	64.1	2.291,71	2.864,63
VZLA180-10	1813	749	1746	1225	733	887	1.31	-	7.2	74.1	2.472,92	3.091,14
VZLA200-10	2013	749	1872	1313	785	951	1.31	-	7.8	80.2	2.666,99	3.333,75

STUDIO COLLECTION ZEHNDER ARTEPLANO

Connection to hot water central heating system

Painted version

Model	H mm	L mm	Thermal output				Exp. n	Classification Electric heating element Watt	V dm ³	M kg	Price RAL 9016 €	Price ^① Cat. 1 €
			EN 442 ^② W	70/55/24 W	55/45/24 W	55/45/20 W						

Double-layer version

VZAD160-4	1613	305	680	476	283	344	1.32	-	4.8	31.1	1.648,14	2.060,18
VZAD180-4	1813	305	757	531	318	385	1.31	-	5.3	34.8	1.779,42	2.224,28
VZAD200-4	2013	305	833	584	349	423	1.31	-	5.8	38.5	1.907,84	2.384,80
VZAD160-6	1613	453	1025	717	427	518	1.32	-	7.1	46.7	2.121,90	2.652,37
VZAD180-6	1813	453	1141	800	479	580	1.31	-	7.9	52.3	2.295,99	2.869,99
VZAD200-6	2013	453	1255	880	527	638	1.31	-	8.8	57.7	2.467,22	3.084,04
VZAD160-7	1613	527	1197	837	499	605	1.32	-	8.3	54.5	2.358,74	2.948,43
VZAD180-7	1813	527	1333	935	559	677	1.31	-	9.2	61.0	2.554,25	3.192,83
VZAD200-7	2013	527	1466	1028	615	745	1.31	-	10.2	67.3	2.746,91	3.433,64
VZAD160-8	1613	601	1370	958	571	693	1.32	-	9.5	62.2	2.595,65	3.244,56
VZAD180-8	1813	601	1524	1069	639	774	1.31	-	10.6	69.7	2.812,54	3.515,68
VZAD200-8	2013	601	1677	1176	704	852	1.31	-	11.7	77.0	3.026,59	3.783,24
VZAD160-10	1613	749	1714	1199	714	866	1.32	-	11.9	77.8	3.069,38	3.836,73
VZAD180-10	1813	749	1908	1338	800	970	1.31	-	13.2	87.1	3.329,10	4.161,38
VZAD200-10	2013	749	2099	1472	881	1067	1.31	-	14.6	96.2	3.585,95	4.482,44

Standard scope of delivery for operation on central heating system

- Powder coating to DIN 55900, RAL 9016
- 4 x ½" connections for flow, return at bottom, vertical opposite end, left, right or centre option 50 mm
- 1 x ½" vent, top right
- Wall brackets in radiator colour:
VZA and VZLA model: CVD1, Modell VZAD: CVD0
- Packaging

Special solution on request (surcharge)	Article no.	Price €
■ Special finish to category 2 (surcharge on cat. 1)	-	146,76
■ VZAD model: Side covers firmly welded to the radiator and not removable ^③	-	112,44
■ VZAD model: Side covers for retrofitting in white RAL 9016 ^③	-	248,32
■ VZAD model: Side covers for retrofitting in special finish ^③	-	309,91
■ Stainless steel towel rail, polished	-	see page 160

EXCLUSIVE SURFACES

Refined front	Code	Basic radiators	Surcharge ^⑤ €
Stainless steel, mirror polished ^④	9516	RAL 9007	1.315,17
Stained copper	9523	RAL 8003	1.315,17
Stained brass	9521	337 Old gold	1.315,17



Stainless steel,
mirror polished
(code 9516)



Stained copper
(code 9523)



Stained brass
(code 9521)

① For special colours in categories 1 and 2, see special solutions and colour chart

② Thermal output to EN 442, ΔT 50 K (75/65/20 °C)

③ Reduced output 6%

④ Surface stainless steel 9% reduced output

⑤ Surcharge on price cat. 1

Please note the information on surfaces in the keyword list under 'Special finishes/surfaces'

STUDIO COLLECTION ZEHNDER ARTEPLANO

Operation on central heating system:

Wall mounting, VZA model

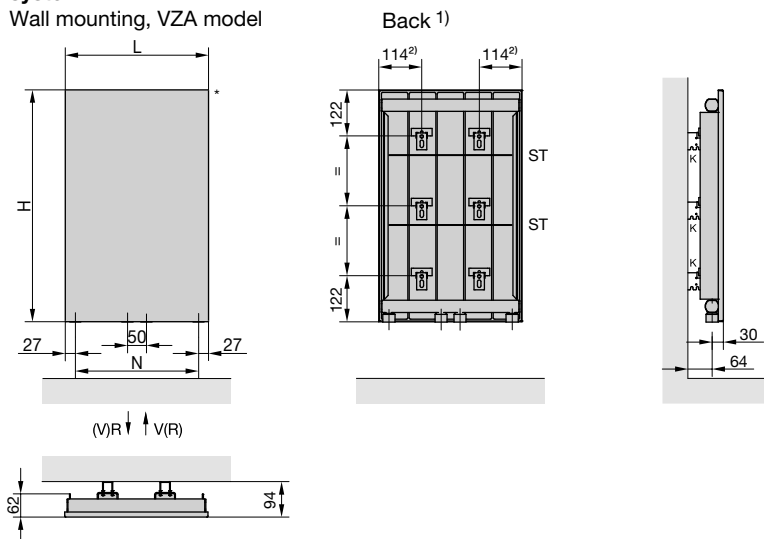

Operation on central heating system:

Wall mounting, VZLA model

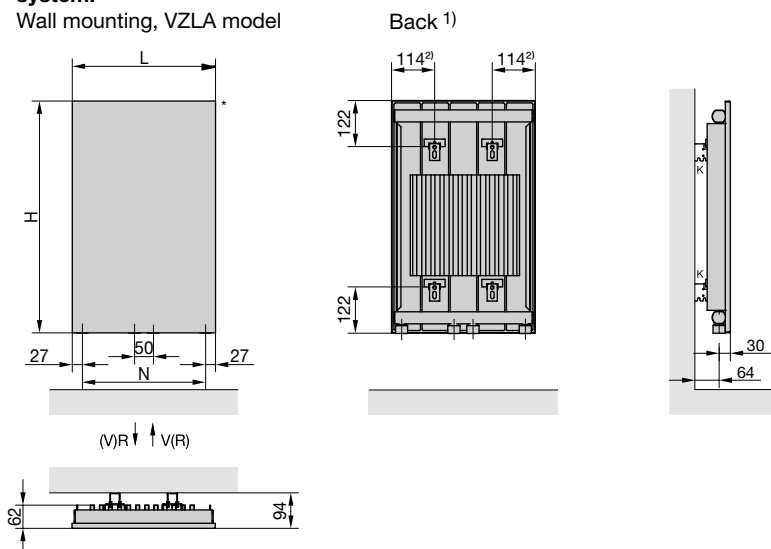

Operation on central heating system:

Wall mounting, VZAD model

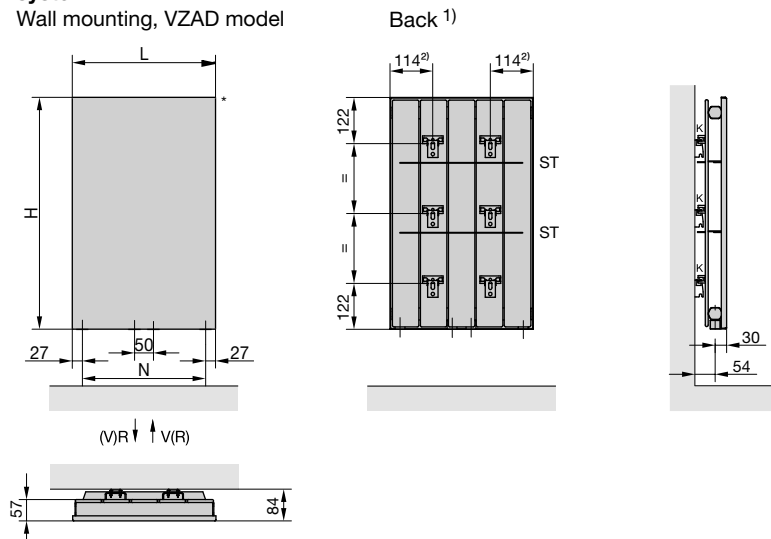

- H = Height
- L = Length
- N = Connection centre
- ST = Stabilising brace
- K = Bracket(s)
- * = Vent

Dimensions in mm

- 1) Dimensional tolerances of the fixing points ± 5 mm
- 2) 77 mm for length L = 305 mm

STUDIO COLLECTION

ZEHNDER CHIME

The athlete of the radiator world – powerful, self-assured design consisting of elegantly curved round tubes whose open side allows even very thick towels to be slid on as a convenient way of warming them. Zehnder Chime from the Studio Collection: the round design version made of hand-polished, high-quality stainless steel can be installed with the open end on the left or right. Zehnder Chime makes a bold statement in the bathroom – and has the added bonus of providing beautifully pre-warmed towels.





Radiator surface: Hand-polished stainless steel

STUDIO COLLECTION ZEHNDER CHIME



Radiator surface: Hand-polished stainless steel

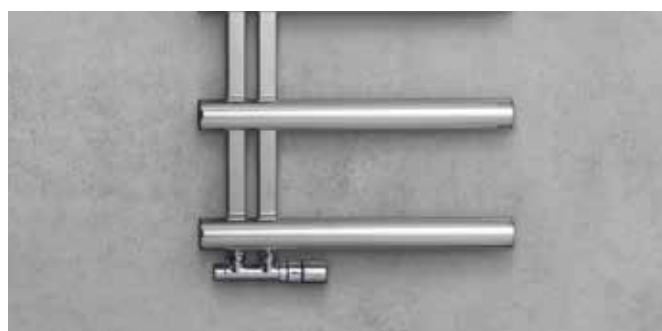

Operation on central heating system

Zehnder Chime from the Studio Collection: the round design version made of hand-polished, high-quality stainless steel can be installed with the open end on the left or right. Powerful, self-assured design consisting of elegantly curved round tubes whose open side allows even very thick towels to be slid on as a convenient way of warming them. Horizontal tubes each branch asymmetrically from the laterally arranged manifolds. Round tube Ø 51 mm, header tube 30 x 30 mm. Thermal output tested to EN 442, with CE marking. 4 x ½" female thread on the header tubes, connection size 50 mm. Flow, return at bottom, left-hand or right-hand installation option; top 2 x ½" directional air vent, screwed in at the factory for installation as right-hand version. Delivered ready to install with elegant wall brackets in chrome.

Standard scope of delivery for operation on central heating system

- Hand-polished stainless steel
- 4 x ½" connections for flow, return, vent
- 2 x directional air vent ½" screwed in at the factory for installation as right-hand version
- Elegant wall brackets in chrome
- Packaging

Operating pressure	max. 5.2 bar
Operating temperature	max. 90 °C
Height mm
Length mm
Model

Advantages

- Hand-polished stainless steel
- Ideal for hanging towels due to large tube spacing and asymmetrical tube arrangement
- Can be installed as a right-handed or left-handed version
- Easy to clean

STUDIO COLLECTION ZEHNDER CHIME

Overview of models

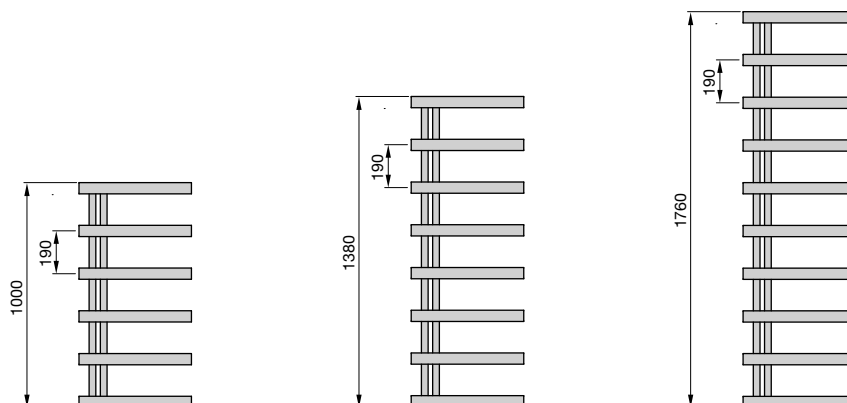

Connection to hot water central heating system

Stainless steel version

Model	H mm	L mm	Thermal output				Exp. n	Classification Electric heating element Watt	V dm ³	M kg	Price Stainless steel €
			EN 442 [Ⓞ] W	70/55/24 W	55/45/24 W	55/45/20 W					
CHZ-100-050	1000	500	276	193	114	139	1.33	-	7.1	7.3	1.167,30
CHZ-140-050	1380	500	377	272	170	203	1.20	-	9.5	9.6	1.412,28
CHZ-180-050	1760	500	438	314	194	232	1.23	-	12.0	12.0	1.700,51

Special solution on request (surcharge)	Article no.	Price €
■ Zehnder thermostat	-	see page 164
■ Zehnder valves, return screw connections and fittings	-	see page 165 onwards

Operation on central heating system:

Wall mounting, installation as right-hand version

Wall mounting, installation as left-hand version

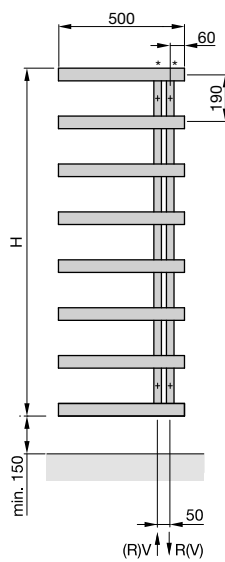
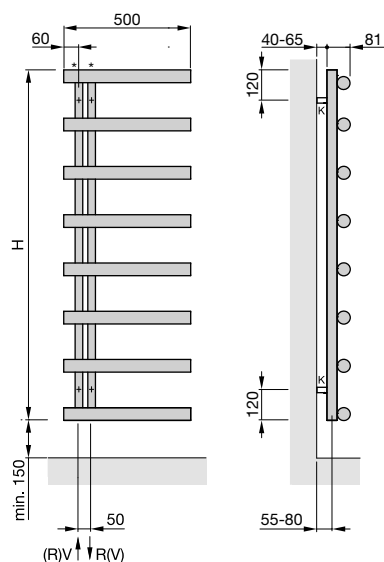

H = Height
V = Flow
R = Return
K = Bracket(s)
* = Vent

Dimensions in mm

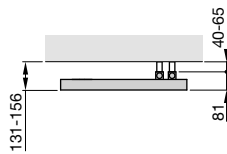
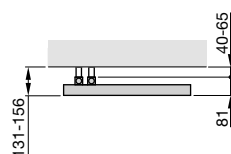

Ⓞ Thermal output to EN 442, ΔT 50 K (75/65/20 °C)

STUDIO COLLECTION

ZEHNDER DESEO VERSO

The Zehnder Deseo Verso electric glass radiator from the Studio Collection combines a modern design with exceptional comfort and outstanding functionality. The elegant black, white or even reflective heated glass front makes this decorative radiator an eye-catching feature that fits perfectly into all kinds of bathroom designs. Additional special features for users: One or two extendable towel rails, depending on the model, which can be mounted on the back of the radiator. This allows the towels to 'disappear' behind the glass front and keeps the bathroom looking neat and tidy. Every detail perfectly thought out.





Heated glass front: Black

STUDIO COLLECTION ZEHNDER DESEO VERSO



Heated glass front: Black



Heated glass front: White

Electric operation

Zehnder Deseo Verso decorative radiator, electric-only, made of safety glass – double-hardened (class B in accordance with EN 12600), includes one or two polished stainless steel towel rails (depending on model) for mounting on the back of the radiator at the specified height with extension to the right or left (can be selected for each towel rail when installing).

Operation of the heated glass front via simple control panel (modes: Surface temperature 45 °C, 55 °C, 65 °C, 2 h timer function, off), with keylock option, or using separate model 4 battery-powered infrared remote control model 4 with room temperature control (modes: frost protection, economy, comfort, individual daily or weekly programme, off).

Heated glass front available in black, white or as a mirror. Connection cable 1,8 m long with two pin plug, simple cable routing adjusted to the towel rail installation via cable clips pre-installed on the back of the decorative radiator ex works. Nominal voltage 230 volts, splash-proof IP 45.

Output W
Height mm
Length mm
Model



Remote control model 4

Advantages

- Minimalist, modern design that adds an elegant touch to the bathroom
- Practical: extendable towel rail on the back of the radiator ensures a tidy bathroom
- Heated glass front provides pleasant warmth in next to no time
- Convenient operation via control panel or remote control
- Supplied mounting template ensures easy installation
- Low energy consumption in stand-by mode (≤ 0.5 W)
- Energy-efficient and comfortable heating via innovative open window detection
- Ready-to-plug

Standard scope of delivery for electric operation

- Radiator made from safety glass with control box and cable clips pre-installed on the back
- Polished stainless steel towel rails for mounting on the back of the radiator, extension either to left or right (as selected during installation); for 1500 mm height: one towel rail; for 1750 mm height: two towel rails per radiator, with fixing material
- Infrared remote control model 4 including batteries (AAA) with selectable modes: manual (above room temperature), weekly programme, timer, frost protection, off
- Wall mounting accessories and cable clips in the colour of the radiator, or for mirror radiators: Wall bracket + cable clips in black
- Wall spacer for adjustment to the correct wall clearance
- Packaging and drilling template

STUDIO COLLECTION ZEHNDER DESEO VERSO

Electric-only operation



Model	Colour	H mm	L mm	Electrical output W	Price €
DVW-150-048/D	White	1500	475	600	2.101,88
DVB-150-048/D	Black	1500	475	600	2.101,88
DVM-150-048/D	Mirror	1500	475	600	2.237,78
DVW-175-048/D	White	1750	475	750	2.413,78
DVB-175-048/D	Black	1750	475 </tr		

Electric operation:

Wall mounting

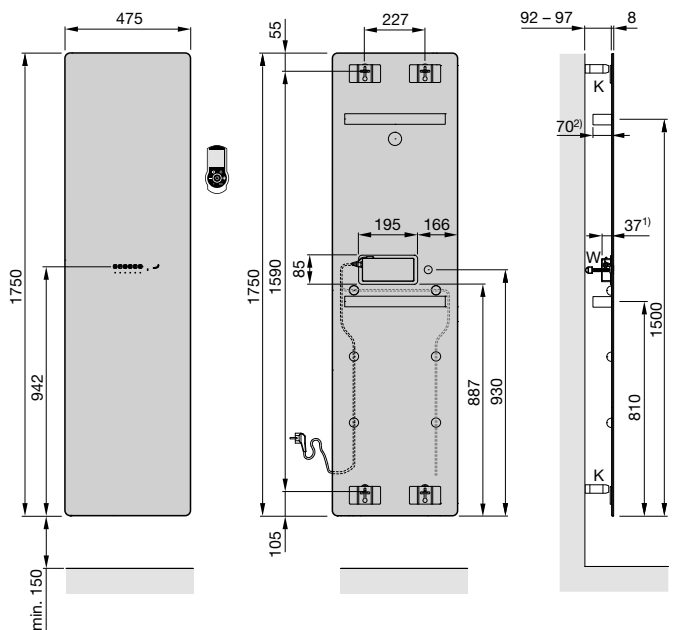
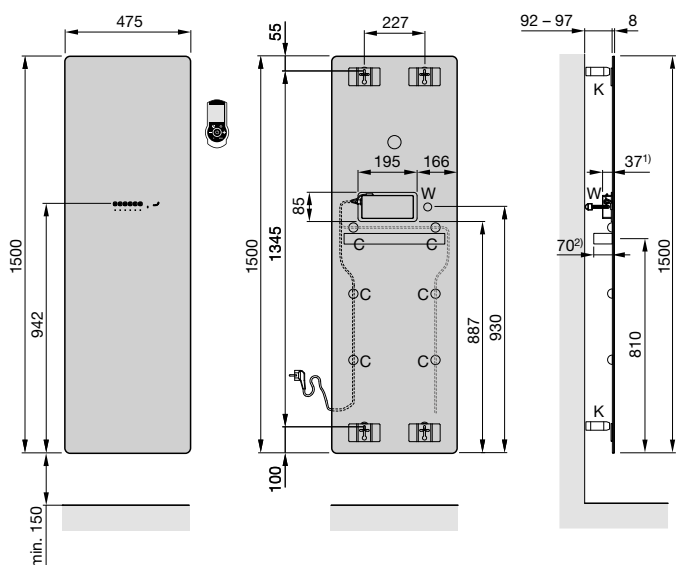

H = Height

L = Length

K = Bracket

C = Cable clip (for cable routing, see towel rail installation drawing)

W = Wall spacer

Dimensions in mm

For keywords, see 'Electric operation and Ecodesign Directive' on page 173

Towel rail for extension to left or right
as preferred

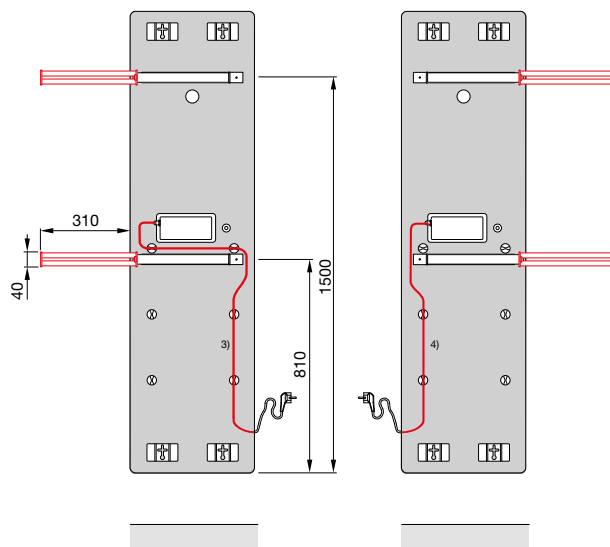
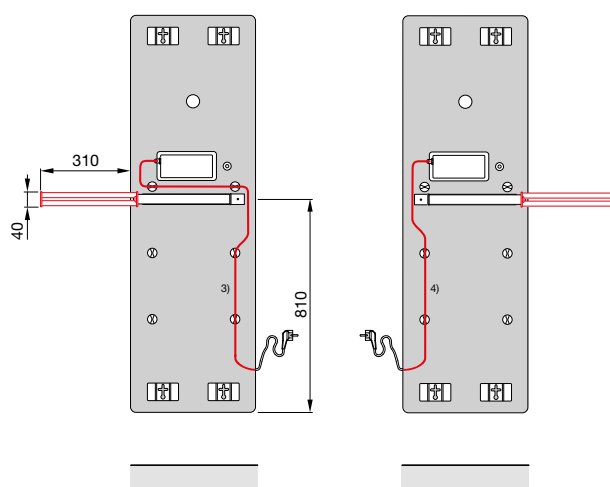

1) Back of control box to back of radiator

2) Back of towel rail to back of radiator

Cable length available in the direction of the connection
from bottom edge of radiator depending on cable routing:

3) 500 mm

4) 800 mm

STUDIO COLLECTION

ZEHNDER FOLIO BELT

With an impressive flat surface, full closed edging and gently tapered silhouette, Zehnder Folio Belt from the Studio Collection is highly appealing with its unusually light and floating appearance. The design of this radiator, which has a projection of only 16 millimetres depth, has only been made possible by the development of innovative design elements and materials. The striking flat shape of Zehnder Folio Belt is a result of innovative heating technology. The material and colour can be selected to make the radiator blend harmoniously into your interior design concept or else create a pleasing contrast. Painted surfaces or anodised aluminium allow the heat to flow elegantly and efficiently into the room, and with one or two towel rails, it also offers maximum style and comfort in the bathroom.





Radiator surface: anodised aluminium

STUDIO COLLECTION ZEHNDER FOLIO BELT



Radiator surface: anodised aluminium



Radiator surface: anodised aluminium / white matt

Operation on central heating system

The impressive Zehnder Folio Belt from the Studio Collection features an unusually light and floating appearance. The design of this radiator, which has a projection of only 16 millimetres depth, has only been made possible by the development of innovative design elements and materials.

Heating register made of copper pipe Ø 12 mm, embedded in an aluminium honeycomb construction, which is enclosed by expanded natural graphite, 45° inclined edges made of polyamide. One or two (depending on model, according to overview of models) chrome-plated towel rails 40 x 4 mm, for installation at a fixed predefined position, included in scope of delivery.

Thermal output to EN 442, with CE marking. With two connections ½" female thread for flow/return at the bottom centre, distance of 50 mm, decorative directional air vent ½" at the top rear.

Front and back made of aluminium available in all colours according to the Zehnder colour chart as well as in the specified surfaces, back with anodised aluminium finish in matt black. Delivered ready to install with elegantly shaped wall brackets in radiator colour (anodised aluminium surface: wall brackets in matt black).

Operating pressure	max. 10.0 bar
Operating temperature	max. 80 °C
Height mm
Length mm
Model

Advantages

- Innovative heating technology
- Sleek, elegant design
- Smooth surface makes for easy cleaning
- Convenient for hanging up towels

Construction

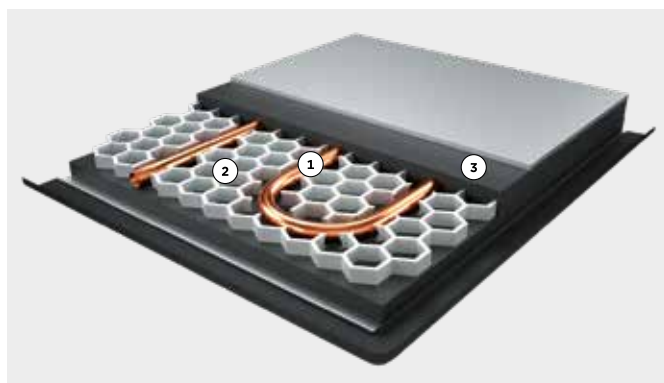

At the core of this decorative radiator is a heating register made of copper (1), embedded in an aluminium honeycomb construction (2), which is surrounded by expanded natural graphite (3). Thanks to this special, newly developed design and an innovative manufacturing technique, Zehnder was able to develop this very thin and ultra-light radiator without compromising on performance. The natural graphite used is an innovative material with ideal properties such as high thermal conductivity, low density and resistance to ageing.

STUDIO COLLECTION ZEHNDER FOLIO BELT

Overview of models

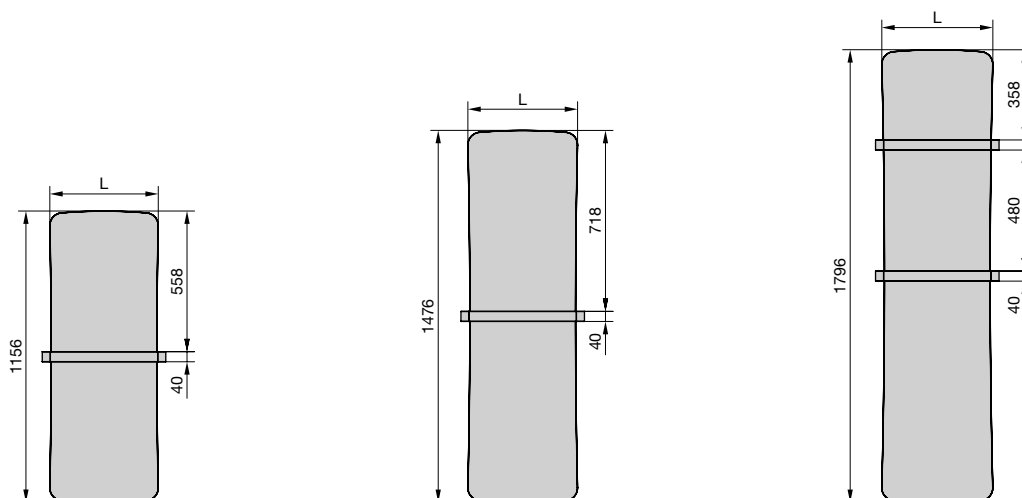

Connection to hot water central heating system

Painted version

Model	H mm	L mm	Thermal output				Exp. n	Classification Electric heating element Watt	V dm ³	M kg	Price RAL 9016 €	Price ^① Cat. 1 €
			EN 442 ^② W	70/55/24 W	55/45/24 W	55/45/20 W						
FZB-120-042	1156	430	399	288	180	215	1.20	-	0.5	6.2	1.326,01	1.657,51
FZB-150-042	1476	435	504	364	227	271	1.20	-	0.6	8.5	1.564,23	1.955,30
FZB-180-042	1796	441	614	444	277	330	1.20	-	0.6	12.8	1.750,03	2.187,54
FZB-120-052	1156	530	485	350	219	261	1.20	-	0.6	8.0	1.352,98	1.691,22
FZB-150-052	1476	535	611	441	276	329	1.20	-	0.7	10.2	1.595,70	1.994,63
FZB-180-052	1796	540	762	551	344	410	1.20	-	0.8	14.7	1.785,98	2.232,48
FZB-150-062	1476	635	718	519	324	386	1.20	-	0.8	12.0	1.646,65	2.058,31
FZB-180-062	1796	640	912	657	409	488	1.21	-	1.0	16.4	1.841,43	2.301,79
FZB-180-072	1796	740	1064	765	474	566	1.22	-	1.2	18.1	1.902,86	2.378,59

Standard scope of delivery for operation on central heating system

- Powder coating to DIN 55900, RAL 9016
- 1 or 2 chrome towel rails depending on version
- 2 x 1/2" connections at bottom, centre 50 mm
- 1/2" directional air vent
- Elegant wall brackets
- Packaging

① For special colours in categories 1 and 2, see special solutions and colour chart

② Thermal output to EN 442, ΔT 50 K (75/65/20 °C)

STUDIO COLLECTION ZEHNDER FOLIO BELT

Special solution on request (surcharge)	Article no.	Price €
■ Special finish to category 2 (surcharge on cat. 1)	-	146,76
■ Highly-polished metal surfaces: anodised aluminium	-	as in Cat. 1
■ Zehnder thermostat	-	see page 164
■ Zehnder valves, return screw connections and fittings	-	see page 165 onwards

Operation on central heating system:

Wall mounting

Back cover

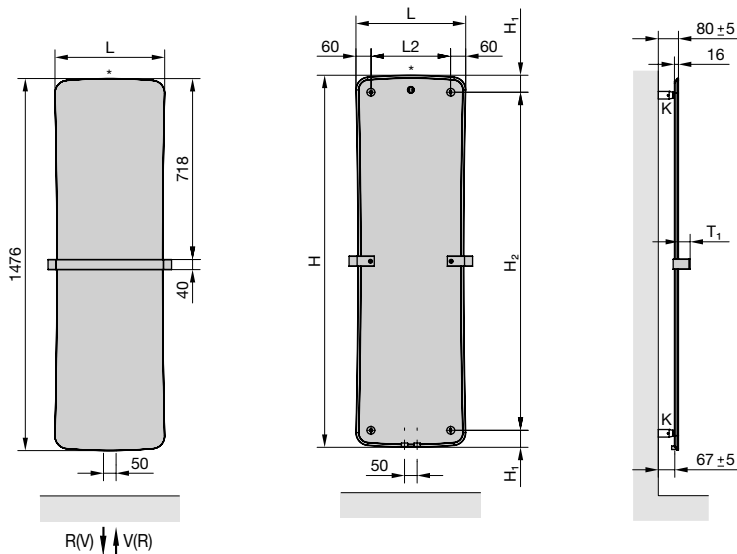

H = Height
L = Length
V = Flow
R = Return
K = Bracket(s)
* = Vent

Dimensions in mm

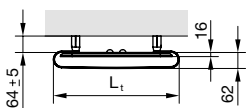

Model	H mm	L mm	H ₁ mm	H ₂ mm	L ₂ mm	L _t mm	T ₁ mm
FZB-120-042	1156	430	67	1022	310	490	46
FZB-150-042	1476	435	67.5	1341	315	490	46
FZB-180-042	1796	441	67.5	1661	321	490	46
FZB-120-052	1156	530	72	1012	410	590	48
FZB-150-052	1476	535	72.5	1331	415	590	48
FZB-180-052	1796	540	73	1650	420	590	48
FZB-150-062	1476	635	79	1318	515	690	50
FZB-180-062	1796	640	79.5	1637	520	690	50
FZB-180-072	1796	740	87	1622	620	790	52

STUDIO COLLECTION

ZEHNDER FOLIO GLASS

Whether it's black, white or even in the form of a mirror, Zehnder Folio Glass from the Studio Collection integrates itself harmoniously into its interior environment with its elegant glass finish. With an extremely flat body of only 8 mm, fully closed edges and a gently tapering silhouette, the Zehnder Folio Glass appeals with its unusually light appearance. The design of the glass surface floating in the room is the result of innovative technology. Controlled either by remote control or directly on the surface, it delivers maximum style and comfort. Zehnder Folio Glass – crystal-clear design for your home.





STUDIO COLLECTION ZEHNDER FOLIO GLASS



Radiator surface: Black gloss



Radiator surface: White gloss

Electric operation

Whether it's black, white or even in the form of a mirror, Zehnder Folio Glass from the Studio Collection integrates itself harmoniously into its interior environment with its elegant glass finish. With an extremely flat body of only 10 mm in depth, fully closed edges and a gently tapering silhouette, the Zehnder Folio Glass appeals with its unusually light appearance.

The design of the glass surface floating in the room is the result of innovative technology. Glass finish made of laminated safety glass of 2 x 4 mm, with an integrated electrically operated heating film. One or two chrome-plated towel rails can be ordered separately. For retrofitting at a fixed predefined position. Operation via control element (control panel) or chronosonda. Splash-proof IP44, mains power supply 230 V. Connection cable 1.2 m in length with two pin plug.

White cable and plug, cable outlet downwards. Front available in black gloss, white gloss, mirror. Delivered ready to install with elegant wall brackets in black.

Output W
Height mm
Length mm
Model

Advantages

- Minimalist, modern design that adds an elegant touch to the bathroom
- Intuitive, integrated control on the surface (control panel)
- Operation via control panel and remote control possible
- Durable safety glass
- Heated glass front provides pleasant warmth in next to no time
- Optionally with towel rails in chrome
- Ready-to-plug

Standard scope of delivery for electric operation

- Glass surface made of laminated safety glass in glossy black, glossy white or as a mirror
- Remote control, with selectable modes: frost protection, economy, comfort, automatic, off, room temperature control, daily and weekly programme
- Control element (control panel) with 3 temperature levels (control of surface temperature) 45 °C, 55 °C, 65 °C, timer: 2 hours at 65 °C
- Mounting accessories in radiator colour or black for mirror radiators
- Wall spacer for adjustment to the correct wall clearance
- Packaging



Remote control model 4

STUDIO COLLECTION ZEHNDER FOLIO GLASS

Electric-only operation



Model	Colour	H	L	Electrical output W	Price €
		mm	mm		
FZW-180-042/D	White	1796	441	650	1.698,89
FZB-180-042/D	Black	1796	441	650	1.698,89
FZM-180-042/D	Mirror	1796	441	650	1.698,89
FZW-180-052/D	White	1796	540	800	1.898,77
FZB-180-052/D	Black	1796	540	800	1.898,77
FZM-180-052/D	Mirror	1796	540	800	1.898,77

Special solution on request (surcharge)	Article no.	Price €
■ Chrome-plated towel rail for L = 441	468438	242,58
■ Chrome-plated towel rail for L = 540	468448	256,85

Electric operation:

Wall mounting with optional towel rail

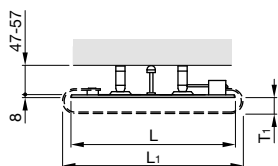
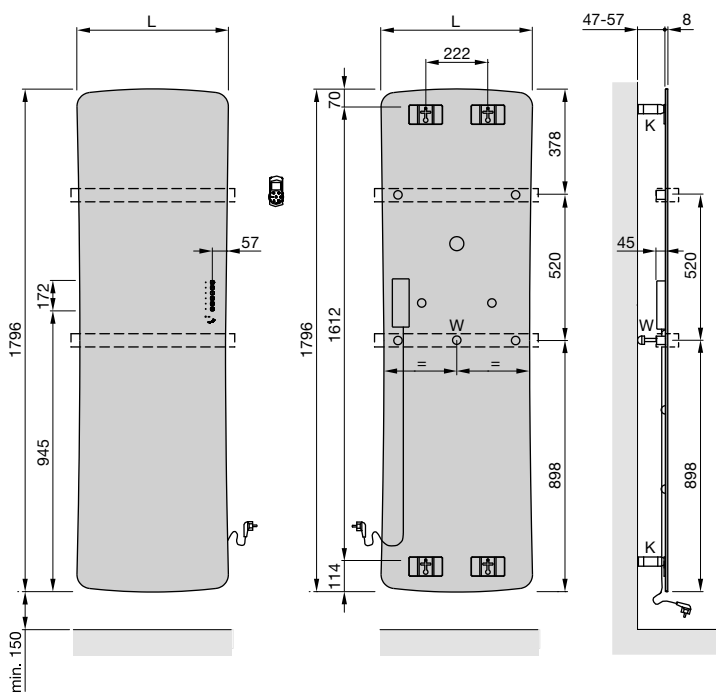

- H = Height
- L = Length
- K = Bracket
- W = Wall spacer
- L₁ = 490 for L = 441, 590 for L = 540
- T₁ = 46 for L = 441, 48 for L = 540

Dimensions in mm

For keywords, see 'Electric operation and Ecodesign Directive' on page 173

STUDIO COLLECTION

ZEHNDER FOLIO HYBRID

With an impressive flat surface, full closed edging and gently tapered silhouette, Zehnder Folio Hybrid from the Studio Collection is highly appealing with its unusually light and floating appearance. The design of this radiator, which has a projection of only 16 millimetres deep, has only been made possible by the development of innovative design elements and materials. The combination of a glossy and a matt surface allows the technology behind it to shine through: an electrically operated infrared heating element made of glass is located in the middle of the radiator, the rapid reaction time of which enables drying or warming of towels in the shortest time possible. The surrounding radiator is connected to the central heating system and provides cosy warmth in the room. With up to two chrome-plated towel rails, Zehnder Folio Hybrid also lends maximum style and comfort to the bathroom. Zehnder Folio Hybrid – the best of two heating philosophies.





Radiator surface: Black

STUDIO COLLECTION ZEHNDER FOLIO HYBRID



Radiator surface: White



Radiator surface: Black

Hybrid operation

Zehnder Folio Hybrid from the Studio Collection combines two heating systems in one radiator. The design of this radiator, which has a projection of only 16 millimetres deep, has only been made possible by the development of innovative design elements and materials.

Heating register made of copper pipe Ø 12 mm, embedded in an aluminium honeycomb construction, which is enclosed by expanded natural graphite, 45° inclined edges made of polyamide. Glass finish made of laminated safety glass measuring 2 x 4 mm, with an integrated electrically operated heating film. The two heating systems (radiator and heating element) can be operated independently of each other. One or two (depending on model, according to overview of models) chrome-plated towel rails 40 x 4 mm, for installation at a fixed predefined position, included in scope of delivery. Thermal output to EN 442, with CE marking. With two connections ½" female thread for flow/return at the bottom centre, distance of 50 mm, decorative directional air vent ½" at the top rear. Operation of heating element via control element (control panel). Splash-proof IP45, protection class II, mains connection 230 V. Connection cable (1.1 m) with Euro plug. White cable and plug, cable outlet towards the back. Front and back in aluminium available in white matt (0556) and black matt (0557). Heating element surface: Glass, white gloss and black gloss. Delivered ready to install with elegant wall brackets in radiator colour.

Operating pressure	max. 10.0 bar
Operating temperature	max. 80 °C
Height mm
Length mm
Model

Advantages

- The two heating systems can be operated independently of each other.
- Sleek, elegant design
- Smooth surface makes for easy cleaning
- Convenient for hanging up towels

Construction



The decorative radiator consists of two different heating system technologies. The outer part is connected to the hot water central heating system. At the core of this system is a heating register made of copper (1), embedded in an aluminium honeycomb construction (2), which is surrounded by expanded natural graphite (3). The natural graphite used is an innovative material with ideal properties such as high thermal conductivity, low density and resistance to ageing. The inner part of the radiator consists of a heating film (4), which is sandwiched between two thin glass plates (5) of 4 mm each. Thanks to this special, newly developed design and an innovative manufacturing technique, Zehnder was able to develop this very thin and ultra-light radiator without compromising on performance.

STUDIO COLLECTION ZEHNDER FOLIO HYBRID

Overview of models

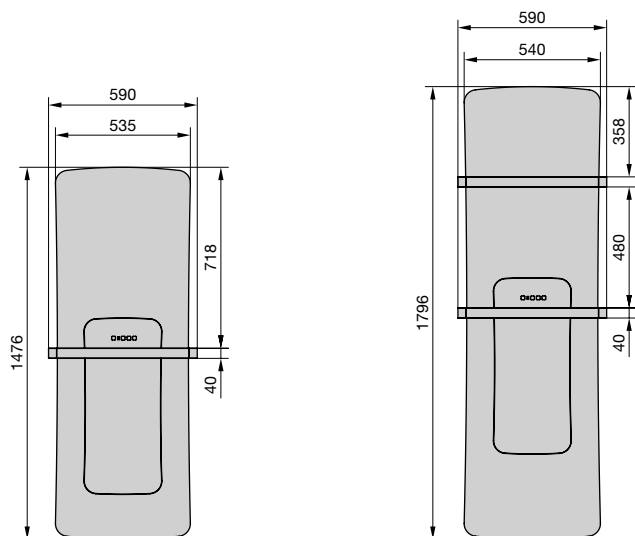

Connection to hot water central heating system / electric operation

Painted version

Model	H mm	L mm	Thermal output				Exp. n	Electrical output W	V dm ³	M kg	Price €
			EN 442① W	70/55/24 W	55/45/24 W	55/45/20 W					
White matt (0556) / white gloss (radiator / heating element)											
FZHW-150-052/D	1476	535	514	371	232	276	1.20	100	0.5	14.1	1.921,07
FZHW-180-052/D	1796	540	648	463	285	341	1.24	100	0.6	17.7	2.092,12
Black matt (0557) / black gloss (radiator / heating element)											
FZHB-150-052/D	1476	535	514	371	232	276	1.20	100	0.5	14.1	1.921,07
FZHB-180-052/D	1796	540	648	463	285	341	1.24	100	0.6	17.7	2.092,12

Special solution on request (surcharge)	Article no.	Price €
■ Zehnder thermostat	-	see page 164
■ Zehnder valves, return screw connections and fittings	-	see page 165 onwards

Standard scope of delivery for hybrid operation

- Powder-coated radiator according to DIN 55900
Matt white or matt black
- Glass finish made of laminated safety glass in white gloss or black gloss
- 1 or 2 chrome towel rails depending on version
- 2 x ½" connections at bottom, centre 50 mm
- ½" directional air vent
- Integrated control element (control panel) with the following functions:
Timer 30, 60 or 90 minutes, Off,
Surface temperature: max. 65 °C
- Elegant wall brackets
- Packaging

① Thermal output to EN 442, ΔT 50 K (75/65/20 °C)

STUDIO COLLECTION ZEHNDER FOLIO HYBRID

Hybrid operation:
Wall mounting

Back cover

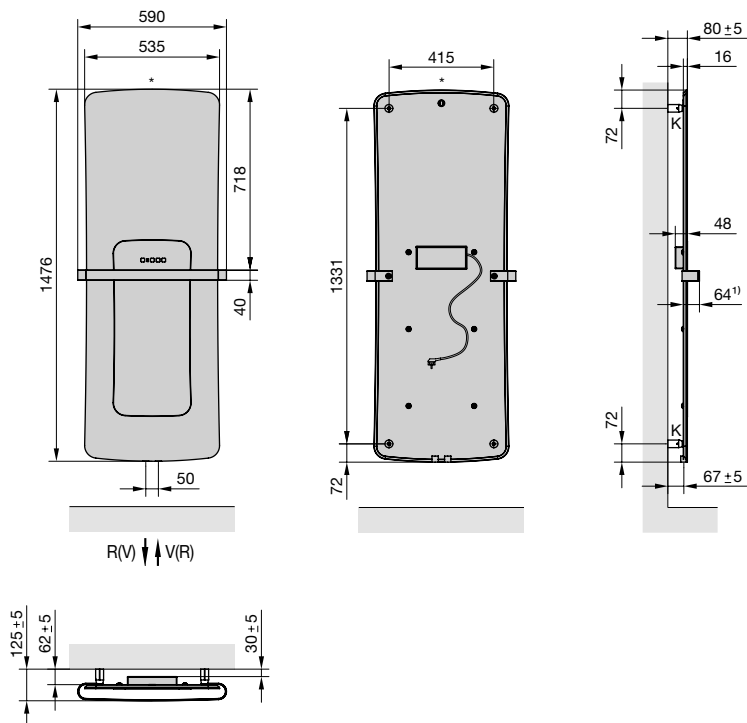

Hybrid operation:
Wall mounting

Back cover

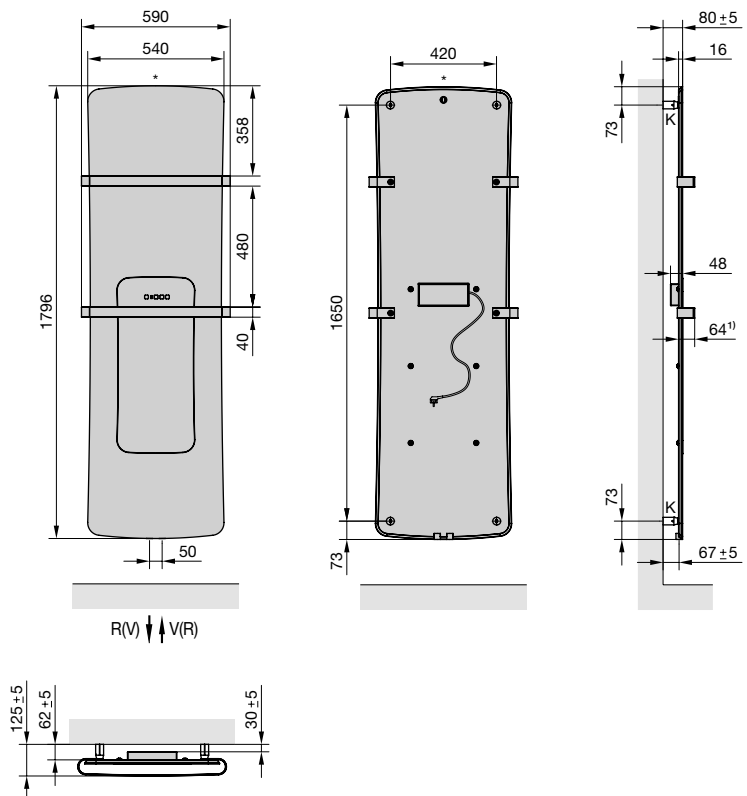

V = Flow
R = Return
K = Bracket(s)
* = Vent

Dimensions in mm

¹⁾ Rear edge of radiator up to front edge of towel rail

STUDIO COLLECTION

ZEHNDER ZENIA

Zehnder Zenia from the Studio Collection is an electric towel warmer, towel dryer, infrared radiator and boost heater all-in-one – in the form of an integrated unit that perfectly blends into modern bathroom architecture thanks to its minimalist design. The revolutionary Zehnder Zenia thermal comfort unit supplies pleasant heat quickly and ensures ultimate comfort heating in your bathroom independently of the central heating system. At the same time, you can dry and warm towels behind a visually appealing heated glass door. Available in white and black.



DESIGN PLUS
powered by: **ISH**





Heated glass front: White

STUDIO COLLECTION ZEHNDER ZENIA



Heated glass front: Black



Heated glass front: White

Electric operation

Zehnder Zenia thermal comfort unit for rapidly heating and drying textiles, for operation in combination with a room heating system that covers the basic heat requirements. Zehnder Zenia comprises a housing for pre-assembly and thermal comfort unit for final assembly. Option to select from either a rectangular frame or outer case as the housing for pre-assembly. Rectangular frame made of galvanised sheet steel for mounting the thermal comfort unit as an in-wall installation (in-wall systems, vertical frames or solid constructions) or for on-site integration into furniture. Aluminium decorative grille, painted, for mounting the thermal comfort unit as an on-wall installation.

Thermal comfort unit includes an inner case and an infrared heated glass front with the option to have the hinge on the left or right. Plastic inner case with integrated boost heater and glass cover with control panel and Bluetooth module. Heated glass door with internal towel rail for warming and drying textiles. Towel rail offers space for two towels of max. 140 x 70 cm each. Thermal comfort unit can either be operated via a simple control panel or an individually configurable app (available for both iOS and Android operating systems). Option of individual or combined operation of heated glass door (heated front face) and boost heater (functions: Boost function, towel warming or fast drying options, each with their own pre-set running time that can be modified via the app).

Thermal comfort unit with glass cover and infrared heated glass front available in black or white. Mains power supply for boost heater and heated glass door via common connection cable and mains power supply plug for connecting to on-site electrical connection box in the wall for a nominal voltage of 230 volts, total nominal output of 1225 W, splash-proof to IP 44 standards, complete with CE marking in accordance with DIN EN 60335 (Household and similar electrical appliances – Safety), suitable for optional connection in accordance with protection class I or II (DIN EN 61140), hinges certified in accordance with DIN EN 15570, heated glass door tested in accordance with VDI 6036 (requirements class 2), heated glass door made of safety glass – double-hardened (class B1 in accordance with EN 12600), system requirements for operation via app: iOS version 9.0 onwards, Android version 4.3 and 5.x onwards, Bluetooth from BLE onwards = Bluetooth 4.0 Low Energy.

Housing for pre-assembly model
Thermal comfort unit for final assembly model

Advantages

- Hidden storage space ensures a tidy bathroom
- Heat readily available on demand for pre-heating rooms and towels with the integrated boost heater
- Radiant heat from the heated glass door creates a feeling of cosiness
- The intelligent drying function significantly reduces the build-up of bacteria on damp towels and textiles
- User-friendly operation with individual configuration options via an intuitive control panel or the app
- Smooth surfaces make for easy cleaning
- Low energy consumption of ≤ 0.5 W in stand-by mode for increased energy efficiency

STUDIO COLLECTION ZEHNDER ZENIA

Overview of models

Electric-only operation

Thermal comfort unit for final assembly



Model	Colour	H mm	L mm	Boost heater output W	Heated glass door Electric output W	Price €
With heated glass door hinged on the right						
ZENRW-100-045/X	White	1000	450	1000	225	2.183,54
ZENRB-100-045/X	Black	1000	450	1000	225	2.183,54
With heated glass door hinged on the left						
ZENLW-100-045/X	White	1000	450	1000	225	2.183,54
ZENLB-100-045/X	Black	1000	450	1000	225	2.183,54

Thermal comfort unit for final assembly

Hinge on left

Hinge on right

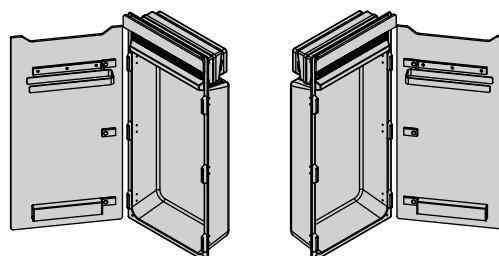

Standard scope of delivery for thermal comfort unit

- Plastic inner case painted in RAL 000 25 00
- Boost heater with filter housing that can be removed for cleaning
- Glass cover with control panel and Bluetooth module
- Heated glass door with the option to have the hinge on the left or right and a mains power supply plug for connecting to the control box in the inner case
- Hinges with soft-close function including fixings to mount and align the door on the inner case
- Brushed stainless steel towel rail with fixings
- Glass cover and heated glass door in a single colour – either black or white
- Connection cable with mains power supply plug
- Packaging

Housing for pre-assembly

Model	H mm	L mm	Price €
Rectangular frame (required for in-wall installation or integration into bathroom furniture, etc.)			
ZENFRM-100-045	977	430	228,96
Outer case (required for on-wall installation)			
ZENFRD-100-045	1003	451	515,16

Housing for pre-assembly
Rectangular frame

Outer case

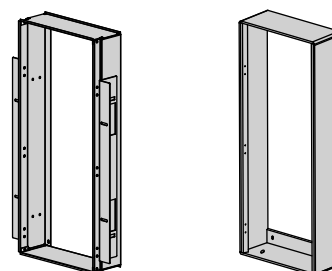

Standard scope of delivery for rectangular frame

- 4-part rectangular frame made of galvanised sheet steel complete with slots for mounting in an in-wall system
- 2 galvanised mounting brackets for mounting and aligning the rectangular frame to surrounding components
- Mains power supply socket for connecting to on-site electrical connection box
- Mounting accessories
- Cardboard cover for protection
- Packaging

Standard scope of delivery for outer case

- Single-piece, aluminium outer case, surface painted in white aluminium, complete with fixings on the back for mounting on prefabricated walls
- Mains power supply socket for connecting to on-site electrical connection box
- Mounting accessories
- Packaging

For keywords, see 'Electric operation and Ecodesign Directive' on page 173

STUDIO COLLECTION ZEHNDER ZENIA

Rectangular frame (required for in-wall installation or integration into bathroom furniture, etc.):

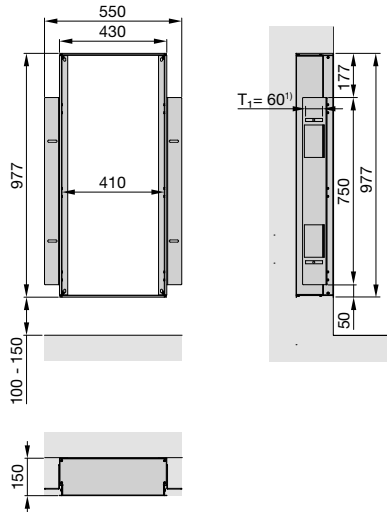

Outer case (required for on-wall installation):

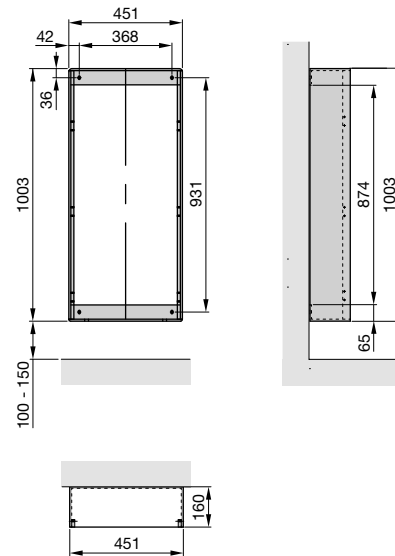

1) T_1 = Depth adjustment of rectangular frame

Thermal comfort unit for final assembly:

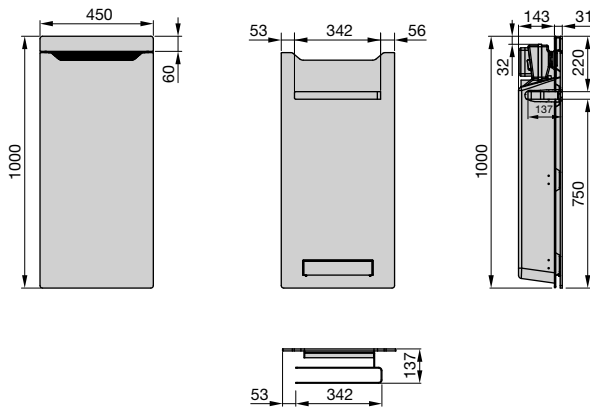

Zehnder Zenia with in-wall installation

Zehnder Zenia with on-wall installation

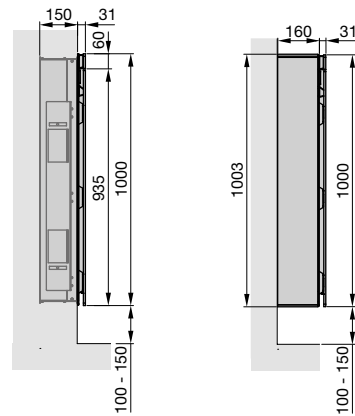

Hinge on left

Hinge on right

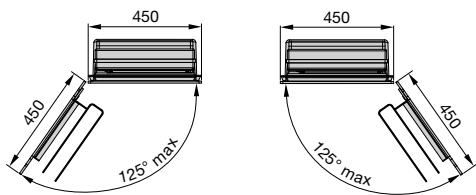

Dimensions in mm

STUDIO COLLECTION ZEHNDER ZENIA

Installation options:
In-wall installation with rectangular frame



In-furniture installation with rectangular frame



On-wall installation with outer case



Design of thermal comfort unit:

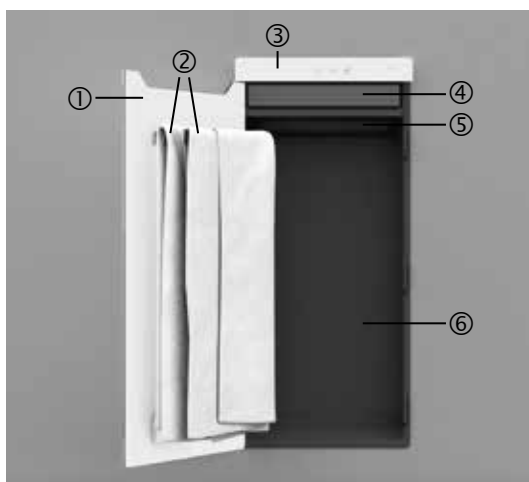

- ① Heated glass door with soft-close hinge
- ② Towel rail for hanging a maximum of two large bath towels of 140 x 70 cm
- ③ Glass cover with control panel and Bluetooth module
- ④ Suction area of the integrated boost heater with removable filter housing
- ⑤ Outlet area of the integrated boost heater
- ⑥ Easy-to-clean, plastic inner case

Functions:

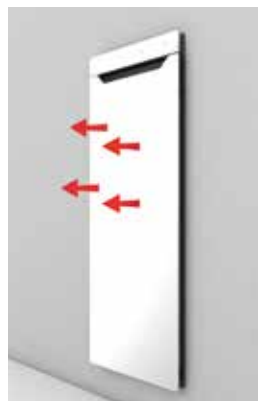

Pleasant radiant heat provided by integrated heated glass door.



Suction of room air beneath the glass cover by the boost heater. Warm, even airflow from above warms and dries textiles quickly.

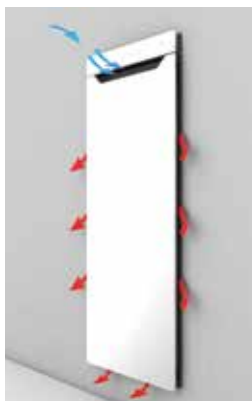

Even, gentle distribution of the heated air via an outlet behind the heated glass door.

Operation:



Straightforward selection of the four functions on the control panel. The intelligent app control also offers a range of additional functions: Remote control, daily and weekly programmes, options to change the factory settings, and support features (including video instructions for filter replacement and help with fault notifications).

STUDIO COLLECTION ZEHNDER ZENIA

Integration in special burgbad furniture



**PREMIUM
AND
QUALITY
COLLECTION**

Premium Collection

from page 54

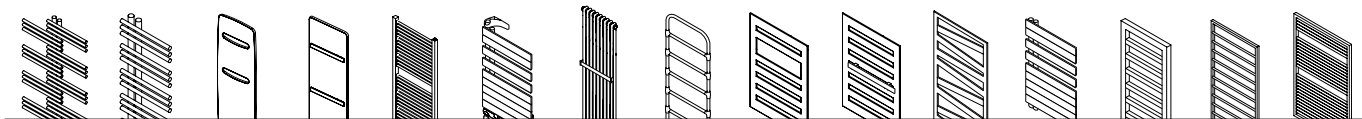

Quality Collection

from page 98

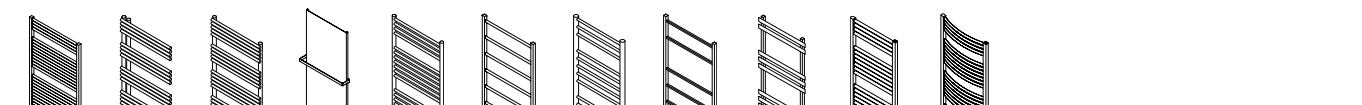

Zehnder Yucca



Radiator surface: Chrome

Operation on hot water central heating system

Zehnder Yucca decorative radiator made from horizontally arranged precision steel tubes and vertical header tubes, without visible welds and fully welded due to capstan welding technology. Sets of 3 horizontal tubes each branch symmetrically, alternately left and right, from the centrally arranged manifolds. Towels can be slid in from the side to warm or dry. Single or double-layer version. Header tubes Ø 30 mm, horizontal tubes Ø 20 mm.

Thermal outputs to EN 442, with CE marking.
4 x 1/2" connection at the ends of the header tubes for flow, return, electric heating element and venting. Connection size 50 mm, suitable for using a special connection fitting in single or twin-tube operation. Radiator with powder coating, in colour RAL 9016 as standard, in special colour or chrome on request. Delivered ready to install with matching wall brackets in colour of radiator.

Operating pressure	max. 12,0 bar
Operating temperature	max. 110°C
Height mm
Length mm
Model

Benefits

- Small depth
- Easy to clean (lambswool cleaning brush)
- Ideal for hanging up towels
- Rounded edges
- Transparent look
- Connection from top possible
- Dual energy operation with connection fitting possible

Electric operation

Zehnder Yucca decorative radiator, electric-only, made from horizontally arranged precision steel tubes and vertical header tubes. Sets of 3 horizontal tubes each branch symmetrically, alternately left and right, from the centrally arranged manifolds.

With integrated electric heating element RACY-C in left hand header tube at bottom. Degree of protection IP44 (splash-proof), for mains supply of 230 V. Connection cable (1,2 m) with Euro plug. Decorative radiator filled with heat transfer fluid. Separate, battery-operated remote control device model 2 for controlling the room temperature. Radiator with powder coating, in colour RAL 9016 as standard, in special colour or chrome on request. Delivered ready to install with matching wall brackets in colour of radiator.

Output Watt
Height mm
Length mm
Model

Special benefits for electric operation with RACY-C

- Remote control device can be positioned as required
- Regulated room temperature
- Comfortable operation as needed by customisable daily and weekly programmes
- Energy-efficient and comfortable heating via innovative open window detection
- Low energy consumption in stand-by mode ($\leq 0,5 W$)
- Keylock can be activated as required
- Timer function for up to 2 hours
- Ready-to-plug

Zehnder Yucca

Overview of models

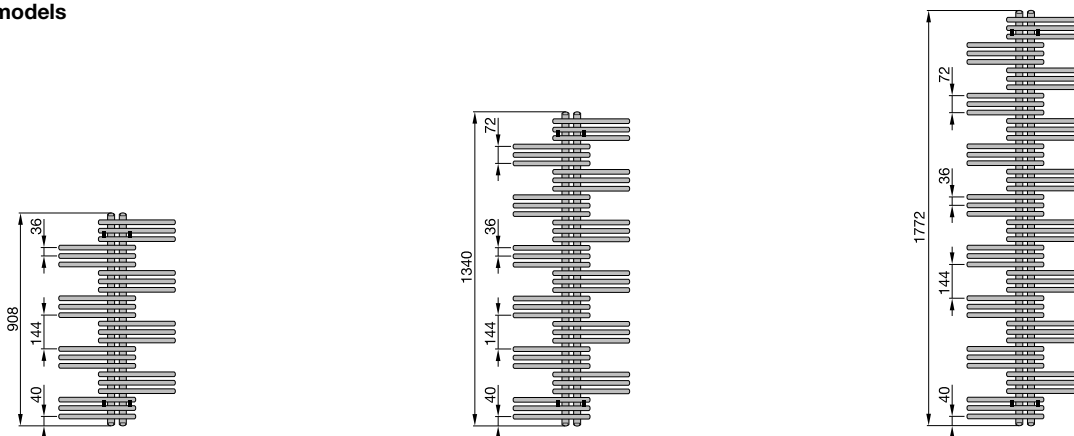

Connection to hot water central heating system or for dual energy operation*

Painted version

Model	H mm	L mm	Thermal output				Exp. n	Classification Electric heating element Watt	V dm ³	M kg	Price RAL 9016 €	Price ^① Cat. 1 €
			EN 442 ^③ W	70/55/24 W	55/45/24 W	55/45/20 W						
Single-layer version												
YS-090-050	908	500	324	230	140	168	1,27	300	2,6	8,4	888,89	1.111,12
YS-130-050	1340	500	477	339	207	249	1,26	300	4,0	12,4	1.046,41	1.308,03
YS-180-050	1772	500	621	443	271	325	1,25	600	5,2	16,6	1.256,42	1.570,53
YS-130-060	1340	600	541	385	235	282	1,26	300	4,3	14,0	1.089,61	1.362,02
YS-180-060	1772	600	706	503	308	370	1,25	600	5,7	18,6	1.306,56	1.633,21
YS-130-080	1340	800	661	470	287	345	1,26	600	5,1	17,1	1.098,89	1.373,62
YS-180-080	1772	800	863	615	377	452	1,25	600	6,7	22,7	1.318,21	1.647,76
Double-layer version												
YSD-090-050	908	500	484	339	203	246	1,31	300	4,2	14,8	1.110,58	1.388,23
YSD-130-050	1340	500	717	506	305	368	1,29	600	6,4	22,0	1.308,86	1.636,08
YSD-180-050	1772	500	926	657	399	480	1,27	900	8,4	29,4	1.570,16	1.962,71
YSD-130-060	1340	600	823	580	350	423	1,29	600	7,1	25,1	1.361,36	1.701,70
YSD-180-060	1772	600	1063	754	458	551	1,27	900	9,4	33,4	1.633,16	2.041,45
YSD-130-080	1340	800	1024	722	435	526	1,29	900	8,5	31,2	1.538,70	1.923,37
YSD-180-080	1772	800	1322	937	570	686	1,27	1200	11,4	41,4	1.780,19	2.225,24

Chrome-plated version

Model	H mm	L mm	Thermal output				Exp. n	Classification Electric heating element Watt	V dm ³	M kg	Price Chrome €
			EN 442 ^③ W	70/55/24 W	55/45/24 W	55/45/20 W					
Single-layer version											
YSC-090-050	908	500	229	161	97	118	1,29	300	2,6	8,4	1.922,03
YSC-130-050	1340	500	330	233	140	169	1,29	300	4,0	12,4	2.079,31
YSC-180-050	1772	500	431	303	182	220	1,30	300	5,2	16,6	2.290,35
YSC-130-060	1340	600	377	266	160	194	1,29	300	4,3	14,0	2.122,69
YSC-180-060	1772	600	493	347	208	252	1,30	300	5,7	18,6	2.342,99
YSC-130-080	1340	800	465	328	198	239	1,29	300	5,1	17,1	2.132,90
YSC-180-080	1772	800	608	428	257	311	1,30	600	6,7	22,7	2.355,75

* Maximum operating pressure for dual energy operation mode is 4 bar
 ① For special colours in categories 1 and 2, see "Special solutions" and "Colour chart"
 ③ Thermal output to EN 442, ΔT 50 K (75/65/20°C)

Electric-only operation



Painted version

Model	H ^③	L	Classification Electric heating element Watt	Price	Price ^①
	mm			RAL 9016 €	Cat. 1 €

Single-layer version

YSE-090-050/GD	933	500	300	1.831,51	2.106,24
YSE-130-050/GD	1365	500	500	1.979,67	2.276,62
YSE-130-060/GD	1365	600	500	2.022,32	2.325,67
YSE-180-060/GD	1797	600	750	2.330,94	2.680,58
YSE-130-080/GD	1365	800	500	1.979,67	2.276,62
YSE-180-080/GD	1797	800	750	2.344,41	2.696,07

Chrome-plated version

Model	H ^③	L	Classification Electric heating element Watt	Price
	mm			Chrome €

Single-layer version

YSEC-090-50/GD	933	500	300	2.825,45
YSEC-130-50/GD	1365	500	300	2.973,35
YSEC-130-60/GD	1365	600	300	3.016,20
YSEC-180-60/GD	1797	600	500	3.328,05
YSEC-130-80/GD	1365	800	300	2.974,47
YSEC-180-80/GD	1797	800	500	3.342,61

Standard scope of delivery for hot water central heating system

- Powder coating to DIN 55900, RAL 9016
- 4 x ½" connections for flow, return, venting
- 2 x ½" directional air vent
- Mounting accessories in colour of radiator
- Packaging

Standard scope of delivery for electric operation

- Powder coating to DIN 55900, RAL 9016
- Filled with non-flammable heat-transfer fluid (frost-proof to -10°C)
- With integrated electric heating element RACY-C, with remote control device, incl. battery, with selectable operating modes: manual (above room temperature), weekly programme, timer, off
- Electric heating element cover in colour of radiator
- Mounting accessories in colour of radiator
- Packaging

Special solution on request (surcharge)	Article number	Price €
■ Special finish to category 2 (surcharge on cat. 1)	6500011640	146,76
■ Galvanized and painted	-	On request
■ Electric heating element for dual energy operation 	-	See page 161
■ Accessories	-	See page 160
■ Lambswool cleaning brush	601040	60,41
■ Connection fitting with short cover (operation on central heating system only), cover in white	976021	172,59
■ Connection fitting with short cover (operation on central heating system only), cover in special finish	976029	184,97
■ Connection fitting with short cover (operation on central heating system only), cover in chrome	976028	229,18
■ Connection fitting with long cover (for dual energy operation with WIVAR II), cover in white	976031	172,59
■ Connection fitting with long cover (for dual energy operation with WIVAR II), cover in special finish, incl. cover parts set	976039	233,28
■ Connection fitting with long cover (for dual energy operation with WIVAR II), cover in chrome, incl. cover parts set	976038	289,54
■ Zehnder thermostat DH, M 30 x 1,5, white	819050	35,02
■ Zehnder thermostat DH, M 30 x 1,5, chrome	819058	53,36
■ Zehnder valves and lockshield valves	-	See p. 165 onwards

① For special colours in categories 1 and 2, see "Special solutions" and "Colour chart"

③ Total height incl. electric heating element

Operation on hot water central heating system:

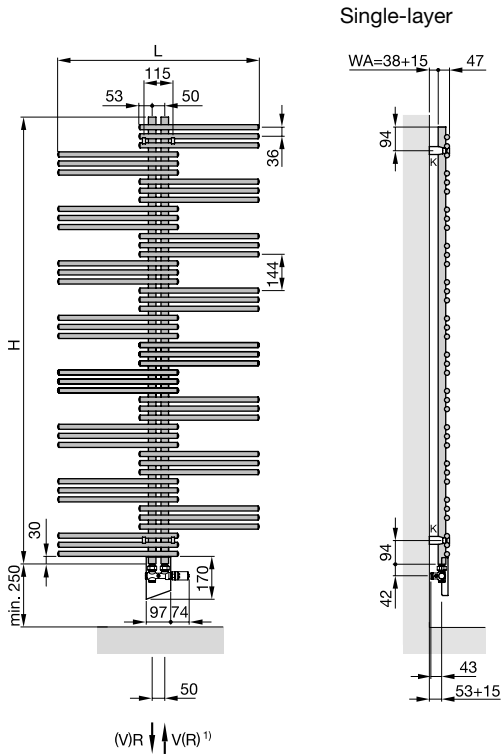

Electric operation: with heating element RACY-C

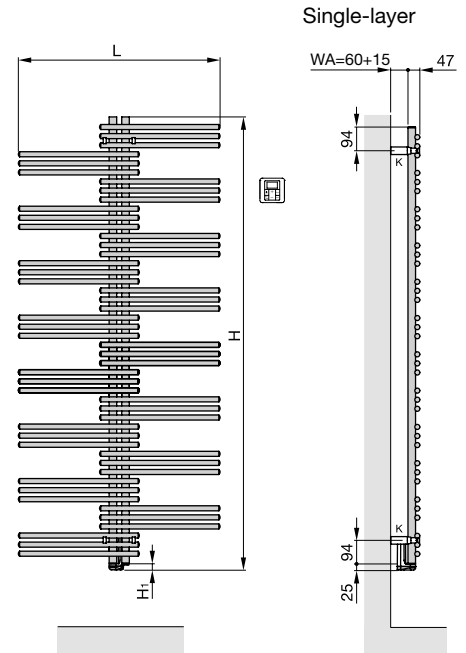

Dual energy operation:

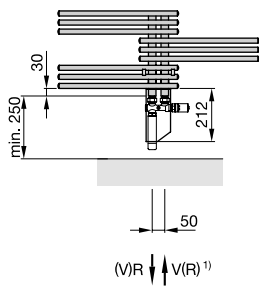

- H = Height
- H₁ = 25 mm
- L = Length
- K = Bracket
- WA = Wall clearance
- V = Flow
- R = Return

1) Flow is possible on both sides of the connection fitting

Dimensions in mm

Detail: Connection fitting with long cover and integrated electric heating element WIVAR II. Maximum operating pressure for dual energy operation is 4 bar.

Zehnder Yucca Asym



Radiator surface: Chrome



Dual energy operation with Wivar II heating element

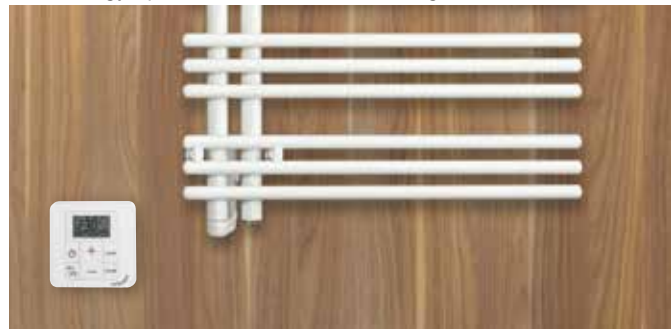

Radiator surface: Chrome, Traffic White

Operation on hot water central heating system

Zehnder Yucca Asym decorative radiator made from horizontally arranged precision steel tubes and vertical header tubes, without visible welds and fully welded due to capstan welding technology.

Sets of 3 horizontal tubes each branch asymmetrically from the laterally arranged manifolds. Towels can be slid in from the side to warm or dry. Single or double-layer version. Header tubes Ø 30 mm, horizontal tubes Ø 20 mm.

Thermal outputs to EN 442, with CE marking.

4 x 1/2" connection at the ends of the header tubes for flow, return, electric heating element and venting. Connection size 50 mm for using a connection fitting in single or twin-tube operation.

Radiator with powder coating, in colour RAL 9016 as standard, in special colour or chrome on request. Delivered ready to install with matching wall brackets in colour of radiator.

Operating pressure	max. 12,0 bar
Operating temperature	max. 110°C
Height mm
Length mm
Model

Benefits

- Small depth
- Easy to clean (lambswool cleaning brush)
- Ideal for hanging up towels
- Can be used as a room divider
- Transparent look
- Connection from top possible
- Dual energy operation with connection fitting possible
- Right-hand or left-hand installation possible

Electric operation

Zehnder Yucca Asym decorative radiator, electric-only, made from horizontally arranged precision steel tubes and vertical header tubes, sets of 3 horizontal tubes each branch asymmetrically from the laterally arranged manifolds. With integrated electric heating element RACY-C in left hand header tube at bottom. Degree of protection IP44 (splash-proof), for mains supply of 230 V. Connection cable (1,2 m) with Euro plug. Decorative radiator filled with heat transfer fluid. Separate, battery-operated remote control device model 2 for controlling the room temperature.

Radiator with powder coating, in colour RAL 9016 as standard, in special colour or chrome on request. Delivered ready to install with matching wall brackets in colour of radiator.

Output Watt
Height mm
Length mm
Model

Special benefits for electric operation with RACY-C

- Remote control device can be positioned as required
- Regulated room temperature
- Comfortable operation as needed by customisable daily and weekly programmes
- Energy-efficient and comfortable heating via innovative open window detection
- Low energy consumption in stand-by mode (≤ 0,5 W)
- Keylock can be activated as required
- Timer function for up to 2 hours
- Ready-to-plug

Zehnder Yucca Asym

Overview of models

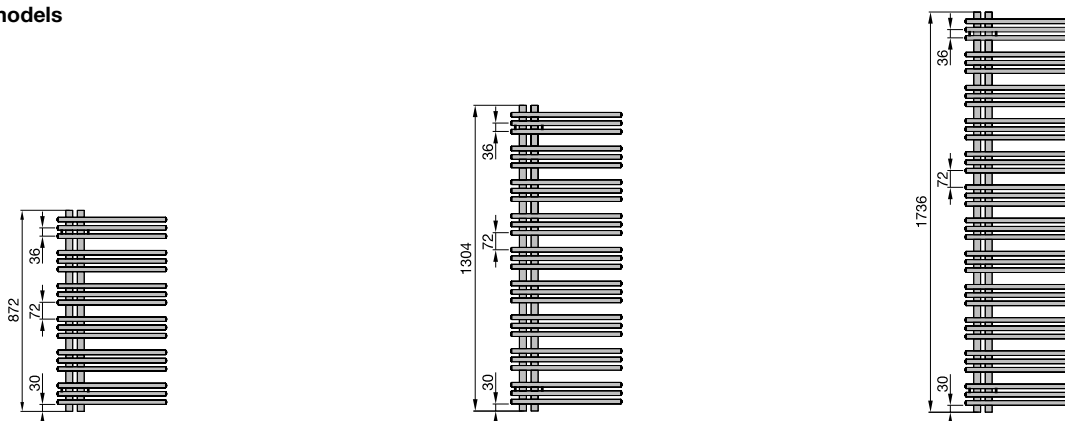

Connection to hot water central heating system or for dual energy operation

Painted version

Model	H mm	L mm	Thermal output				Exp. n	Classification Electric heating element Watt	V dm ³	M kg	Price RAL 9016 €	Price ^① Cat. 1 €
			EN 442 ^③ W	70/55/24 W	55/45/24 W	55/45/20 W						
Single-layer version												
YA-130-040	1304	378	430	305	185	223	1,27	300	3,6	11,1	1.018,40	1.273,00
YA-170-040	1736	378	571	405	246	296	1,27	300	4,8	14,8	1.191,06	1.488,82
YA-090-050	872	478	351	250	152	183	1,26	300	2,8	9,2	872,62	1.090,77
YA-130-050	1304	478	517	367	223	268	1,27	300	4,2	13,3	1.059,19	1.323,99
YA-170-050	1736	478	686	486	296	356	1,27	600	5,6	17,9	1.238,85	1.548,58
YA-130-060	1304	578	599	425	258	311	1,27	600	4,7	15,8	1.100,06	1.375,07
YA-170-060	1736	578	795	564	342	412	1,27	600	6,3	21,1	1.286,69	1.608,36
Double-layer version												
YAD-130-040	1304	378	628	443	267	322	1,29	600	5,7	19,4	1.283,17	1.603,97
YAD-170-040	1736	378	825	580	348	421	1,30	600	7,7	25,9	1.501,34	1.876,67
YAD-090-050	872	478	529	374	226	273	1,28	300	4,6	16,0	1.098,89	1.373,62
YAD-130-050	1304	478	763	538	324	392	1,29	600	6,9	23,9	1.334,56	1.668,21
YAD-170-050	1736	478	1002	705	423	512	1,30	900	9,1	32,0	1.562,04	1.952,55
YAD-130-060	1304	578	893	630	380	458	1,29	600	8,0	28,7	1.385,83	1.732,31
YAD-170-060	1736	578	1173	825	495	599	1,30	900	10,6	38,9	1.647,17	2.058,95

Chrome-plated version

Model	H mm	L mm	Thermal output				Exp. n	Classification Electric heating element Watt	V dm ³	M kg	Price Chrome €
			EN 442 ^③ W	70/55/24 W	55/45/24 W	55/45/20 W					
Single-layer version											
YAC-130-040	1304	378	308	217	130	157	1,30	300	3,6	11,1	2.051,32
YAC-170-040	1736	378	408	286	171	207	1,31	300	4,8	14,8	2.225,31
YAC-090-050	872	478	254	179	108	130	1,29	300	2,8	9,2	1.903,29
YAC-130-050	1304	478	371	261	157	189	1,30	300	4,2	13,3	2.093,47
YAC-170-050	1736	478	492	345	206	250	1,31	300	5,6	17,9	2.274,43
YAC-130-060	1304	578	432	304	182	221	1,30	300	4,7	15,8	2.134,30
YAC-170-060	1736	578	572	401	240	291	1,31	600	6,3	21,1	2.322,04

① For special colours in categories 1 and 2, see "Special solutions" and "Colour chart"

③ Thermal output to EN 442, ΔT 50 K (75/65/20°C)

Zehnder Yucca Asym



Electric-only operation



Painted version

Model	H ^③ mm	L mm	Classification Electric heating element Watt	Price RAL 9016 €	Price ^① Cat. 1 €
-------	----------------------	---------	--	------------------------	-----------------------------------

Single-layer version, right-hand

YAER-130-40/GD	1329	378	500	1.846,17	2.123,10
YAER-090-50/GD	897	478	300	1.705,87	1.961,75
YAER-130-50/GD	1329	478	500	1.879,85	2.161,82
YAER-130-60/GD	1329	578	500	1.925,82	2.214,68
YAER-170-60/GD	1761	578	750	2.271,46	2.612,18

Single-layer version, left-hand

YAEL-130-40/GD	1329	378	500	1.846,17	2.123,10
YAEL-090-50/GD	897	478	300	1.705,87	1.961,75
YAEL-130-50/GD	1329	478	500	1.879,85	2.161,82
YAEL-130-60/GD	1329	578	500	1.925,82	2.214,68
YAEL-170-60/GD	1761	578	750	2.271,46	2.612,18

Chrome-plated version

Model	H ^③ mm	L mm	Classification Electric heating element Watt	Price Chrome €
-------	----------------------	---------	--	----------------------

Single-layer version, right-hand

YAECR-130-40/GD	1329	378	300	2.839,82
YAECR-090-50/GD	897	478	300	2.697,44
YAECR-130-50/GD	1329	478	300	2.874,82
YAECR-130-60/GD	1329	578	300	2.920,82
YAECR-170-60/GD	1761	578	500	3.267,51

Single-layer version, left-hand

YAECL-130-40/GD	1329	378	300	2.839,82
YAECL-090-50/GD	897	478	300	2.697,44
YAECL-130-50/GD	1329	478	300	2.874,82
YAECL-130-60/GD	1329	578	300	2.920,82
YAECL-170-60/GD	1761	578	500	3.267,51

Standard scope of delivery for operation on hot water central heating system

- Powder coating to DIN 55900, RAL 9016
- 4 x ½" connections for flow, return, venting
- 2 x ½" directional air vent
- Mounting accessories in colour of radiator
- Packaging

Standard scope of delivery for electric operation

- Powder coating to DIN 55900, RAL 9016
- Filled with non-flammable heat-transfer fluid (frost-proof to -10°C)
- With integrated electric heating element RACY-C, with remote control device, incl. battery, with selectable operating modes: manual (above room temperature), weekly programme, timer, off
- Electric heating element cover in colour of radiator
- Mounting accessories in colour of radiator
- Packaging

① For special colours in categories 1 and 2, see "Special solutions" and "Colour chart"

③ Total height incl. electric heating element

For legend, see "Electric operation and Ecodesign Directive" on page 173  

Zehnder Yucca Asym

Special solution on request (surcharge)	Article number	Price €
■ Special finish to category 2 (surcharge on cat. 1)	6500011640	146,76
■ Galvanized and painted	-	On request
■ Heating element WIVAR II for dual energy operation	-	See page 161
■ Accessories	-	See page 160
■ Lambswool cleaning brush	601040	60,41
■ Connection fitting with short cover (operation on central heating system only), cover in white	976021	172,59
■ Connection fitting with short cover (operation on central heating system only), cover in special finish	976029	184,97
■ Connection fitting with short cover (operation on central heating system only), cover in chrome	976028	229,18
■ Connection fitting with long cover (for dual energy operation with WIVAR II), cover in white	976031	172,59
■ Connection fitting with long cover (for dual energy operation with WIVAR II), cover in special finish, incl. cover parts set	976039	233,28
■ Connection fitting with long cover (for dual energy operation with WIVAR II), cover in chrome, incl. cover parts set	976038	289,54
■ Zehnder thermostat DH, M 30 x 1,5, white	819050	35,02
■ Zehnder thermostat DH, M 30 x 1,5, chrome	819058	53,36
■ Zehnder valves and lockshield valves	-	See p. 165 onwards

Operation on hot water central heating system: Right-hand version ¹⁾ Single-layer

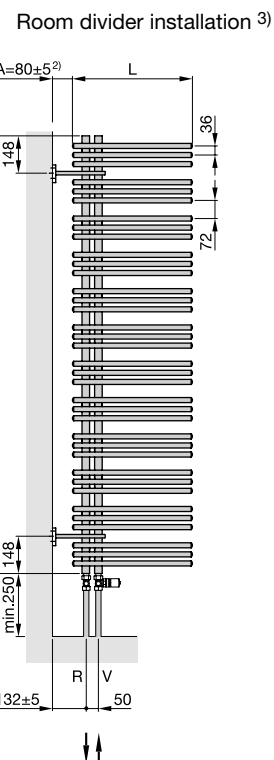
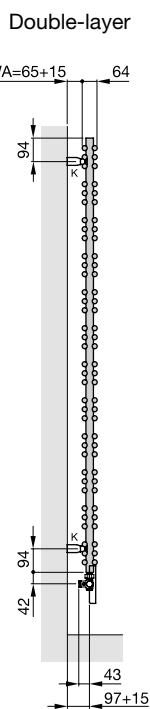
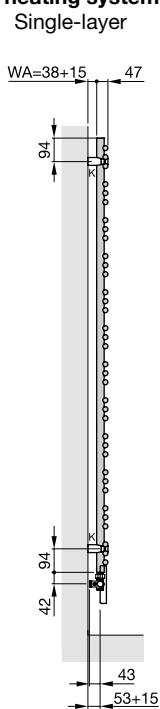
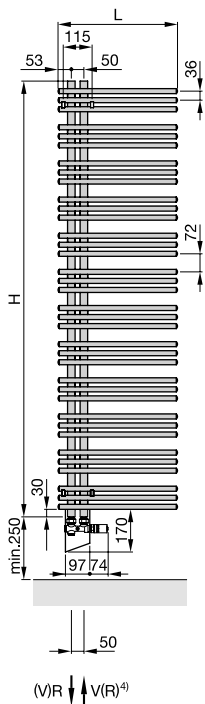

Electric operation: Single-layer

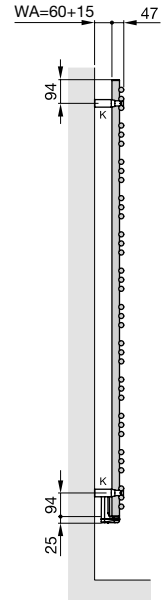

Dual energy operation: Detailed view Right-hand version

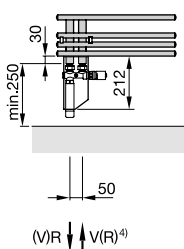

Detail: Connection fitting with long cover and integrated electric heating element WIVAR II.

Electric operation: Detailed view Right-hand version

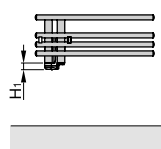

Electric operation: Detailed view Left-hand version

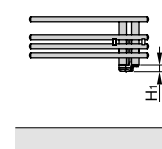

Details with integrated heating element RACY-C.

- H = Height
 - H₁ = 25 mm
 - L = Length
 - K = Bracket
 - WA = Wall clearance
 - V = Flow
 - R = Return
- Dimensions in mm

1) Models for operation on hot water central heating systems can be installed as right-hand version or left-hand version
 2) Brackets with modified wall clearance on request
 3) Dual energy operation with room divider installation possible only when T-piece is used (see "Accessories")
 4) Flow is possible on both sides of the connection fitting

For legend, see "Electric operation and Ecodesign Directive" on page 173

Zehnder Vitalo Bar



Radiator colour: Cream



Zehnder EasyFit - with integrated valve incl. thermostat

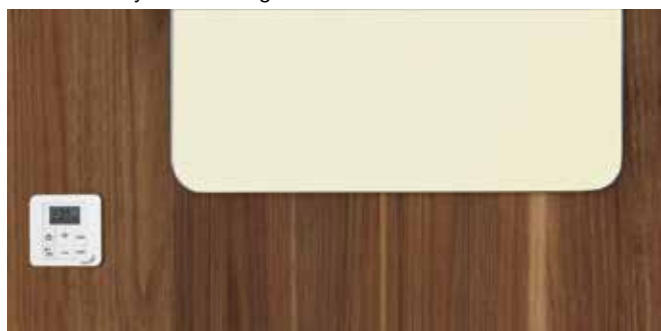

Operation on hot water central heating system

Zehnder Vitalo Bar decorative radiator with smooth aluminium front and back plus copper tube heating register in graphite/aluminium construction.

Surrounding, sealed frame of black polyamide. Includes one or two chrome towel rails, depending on the model. Thermal output to EN 442, with CE marking. With two 1/2" female thread connections for flow and return, positioned at bottom centre, spacing 50 mm.

Completo version with concealed Zehnder EasyFit connection box with flow/return 2 x 3/4" external thread at the back, centred 50 mm clearance, including pre-adjustable valve AV 9 and adjustment dial and folding mechanism for installation.

Radiator with powder coating, in colour RAL 9016 as standard, or in special colour or with an anodised aluminium surface on request, delivered ready to install with wall brackets and packaging.

Electric operation

Zehnder Vitalo Bar decorative radiator with smooth aluminium front and back plus heating cable in graphite/aluminium construction. Surrounding, sealed frame of black polyamide. Includes one or two chrome towel rails, depending on the model.

With CE marking. Separate battery-operated remote control device model 2, control box RACY-S and no visible control elements on the radiator. Splash-proof for mains power supply of 230 V. Connection cable (1,2 m) with Schuko plug.

Radiator with powder coating, in colour RAL 9016 as standard, or in special colour or with an anodised aluminium surface on request, Delivered ready to install with wall brackets and packaging.

Operating pressure	max. 10 bar
Operating pressure Zehnder EasyFit	max. 6 bar
Operating temperature	max. 80°C
Height mm
Length mm
Model

Output Watt
Height mm
Length mm
Model

Benefits

- Innovative technology for efficient heating
- Extremely slim and noticeably light
- High proportion of radiation
- A striking profile for a distinctive look
- Simple accommodation of textiles with towel rail accessible from one side
- Hygienic and simple to clean
- Supports integrated connection due to Zehnder EasyFit

Special benefits for electric operation with RACY-S

- Fast thermal radiation
- Remote control device can be positioned as required
- Regulated room temperature
- Comfortable operation as needed by customisable daily and weekly programmes
- Energy-efficient and comfortable heating via innovative open window detection
- Low energy consumption in stand-by mode (≤ 0,5 W)
- Keylock can be activated as required
- Timer function for up to 2 hours
- Ready-to-plug

Zehnder Vitalo Bar

Overview of models

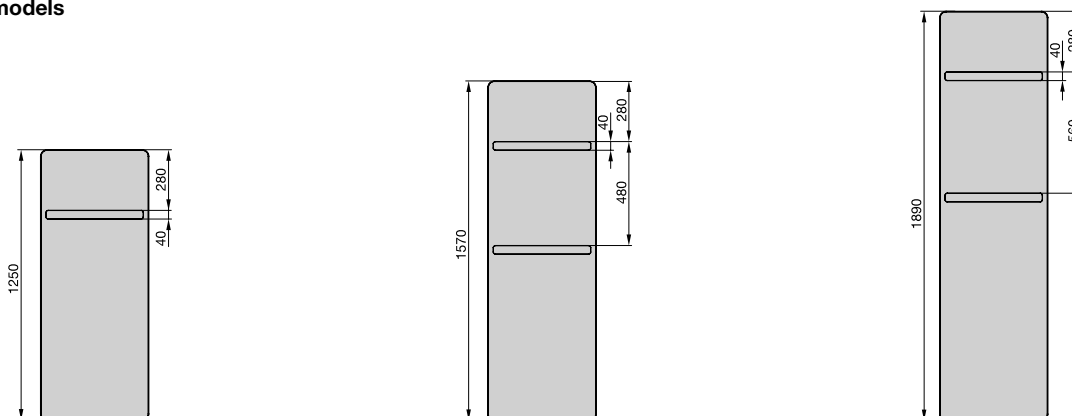

Connection to hot water central heating system, 50 mm centre connections

Painted version with towel rail in chrome

Model	H	L	Thermal output				Exp.	Electric output Watt	V	M	Price RAL 9016 €	Price ^① Cat. 1 €
			EN 442 ^③ Watt	70/55/24 Watt	55/45/24 Watt	55/45/20 W						
VIP-125-040	1250	400	465	334	207	248	1,22	-	0,7	7,0	1.421,14	1.776,43
VIP-160-040	1570	400	546	394	246	294	1,20	-	0,7	9,3	1.676,40	2.095,50
VIP-190-040	1890	400	673	485	302	360	1,21	-	0,9	10,9	1.876,49	2.345,61
VIP-125-050	1250	500	555	399	247	295	1,22	-	0,8	8,7	1.449,52	1.811,91
VIP-160-050	1570	500	676	487	303	362	1,21	-	0,9	11,4	1.711,07	2.138,84
VIP-190-050	1890	500	834	601	374	446	1,21	-	1,1	12,7	1.914,30	2.392,88
VIP-125-060	1250	600	641	462	287	343	1,21	-	0,9	10,5	1.495,23	1.869,03
VIP-160-060	1570	600	806	577	359	429	1,21	-	1,0	13,6	1.766,20	2.207,76
VIP-190-060	1890	600	994	716	446	532	1,21	-	1,3	14,6	1.974,19	2.467,73

Connection to hot water central heating system, Zehnder EasyFit connection box

Painted version with towel rail in chrome

Model	H ^④	L	Thermal output				Exp.	Electric output Watt	V	M	Price RAL 9016 €	Price ^① Cat. 1 €
			EN 442 ^③ Watt	70/55/24 Watt	55/45/24 Watt	55/45/20 W						
VIPK-125-040	1275	400	465	334	207	248	1,22	-	0,7	9,5	1.783,53	2.229,41
VIPK-160-040	1595	400	546	394	246	294	1,20	-	0,7	11,8	2.038,78	2.548,48
VIPK-190-040	1915	400	673	485	302	360	1,21	-	0,9	13,4	2.238,86	2.798,58
VIPK-125-050	1275	500	555	399	247	295	1,22	-	0,8	11,2	1.811,90	2.264,87
VIPK-160-050	1595	500	676	487	303	362	1,21	-	0,9	13,9	2.073,46	2.591,82
VIPK-190-050	1915	500	834	601	374	446	1,21	-	1,1	15,2	2.276,70	2.845,87
VIPK-125-060	1275	600	641	462	287	343	1,21	-	0,9	13,0	1.857,60	2.321,99
VIPK-160-060	1595	600	806	581	361	431	1,21	-	1,0	16,1	2.128,58	2.660,72
VIPK-190-060	1915	600	994	716	446	532	1,21	-	1,3	17,1	2.336,57	2.920,71

① For special colours in categories 1 and 2, see “Special solutions” and “Colour chart”

③ Thermal output to EN 442, ΔT 50 K (75/65/20°C)

④ Total height incl. Zehnder EasyFit connection box

Zehnder Vitalo Bar



Electric-only operation



Painted version with towel rail in chrome

Model	H	L	Electric output Watt	Price	Price ^①
	mm	mm		RAL 9016 €	Cat. 1 €
VIPE-125-040/GD	1250	400	350	1.833,95	2.109,04
VIPE-160-040/GD	1570	400	500	2.164,82	2.489,54
VIPE-190-040/GD	1890	400	500	2.421,64	2.784,89
VIPE-160-050/GD	1570	500	500	2.208,92	2.540,27
VIPE-190-050/GD	1890	500	750	2.472,06	2.842,87
VIPE-190-060/GD	1890	600	1000	2.547,70	2.929,85

Anodised aluminium version, with towel rail in chrome

Model	H	L	Electric output Watt	Price
	mm	mm		Alu. anod. €
VIPES-160-40/GD	1570	400	350	2.489,54
VIPES-190-40/GD	1890	400	500	2.784,89
VIPES-190-50/GD	1890	500	500	2.842,87
VIPES-190-60/GD	1890	600	750	2.929,85

Standard scope of delivery for operation on hot water central heating system

- Powder coating to DIN 55900, RAL 9016
- 2 x ½" connections for flow/return, central, 50 mm
- 2 x double nipple ¾" external thread x ½" external thread for joining to fitting
- EasyFit: Connection box in colour of radiator; connection fitting 2 x ¾" Eurocone to back with 50 mm incl. shut-off for dual-pipe system, thermostat valve with remote control and adjustment dial beneath the radiator; flexible connection
- ½" decorative chrome directional air vent
- Towel rail in chrome (1 x for 1250 mm height, 2 x for 1570 mm and 1890 mm height), fixing point on right
- Mounting accessories in colour of radiator
- Packaging

Standard scope of delivery for electric operation

- Powder coating to DIN 55900, RAL 9016
- Remote control device, incl. batteries, with selectable operating modes: manual (above room temperature), weekly programme, timer, off
- Towel rail in chrome (1 x for 1250 mm height, 2 x for 1570 mm and 1890 mm height)
- Mounting accessories in colour of radiator
- Packaging

Special solution on request (surcharge)	Article number	Price €
■ Special finish to category 2 (surcharge on cat. 1)	A700011640	146,76
■ Highly-polished metal surfaces: anodised aluminium	-	As in Cat. 1
■ Surface in metal look: stainless steel look	-	As in Cat. 1
■ Integrated valve incl. thermostat; note Zehnder EasyFit table	-	See table
■ Radiator with towel rail, fixing point on left (surcharge on standard version)	-	97,20
■ Zehnder valves, lockshield valves and connection fittings	-	See p. 165 onwards

① For special colours in categories 1 and 2, see "Special solutions" and "Colour chart"

For legend, see "Electric operation and Ecodesign Directive" on page 173

Zehnder Vitalo Bar

Operation on hot water central heating system:
Wall mounting

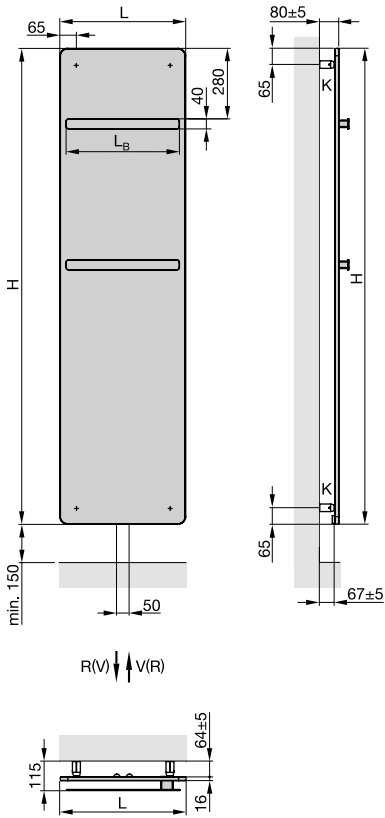

Operation on hot water central heating system with Zehnder EasyFit connection box¹⁾:

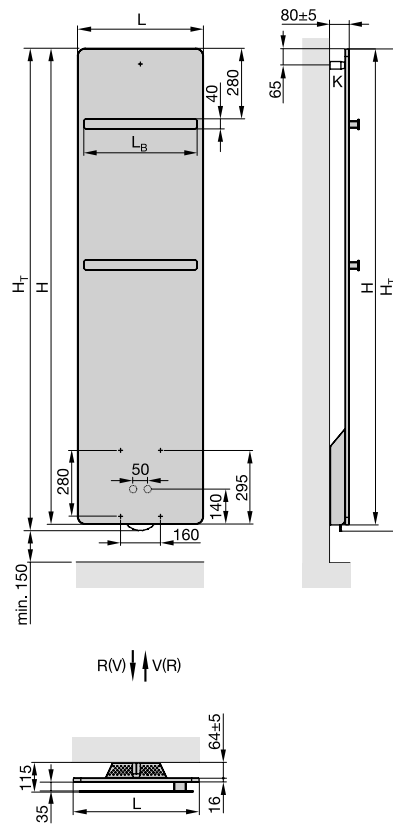

Electric operation:

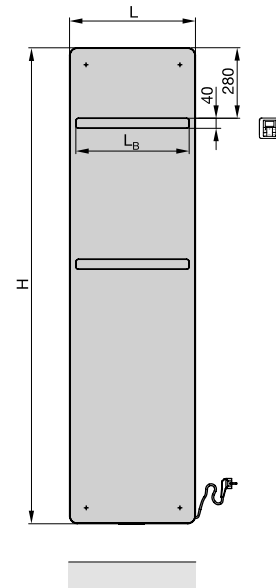

Accessory EasyFit connection box

- H = Height
- H_T = Total height, H + 25 mm
- L = Length
- L_B = Length of towel rail, L - 50 mm²⁾
- V = Flow
- R = Return
- K = Bracket

Dimensions in mm

- 1) Without internal by-pass for single-tube operation
- 2) Towel rail 1 x for H = 1250 mm, 2 x for H = 1570 mm and 1890 mm

Zehnder Fain



Radiator colour: Chrome-plated



Operation on hot water central heating system

The Zehnder Fain gets its lightweight appearance from the narrow heating tubes of just 12 mm, which run into the equally delicate 18 mm manifolds at the sides. Since the valves face inwards, these form part of the continuous vertical outer edge. Two recesses for bath towels make the Zehnder Fain perfectly suited to use in the bathroom.

Zehnder Fain can be connected to the central heating system or is also suitable for electric only operation. Radiator with powder coating, in the colour RAL 9016 as standard, in a special colour or in chrome on request.

Thermal output tested to EN 442, with CE marking. Standard 2 x 1/2" connections with female thread, flow/return on left or right bottom, horizontal facing inwards and 1/4" air vent.

Delivered ready to install with matching wall brackets and assembly kit in packaging.

Operating pressure	max. 10 bar
Operating temperature	max. 110°C
Height mm
Length mm
Model

Benefits

- Lightweight, modern design that adds an elegant touch to the bathroom
- Inwards facing valves, forming continuous vertical outer edge
- Also available as room divider
- Two recesses, ideal for hanging towels

Electric-only operation

Zehnder Fain sets a modern and stylish accent in the room, combining unmistakable design and high functionality. Space-saving design - for up to 4 towels, which can be warmed at the same time. Round tubes Ø 25 mm made of steel. With built-in heating element, Protection class IP44 (splash-proof), for mains connection 230 volts.

With connecting cable 1,2 m long with contour plug. Cable, plug and cable cap white, for chrome-plated radiators cable and plug grey, cap chrome. Design radiator filled with heat transfer fluid. The heating element has no operating option.

The control must be planned and executed on site.

Zehnder Fain

Overview of models

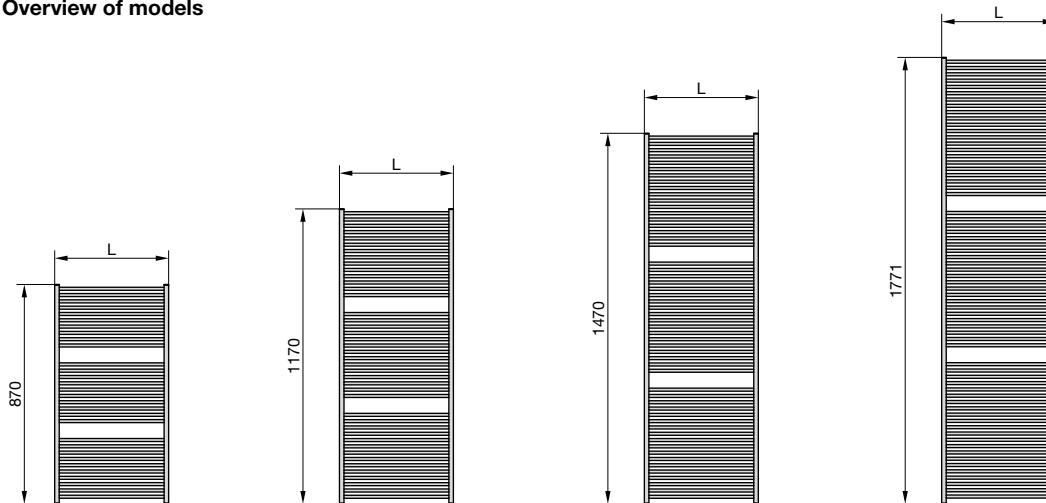

Connection to hot water central heating system

Painted version

Model	H mm	L mm	Thermal output				Exp. n	Electric output Watt	V dm ³	M kg	Price RAL 9016 €	Price ^① Cat. 1 €
			EN 442 ^③ Watt	70/55/24 Watt	55/45/24 Watt	55/45/20 W						
FZA-090-045	900	450	393	282	174	208	1,23	-	1,7	6,8	557,52	696,90
FZA-090-055	900	550	468	335	207	248	1,23	-	1,9	7,9	636,51	795,64
FZA-120-055	1200	550	637	455	280	336	1,24	-	2,7	10,8	732,67	915,84
FZA-120-065	1200	650	736	526	323	388	1,24	-	2,9	12,4	801,36	1.001,70
FZA-150-055	1500	550	809	577	353	424	1,25	-	3,4	13,8	835,70	1.044,63
FZA-150-065	1500	650	936	667	409	491	1,25	-	3,7	15,7	904,39	1.130,49
FZA-180-055	1800	550	986	703	430	517	1,25	-	4,1	16,7	973,08	1.216,35
FZA-180-065	1800	650	1104	787	482	579	1,25	-	4,5	19,1	1.064,66	1.330,83

Chromed version

Model	H mm	L mm	Thermal output				Exp. n	Electric output Watt	V dm ³	M kg	Price Chrome €
			EN 442 ^③ Watt	70/55/24 Watt	55/45/24 Watt	55/45/20 W					
FZAC-090-045	900	450	267	190	117	140	1,25	-	1,7	6,6	1.110,46
FZAC-090-055	900	550	319	227	139	167	1,25	-	1,9	7,7	1.190,59
FZAC-120-055	1200	550	435	309	189	227	1,26	-	2,7	10,6	1.453,90
FZAC-150-055	1500	550	556	394	240	288	1,27	-	3,4	13,4	1.694,30
FZAC-180-055	1800	550	684	482	291	351	1,29	-	4,1	16,4	2.014,85

Zehnder Fain



Electric-only operation

Painted version



Model	H mm	L mm	Electric output Watt	Price RAL 9016 €	Price ^① Cat. 1 €
FZA-120-055/AD	1170	550	350	961,63	1.105,88
FZA-150-055/AD	1470	550	650	1.041,77	1.198,03
FZA-180-055/AD	1770	550	900	1.133,35	1.303,35

Chromed version

Model	H mm	L mm	Electric output Watt	Price Chrome €
FZAC-120-055/AD	1170	550	350	1.625,62
FZAC-150-055/AD	1470	550	650	1.923,26

Standard scope of delivery for operation on hot water central heating system

- Powder coating to DIN 55900, RAL 9016
- Standard 2 × ½" with internal thread, flow /return on left or right, bottom, horizontal facing inwards
- ¼" decorative chrome directional air vent
- Mounting accessories in colour of radiator
- Packaging

Standard scope of delivery for electric operation

- Powder coating to DIN 55900, RAL 9016
- With built-in heating element, protection class IP44 (splash-proof), for mains connection 230 volts. The heating element does not have any control option. The control is to be planned on site
- Connection cable 1.2 m long with Euro plug. Cable, plug and cable cap in white; for chrome-plated radiators, cable and plug in gray, cap in chrome.
- Mounting accessories in colour of radiator
- Packaging
- Fast thermal radiation

Special solution on request (surcharge)	Article number	Price €
■ Special finish to category 2 (surcharge on cat. 1)	6500011640	146,76
■ Electric heating element for dual energy operation	-	see p. 161
■ Accessories	-	see p. 160
■ Zehnder valves, lockshield valves and connection fittings	-	See p. 165 onwards

① For special colours in categories 1 and 2, see "Special solutions" and "Colour chart"

For legend, see "Electric operation and Ecodesign Directive" on page 173

Zehnder Fain

Operation on hot water central heating system:
Wall mounting

Electric operation:

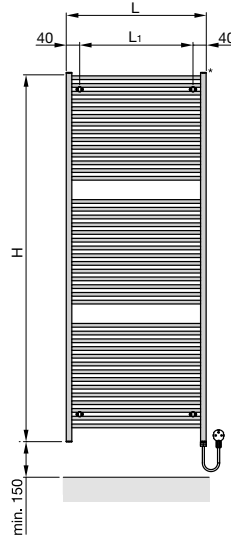
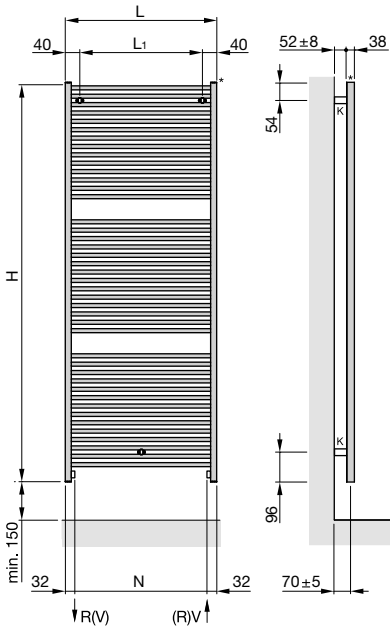

- H = Height
- H_T = Total height, H + 25 mm
- L = Length
- L_B = Length of towel rail, L - 50 mm²⁾
- V = Flow
- R = Return
- K = Bracket

Dimensions in mm

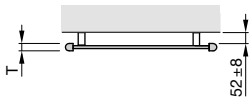

Electric heating Element RE

Characteristics:

- Mains voltage: 230 V, 50 Hz +/- 10 %
- Nominal rating: 350, 650, 900 Watt
- Mains connection: 1,2 m power cable with plug
- Degree of protection: Class I (IP65)

Functions:

- Thermal limitation integrated
- Once the electric heating element is in operation it switches on/off as per reached temperature of the towel radiator



Electric only version FZA / FZAC

Zehnder Roda Twist Spa Air



Radiator colour: Reseda Green

Electric operation

Zehnder Roda Twist Spa Air decorative radiator for electric-only operation; made from horizontally arranged precision flat tubes and vertical header tubes, without visible welds, fully welded.

Single-sided, asymmetrically arranged flat tubes 70 x 11 mm branching laterally from the manifold Ø 38 mm; radiator can be pivoted 180° from the wall; towels can be slid in from the side to warm or dry.

Dual electrical heating system, comprising electric heating element integrated into the outer manifold and concealed boost heater arranged behind the radiator with flow direction downwards and forwards.

Common mains power supply of 230 V for electric heating element and boost heater, connection cable 1,2 m with Euro plug; splash-proof, IP24, with CE marking; separate battery-operated infrared control device model 3 for controlling the electric heating element and for controlling the boost heater with different operating modes; decorative radiator filled with heat transfer fluid.

Radiator with powder coating, in colour RAL 9016 as standard, in special colour on request. Delivered ready to install with wall brackets incl. cover in colour of radiator.

Output Watt
Height mm
Length mm
Model

Benefits

- Practical access to the hand towel from the side
- Pivotable by 180°
- Separate or mixed operation of electric heating element and boost heater possible
- Boost function for rapid heating
- Radiant heat and reheating time
- Daily programme, weekly programme can be activated as an option (Eco and Comfort mode)
- Extra hygiene through cleanable air filter
- Energy-efficient and comfortable heating via innovative open window detection
- Low energy consumption in stand-by mode ($\leq 0,5$ W)
- Ready-to-plug

Standard scope of delivery for electric operation

- Powder coating to DIN 55900, RAL 9016
- Electric heating element with selectable operating modes: manual (above room temperature) daily programme, off, weekly programme can be activated as an option (Eco and Comfort mode)
- Electric boost heater with timer function, incl. over-heat protection
- Infrared control device model 3 incl. batteries
- Radiator filled with heat transfer fluid
- Mounting accessories for wall mounting with pivot function
- Packaging

Zehnder Roda Twist Spa Air

Electric-only operation



Painted version

Model	H ^② mm	L mm	Output Boost heater Watt	Classification Electric heating element Watt	Price	Price ^①
					RAL 9016 €	Cat. 1 €
Right-hand version						
ROER-100-55/IPS	966	550	1000	500	1.467,67	1.687,82
ROER-140-55/IPS	1344	550	1000	750	1.595,65	1.834,99
ROER-190-55/IPS	1837	550	1000	1000	1.882,36	2.164,71
Left-hand version						
ROEL-100-55/IPS	966	550	1000	500	1.467,67	1.687,82
ROEL-140-55/IPS	1344	550	1000	750	1.595,65	1.834,99
ROEL-190-55/IPS	1837	550	1000	1000	1.882,36	2.164,71

Special solution on request (surcharge)	Article number	Price €
■ Special finish to category 2 (surcharge on cat. 1)	R200011640	146,76
■ Towel rail, magnetic, overall length 399 mm	471108	269,02
■ Towel hook, magnetic	470328	135,31

Electric operation: Left-hand version

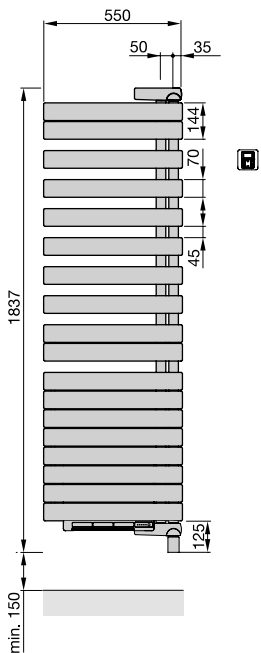

Right-hand version

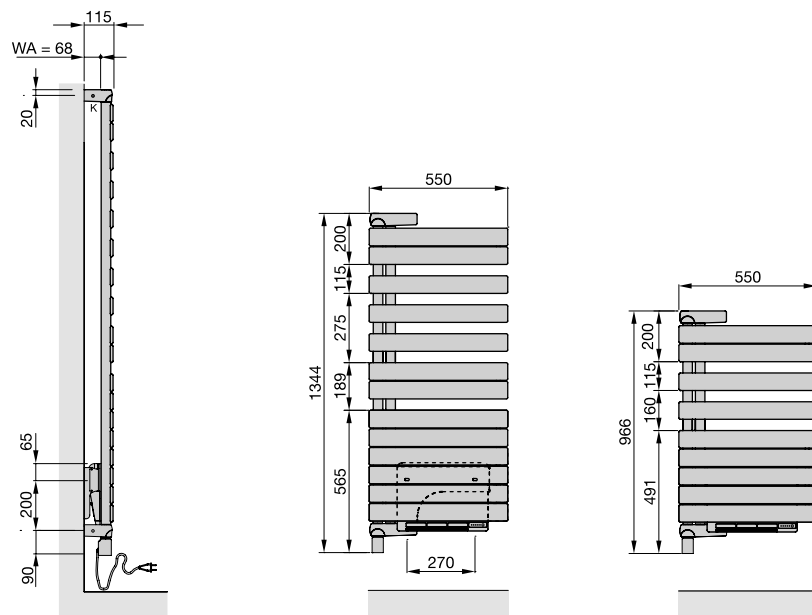

WA = Wall clearance
K = Bracket

Dimensions in mm

① For special colours in categories 1 and 2, see "Special solutions" and "Colour chart"

② Total height incl. electric heating element and bracket

For legend, see "Electric operation and Ecodesign Directive" on page 173

Zehnder Charleston Bar



Radiator colour: Traffic White



Radiator colour: Traffic White

Operation on hot water central heating system

Zehnder Charleston Bar radiator with towel rail as 2-column or 3-column radiator with vertical precision round tubes and header, fully welded. The individual elements are welded together into finished blocks. Header in sheet steel, round tubes in steel Ø 25 mm. Uses connector technologies with absolutely no melting loss; produced using the LaZer made technique.

Thermal output to EN 442, with CE marking.

The function of the radiator is supplemented by the chrome-plated towel rail for drying and warming towels.

Radiator with powder coating, in colour RAL 9016 as standard, in special colour on request.

Delivered ready to install with holders and wall brackets in colour of radiator. Connections for flow and return in 1/2", central, spacing 50 mm from bottom to bottom. 1/2" venting on the side at the top.

Benefits

- Residue-free laser welding technology LaZer made
- Classic timeless design
- Towel rail with variable mounting options
- High thermal output
- Central connections, 50 mm
- Matching connection fitting available

Operating pressure	max. 10,0 bar
Operating temperature	max. 110°C
Height mm
Length mm
Model

Zehnder Charleston Bar

Connection to hot water central heating system

Zehnder Charleston Bar – painted version with chrome towel rail

Model	H mm	L mm	Thermal output				Exp. n	Classification Electric heating element Watt	V dm ³	M kg	Price RAL 9016 €	Price ^① Cat. 1 €
			EN 442 ^③ W	70/55/24 W	55/45/24 W	55/45/20 W						
2-column version												
CPV 2150-10	1492	485	1038	734	444	536	1,28	-	13,0	21,3	924,43	1.155,54
CPV 2180-10	1792	485	1244	872	522	632	1,31	-	15,0	25,3	1.003,37	1.254,22
CPV 2150-12	1492	577	1246	881	533	643	1,28	-	15,6	25,3	1.011,53	1.264,41
CPV 2180-12	1792	577	1493	1047	626	759	1,31	-	18,0	30,0	1.106,22	1.382,78
CPV 2150-14	1492	669	1453	1027	622	750	1,28	-	18,2	29,5	1.118,49	1.398,12
CPV 2180-14	1792	669	1742	1222	731	885	1,31	-	21,0	35,0	1.229,01	1.536,27
CPV 2150-16	1492	761	1661	1174	711	857	1,28	-	20,8	33,5	1.205,59	1.506,99
CPV 2180-16	1792	761	1991	1396	835	1012	1,31	-	24,0	39,8	1.331,87	1.664,84
3-column version												
CPV 3150-10	1500	485	1402	983	588	712	1,31	-	20,0	31,2	1.111,55	1.389,44
CPV 3180-10	1800	485	1656	1155	686	833	1,33	-	24,0	37,1	1.257,31	1.571,64
CPV 3150-12	1500	577	1683	1180	706	855	1,31	-	24,0	37,2	1.236,06	1.545,07
CPV 3180-12	1800	577	1987	1386	823	999	1,33	-	28,8	44,3	1.411,00	1.763,74
CPV 3150-14	1500	669	1963	1377	824	997	1,31	-	28,0	43,4	1.380,46	1.725,56
CPV 3180-14	1800	669	2318	1617	960	1166	1,33	-	33,6	51,6	1.584,55	1.980,68
CPV 3150-16	1500	761	2243	1573	941	1140	1,31	-	32,0	49,4	1.504,98	1.881,22
CPV 3180-16	1800	761	2650	1848	1097	1333	1,33	-	38,4	58,8	1.738,23	2.172,79

Standard scope of delivery for operation on hot water central heating system

- Powder coating to DIN 55900, RAL 9016
- 2 x ½" central connections 50 mm
- ½" chrome directional air vent
- Mounting accessories in colour of radiator
- Towel rail, length 412 mm for 10 and 12 elements or 596 mm for 14 and 16 elements
- Packaging

Special solution on request (surcharge)	Article number	Price €
■ Special finish to category 2 (surcharge on cat. 1)	5600011640	146,76
■ Accessories	-	See page 160
■ Easy-access design with lateral connections, dimension "N" needed when placing order (see page 74)	-	180,71
■ Mounting: console EasyFix (SMB2T) instead of CVDO	-	No surcharge
■ Zehnder thermostat LH2, M 30 x 1,5, white	819140	35,02
■ Zehnder thermostat LH2, M 30 x 1,5, chrome	819148	60,35
■ Zehnder valves and lockshield valves	-	See p. 165 onwards

① For special colours in categories 1 and 2, see "Special solutions" and "Colour chart"

③ Thermal output to EN 442, ΔT 50 K (75/65/20°C)

Zehnder Charleston Bar



Operation on hot water central heating system:
Zehnder Charleston Bar

Special version "easy-access" with
EasyFix console (SMB2T) connection: 2270 / 6610

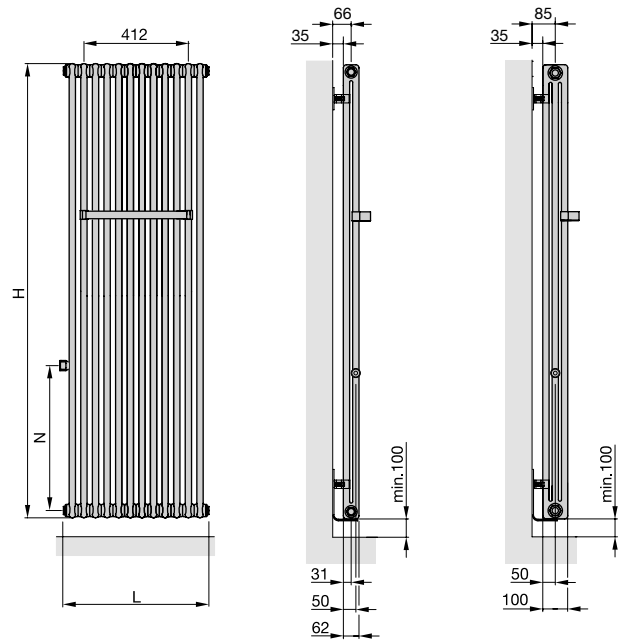
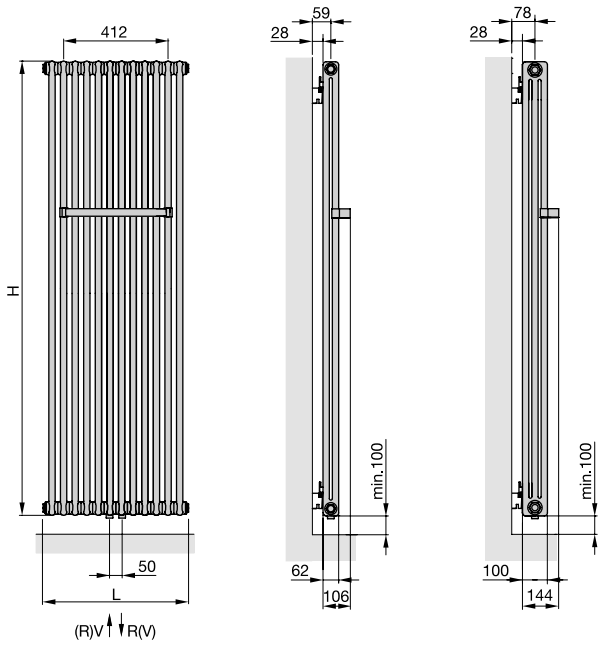

- H = Height
- L = Length incl. plug
- V = Flow
- R = Return
- N = 500, 600, 619, 700, 800, 819, 900
(indicate dimension when ordering)

Dimensions in mm

Zehnder Metropolitan Spa



Radiator colour: Brown Quartz

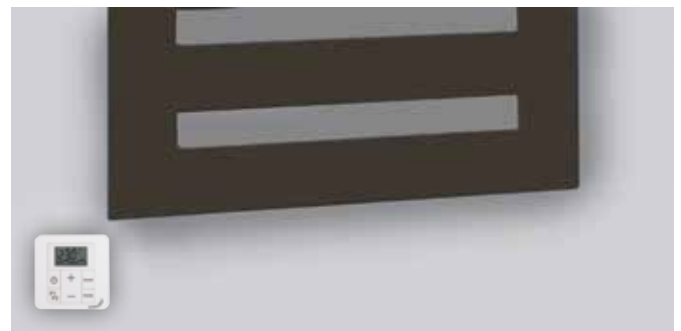
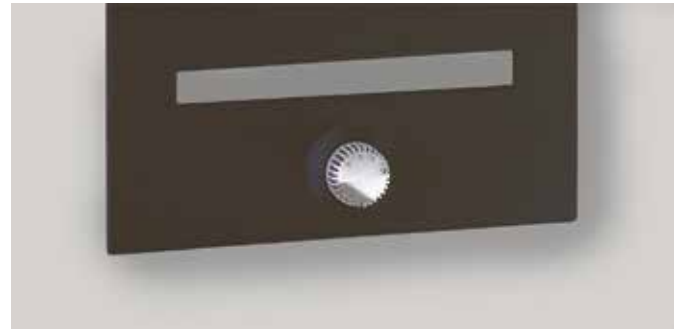

Operation on hot water central heating system

Zehnder Metropolitan Spa decorative radiator for use as a bathroom and towel radiator. Flat-looking radiator with recessed slots, made from horizontally arranged flat tubes 70 x 8 mm, which are connected with a surrounding triangular profile frame without visible welded joints. With one or more openings (depending on height) for hanging towels. Thermal output to EN 442, with CE marking. With 4 connections at bottom, 2 x central 1/2" for flow/return, spacing 50 mm and 2 x 1/2", outside left and right, with directional air vent.

Connections for Completo version: Flow/return 2 x 3/4" external thread at the back, centred 50 mm spacing, including valve and thermostat integrated into front panel.

Connections for dual energy operation: Flow/return 2 x 1/2" at bottom centre, spacing 50 mm and factory covered integrated electric heating element RACY-S, bottom right, with separate remote control device model 2.

Radiator with powder coating, in colour RAL 9016 as standard, in special colour on request. Delivered ready to install with matching wall brackets and packaging.

Electric operation

Zehnder Metropolitan Spa decorative radiator, electric-only, for use as a bathroom and towel radiator. Flat-looking radiator with recessed slots, made from horizontally arranged flat tubes 70 x 8 mm, which are connected with a surrounding triangular profile frame without visible welded joints. With one or more openings (depending on height) for hanging towels.

Electric heating element RACY-S integrated elegantly in the frame profile, with connection cable (1,2m), with Euro plug. Installation at bottom right. Dry-running protection against operation without sufficient heat transfer fluid, degree of protection IP44 (splash-proof), for mains power supply of 230 V. Separate, battery-operated remote control device model 2 for controlling the room temperature.

Standard version with powder coating, in colour RAL 9016, in special colour on request. Filled with heat transfer fluid. Delivered ready to install with elegant wall brackets.

Operating pressure	max. 4,0 bar
Hot water central heating system operating temperature	max. 110°C
Dual energy operation operating temperature (model METM)	max. 95°C
Height mm
Length mm
Model

Output Watt
Height mm
Length mm
Model

Benefits

- Innovative radiator with flat design
- Clean look due to innovative welding technology
- Ideal towel hanging through large cut-out(s)
- Individually positionable designer towel hook
- Elegant solutions for valve integration on request
- Dual energy operation: electric heating element RACY-S integrated elegantly
- Side connections for easy replacement of old DIN standard radiators on request

Special benefits for electric operation with RACY-S

- Remote control device can be positioned as required
- Regulated room temperature
- Comfortable operation as needed by customisable daily and weekly programmes
- Energy-efficient and comfortable heating via innovative open window detection
- Low energy consumption in stand-by mode ($\leq 0,5$ W)
- Keylock can be activated as required
- Timer function for up to 2 hours
- Ready-to-plug

Zehnder Metropolitan Spa



Overview of models

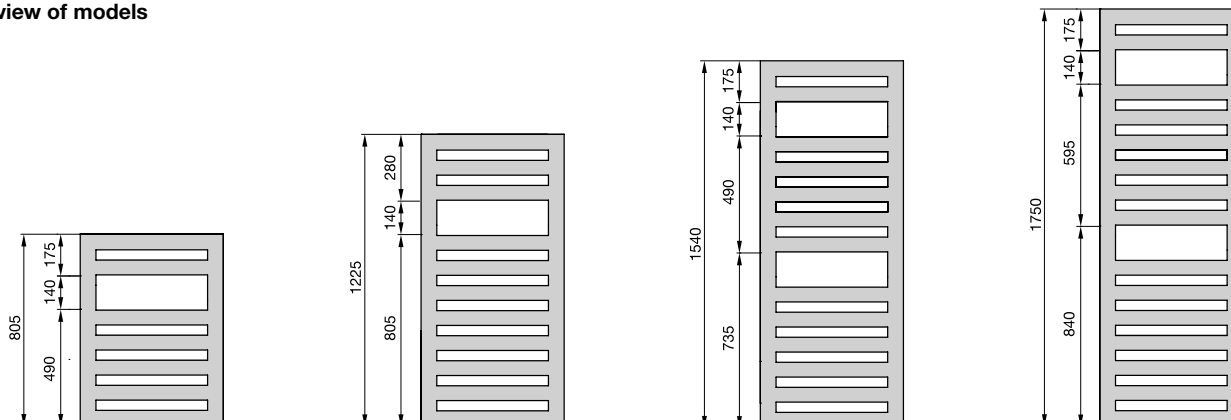

Connection to hot water central heating system

Painted version

Model	H ^① mm	L mm	Thermal output				Exp. n	Classification Electric heating element Watt	V dm ³	M kg	Price RAL 9016 €	Price ^① Cat. 1 €
			EN 442 ^③ W	70/55/24 W	55/45/24 W	55/45/20 W						
MET-080-040	805	400	327	233	143	171	1,25	-	3,5	6,5	708,23	885,28
MET-120-040	1225	400	474	337	206	247	1,26	-	4,8	9,8	785,05	981,32
MET-150-040	1540	400	582	414	252	303	1,26	-	5,4	11,5	928,37	1.160,46
MET-180-040	1750	400	654	466	285	343	1,25	-	6,5	13,7	1.037,60	1.297,01
MET-080-050	805	500	388	276	168	202	1,26	-	3,8	7,8	721,90	902,38
MET-120-050	1225	500	561	399	243	293	1,26	-	5,2	11,7	802,11	1.002,65
MET-150-050	1540	500	690	489	297	358	1,27	-	5,9	13,5	947,15	1.183,95
MET-180-050	1750	500	775	551	336	404	1,26	-	7,3	16,3	1.059,80	1.324,76
MET-080-060	805	600	445	315	192	231	1,27	-	4,2	9,1	745,81	932,26
MET-120-060	1225	600	645	457	278	335	1,27	-	5,7	13,5	827,70	1.034,62
MET-150-060	1540	600	792	560	339	409	1,28	-	6,5	15,6	976,16	1.220,20
MET-180-060	1750	600	889	630	383	461	1,27	-	8,0	19,0	1.092,23	1.365,29

Connection for dual energy operation with integrated electric heating element¹⁾



Painted version

Model	H mm	L mm	Thermal output				Exp. n	Classification Electric heating element Watt	V dm ³	M kg	Price RAL 9016 €	Price ^① Cat. 1 €
			EN 442 ^③ W	70/55/24 W	55/45/24 W	55/45/20 W						
METM-120-050/GD	1225	500	561	399	243	293	1,26	500	5,1	12,2	1.305,76	1.501,63
METM-150-050/GD	1540	500	690	489	297	358	1,27	600	5,8	14,0	1.462,72	1.682,12
METM-180-050/GD	1750	500	775	551	336	404	1,26	750	7,1	16,8	1.566,21	1.801,15
METM-180-060/GD	1750	600	889	630	383	461	1,27	900	7,8	19,5	1.614,51	1.856,70

¹⁾ Maximum operating pressure for dual energy operation is 4 bar

^① For special colours in categories 1 and 2, see “Special solutions” and “Colour chart”

^③ Thermal output to EN 442, ΔT 50 K (75/65/20°C)

^④ For Completto version (with integrated valve), note greater height; total height H_t = H + 175 mm

For legend, see “Electric operation and Ecodesign Directive” on page 173

Zehnder Metropolitan Spa

Electric-only operation



Painted version

Model	H mm	L mm	Classification Electric heating element Watt	Price	Price ^①
				RAL 9016 €	Cat. 1 €
METE-080-040/GD	805	400	300	1.174,13	1.350,25
METE-150-040/GD	1540	400	500	1.443,76	1.660,33
METE-180-040/GD	1750	400	600	1.546,17	1.778,10
METE-120-050/GD	1225	500	500	1.315,78	1.513,14
METE-150-050/GD	1540	500	600	1.474,48	1.695,65
METE-180-050/GD	1750	500	750	1.578,62	1.815,40
METE-180-060/GD	1750	600	900	1.628,04	1.872,26

① For special colours in categories 1 and 2, see "Special solutions" and "Colour chart"

For legend, see "Electric operation and Ecodesign Directive" on page 173

Standard scope of delivery for operation on hot water central heating system

- Powder coating to DIN 55900, RAL 9016
- 4 x 1/2" connections for flow, return
- Completo: Pre-adjustable valve AV 9, chrome thermostat, connections: 2 x 3/4" external thread (at the back)
- Dual energy operation: Electric heating element RACY-S, pre-assembled on the right, with remote control device, incl. batteries, selectable operating modes: manual (above room temperature), weekly programme, timer, off
- 1/2" chrome directional air vent
- Mounting accessories in colour of radiator
- Packaging

Standard scope of delivery for electric operation

- Powder coating to DIN 55900, RAL 9016
- Filled with heat transfer fluid
- Electric heating element RACY-S with remote control device, incl. batteries, with selectable operating modes: manual (above room temperature), weekly programme, timer, off
- Mounting accessories in colour of radiator, with Technoline in RAL 7013 (brown-grey)
- Packaging

Special solution on request (surcharge)	Article number	Price €
■ Special finish to category 2 (surcharge on cat. 1)	M100011640	146,76
■ Special finish in Technoline (surcharge on cat. 1)	See colour chart	As in Cat. 2
■ Surface in metal look: stainless-steel look (reduced output approx. 8%)	M100012332	As in Cat. 1
■ Integrated valve including thermostat; note greater height (H _T = H + 175 mm, see drawing)	-	352,38
■ Side connection (both left or right); any connection size	-	186,33
■ Towel hook, for attaching, set of 2, chrome	480438	57,04
■ Towel rail for hanging towels on the side, for radiators of length 400, chrome	468038	156,06
■ Towel rail for hanging towels on the side, for radiators of length 500, chrome	468048	156,06
■ Towel rail for hanging towels, for radiators of length 600, chrome	468058	156,06
■ Towel rail for hanging towels, for radiators of length 900, chrome	468078	186,16
■ Zehnder thermostat SH, M 30 x 1,5, white or chrome	-	See page 164
■ Zehnder valves, lockshield valves and connection fittings	-	See p. 165 onwards

Operation on hot water central heating system:

Wall mounting

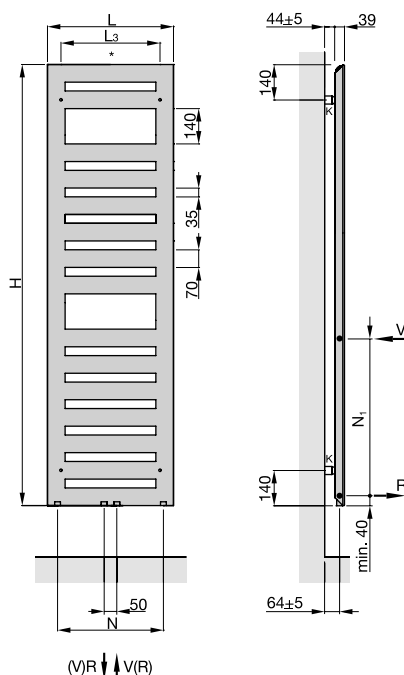

Integrated valve (Completo)¹⁾
Detailed view

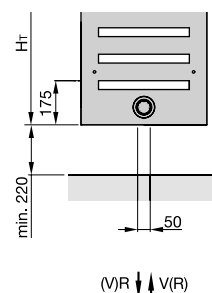

- H = Height
- L = Length
- L₃ = Fixing dimension, L - 106 mm
- K = Bracket
- V = Flow 1/2"
- R = Return 1/2"
- * = Venting 1/2"

Electric operation:
Detailed view

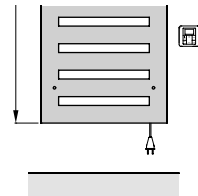

Dual energy operation:
Detailed view

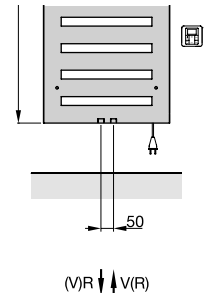

- N = Connection centre, L - 80 mm
- N₁ = Connection centre for side connection
- H_T = Total height, H + 175 mm

Dimensions in mm

- 1) Without internal by-pass for single-tube operation, not possible with dual energy operation
- 2) Distance from bottom edge of radiator to middle of connection

Zehnder Metropolitan Bar



Radiator colour: Traffic White



Operation on hot water central heating system

Zehnder Metropolitan Bar decorative radiator for use as a bathroom and towel radiator. Flat-looking radiator with recessed slots, made from horizontally arranged flat tubes 70 x 8 mm, which are connected with a surrounding triangular profile frame without visible welded joints. With even structure incl. towel rail. Thermal output to EN 442; with CE marking. With 4 connections at bottom, 2 x central 1/2" for flow/return, spacing 50 mm and 2 x 1/2", outside left and right, with directional air vent.

Connections for Completto version: Flow/return 2 x 3/4" external thread at the back, centred 50 mm spacing, including valve and thermostat integrated into front panel.

Connections for dual energy operation: Flow/return 2 x 1/2" at bottom centre, spacing 50 mm and factory covered integrated electric heating element RACY-S, bottom right, with separate remote control device model 2.

Radiator with powder coating, in colour RAL 9016 as standard, in special colour on request. Delivered ready to install with matching wall brackets and packaging.

Electric operation

Zehnder Metropolitan Bar decorative radiator, electric-only, for use as a bathroom and towel radiator. Flat-looking radiator with recessed slots, made from horizontally arranged flat tubes 70 x 8 mm, which are connected with a surrounding triangular profile frame without visible welded joints. With even structure incl. towel rail.

Electric heating element RACY-S integrated elegantly in the frame profile, with connection cable (1,2 m), with Euro plug. Installation at bottom right. Dry-running protection against operation without sufficient heat transfer fluid, degree of protection IP44 (splash-proof), for mains power supply of 230 V.

Separate, battery-operated remote control device model 2 for controlling the room temperature.

Standard version with powder coating, in colour RAL 9016, in special colour on request. Filled with heat transfer fluid. Delivered ready to install with elegant wall brackets.

Operating pressure	max. 4,0 bar
Hot water central heating system operating temperature	max. 110°C
Dual energy operation operating temperature (model MEPM)	max. 95°C
Height mm
Length mm
Model

Output Watt
Height mm
Length mm
Model

Benefits

- Innovative radiator with flat design
- Clean look due to innovative welding technology
- Model with towel rail for easy hanging of towels
- Individually positionable designer towel hook
- Elegant solutions for valve integration on request
- Dual energy operation: electric heating element RACY-S integrated elegantly
- Side connections for easy replacement of old DIN standard radiators on request

Special benefits for electric operation with RACY-S

- Remote control device can be positioned as required
- Regulated room temperature
- Comfortable operation as needed by customisable daily and weekly programmes
- Energy-efficient and comfortable heating via innovative open window detection
- Low energy consumption in stand-by mode ($\leq 0,5$ W)
- Keylock can be activated as required
- Timer function for up to 2 hours
- Ready-to-plug

Zehnder Metropolitan Bar

Overview of models

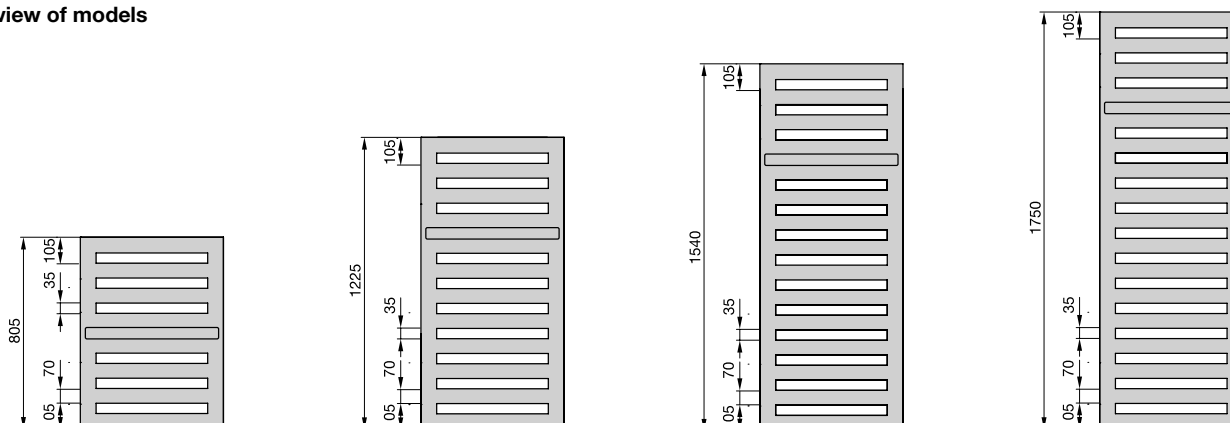

Connection to hot water central heating system

Painted version with chrome-plated towel rail

Model	H ^① mm	L mm	Thermal output				Exp. n	Classification Electric heating element Watt	V dm ³	M kg	Price RAL 9016 €	Price ^② Cat. 1 €
			EN 442 ^③ W	70/55/24 W	55/45/24 W	55/45/20 W						
MEP-080-040	805	400	323	228	137	166	1,29	-	3,5	6,8	836,22	1.045,27
MEP-120-040	1225	400	469	332	201	242	1,28	-	4,9	10,3	918,14	1.147,67
MEP-150-040	1540	400	582	418	259	310	1,22	-	5,5	12,0	1.064,92	1.331,15
MEP-180-040	1750	400	663	467	282	340	1,29	-	6,7	14,4	1.179,24	1.474,05
MEP-080-050	805	500	387	273	165	199	1,29	-	4,0	8,2	851,57	1.064,47
MEP-120-050	1225	500	563	398	241	291	1,28	-	5,5	12,4	935,21	1.169,01
MEP-150-050	1540	500	730	523	323	387	1,23	-	6,2	14,4	1.085,39	1.356,74
MEP-180-050	1750	500	795	561	338	408	1,29	-	7,6	17,4	1.201,41	1.501,76
MEP-080-060	805	600	449	317	191	231	1,29	-	4,4	9,7	875,46	1.094,32
MEP-120-060	1225	600	653	462	279	337	1,28	-	6,1	14,5	960,79	1.201,00
MEP-150-060	1540	600	871	624	385	461	1,23	-	7,0	16,8	1.116,10	1.395,12
MEP-180-060	1750	600	922	650	392	473	1,29	-	8,5	20,4	1.235,57	1.544,46

Painted version with chrome-plated towel rail for installation below windows

Model	H mm	L mm	Thermal output				Exp. n	Classification Electric heating element Watt	V dm ³	M kg	Price RAL 9016 €	Price ^② Cat. 1 €
			EN 442 ^③ W	70/55/24 W	55/45/24 W	55/45/20 W						
MEP-060-090	595	900	447	314	189	228	1,30	-	4,7	10,1	930,10	1.162,61
MEP-070-090	700	900	517	364	218	264	1,30	-	5,2	11,8	950,57	1.188,20

Connection for dual energy operation with integrated electric heating element*



Painted version with chrome-plated towel rail

Model	H mm	L mm	Thermal output				Exp. n	Classification Electric heating element Watt	V dm ³	M kg	Price RAL 9016 €	Price ^② Cat. 1 €
			EN 442 ^③ W	70/55/24 W	55/45/24 W	55/45/20 W						
MEPM-120-050/GD	1225	500	563	398	241	291	1,28	500	5,4	13,3	1.467,90	1.688,07
MEPM-150-050/GD	1540	500	730	523	323	387	1,23	600	6,1	15,4	1.631,76	1.876,53
MEPM-180-050/GD	1750	500	795	561	338	408	1,29	750	7,5	18,3	1.740,42	2.001,49
MEPM-180-060/GD	1750	600	922	650	392	473	1,29	900	8,4	21,4	1.790,47	2.059,04

* Maximum operating pressure for dual energy operation is 4 bar

① For special colours in categories 1 and 2, see “Special solutions” and “Colour chart”

② Thermal output to EN 442, ΔT 50 K (75/65/20°C)

③ For Completto version (with integrated valve), note greater height; total height H_t = H + 175 mm

For legend, see “Electric operation and Ecodesign Directive” on page 173

Zehnder Metropolitan Bar



Electric-only operation



Painted version with chrome-plated towel rail

Model	H	L	Classification Electric heating element Watt	Price	Price ^①
	mm	mm		RAL 9016 €	Cat. 1 €
MEPE-080-040/GD	805	400	300	1.314,07	1.511,18
MEPE-150-040/GD	1540	400	500	1.622,91	1.866,35
MEPE-180-040/GD	1750	400	600	1.718,51	1.976,30
MEPE-120-050/GD	1225	500	500	1.476,19	1.697,61
MEPE-150-050/GD	1540	500	600	1.641,73	1.887,98
MEPE-180-050/GD	1750	500	750	1.750,95	2.013,59
MEPE-180-060/GD	1750	600	900	1.802,17	2.072,49

Standard scope of delivery for operation on hot water central heating system

- Powder coating to DIN 55900, RAL 9016
- 4 x ½" connections for flow, return
- Completo: Pre-adjustable valve AV 9, chrome thermostat, connections: 2 x ¾" external thread (at the back)
- Dual energy operation: Electric heating element RACY-S, pre-assembled on the right, with remote control device, incl. batteries, selectable operating modes: manual (above room temperature), weekly programme, timer, off
- ½" chrome directional air vent
- Towel rail in chrome
- Mounting accessories in colour of radiator
- Packaging

Standard scope of delivery for electric operation

- Powder coating to DIN 55900, RAL 9016
- Filled with heat transfer fluid
- Electric heating element RACY-S with remote control device, incl. batteries, with selectable operating modes: manual (above room temperature), weekly programme, timer, off
- Towel rail in chrome
- Mounting accessories in colour of radiator, with Technoline in RAL 7013 (brown-grey)
- Packaging

Special solution on request (surcharge)	Article number	Price €
■ Special finish to category 2 (surcharge on cat. 1)	M100011640	146,76
■ Special finish in Technoline (surcharge on cat. 1)	See colour chart	As in Cat. 2
■ Surface in metal look: stainless-steel look (reduced output approx. 8%)	M100012332	As in Cat. 1
■ Integrated valve including thermostat; note greater height ($H_T = H + 175$ mm, see drawing)	-	352,38
■ Side connection (both left or right); any connection size	-	186,33
■ Towel hook, for attaching, set of 2, chrome	480438	57,04
■ Towel rail for hanging towels on the side (295 mm in length), for radiators of length 400, chrome	468038	156,06
■ Towel rail for hanging towels on the side (395 mm in length), for radiators of length 500, chrome	468048	156,06
■ Towel rail for hanging towels (495 mm in length), for radiators of length 600, chrome	468058	156,06
■ Towel rail for hanging towels (795 mm in length), for radiators of length 900, chrome	468078	186,16
■ Zehnder thermostat SH, M 30 x 1,5, white	819080	38,09
■ Zehnder thermostat SH, M 30 x 1,5, chrome	819088	53,47
■ Zehnder valves, lockshield valves and connection fittings	-	See p. 165 onwards

① For special colours in categories 1 and 2, see "Special solutions" and "Colour chart"

For legend, see "Electric operation and Ecodesign Directive" on page 173

Zehnder Metropolitan Bar

Operation on hot water central heating system:

Wall mounting

Integrated valve (Completo)¹⁾

Electric operation:

Dual energy operation:

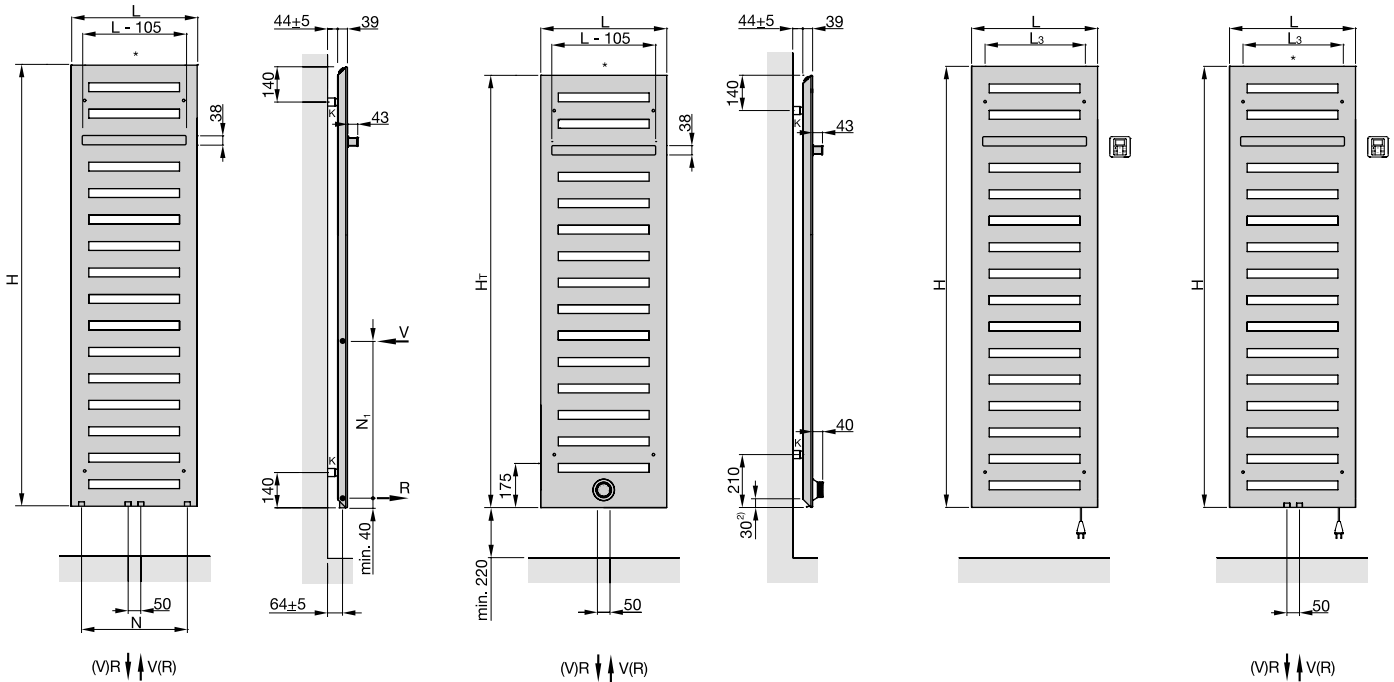

Operation on hot water central heating system:

Version for installation below windows

- H = Height
- L = Length
- L₃ = Fixing dimension, L - 106 mm
- K = Bracket
- V = Flow 1/2"
- R = Return 1/2"
- * = Venting 1/2"
- N = Connection centre, L - 80 mm
- N₁ = Connection centre for side connection
- H_T = Total height, H + 175 mm

Dimensions in mm

- 1) Without internal by-pass for single-tube operation, not possible with dual energy operation
- 2) Distance from bottom edge of radiator to middle of connection

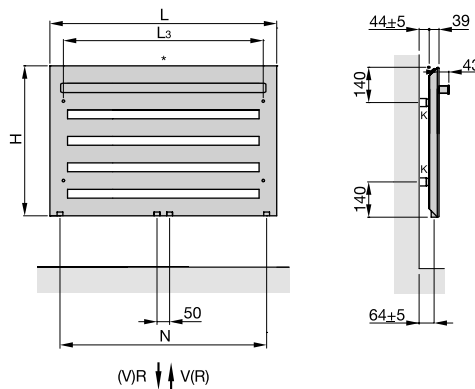

Zehnder Kazeane



Radiator colour: Black Matt

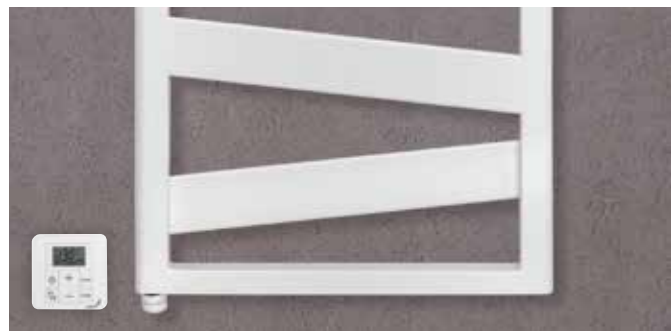

Radiator colour: Ruby Red, Traffic White

Operation on hot water central heating system

Zehnder Kazeane decorative radiator made from vertically arranged D-profile tubes rounded at the outside, 30 x 40 mm, plus offset and diagonally arranged flat tubes, 70 x 8 mm, which wrap around the bathroom radiator like a steel band. The resulting generous cut-outs on two levels create space for hanging several towels. Additionally, one or two horizontal flat tubes, depending on height. D-profile tubes arranged at the top and side, plus square tube, 30 x 30 mm, at bottom create a functional mounting plate.

Thermal output to EN 442, with CE marking. With 4 connections at bottom, 2 x central 1/2" for flow/return, spacing 50 mm and 2 x 1/2", outside left and right, with directional air vent.

Radiator with powder coating, in colour RAL 9016 as standard, in special colour on request. Delivered ready to install with matching wall brackets and packaging.

Operating pressure	max. 4,0 bar
Operating temperature	max. 110°C
Height mm
Length mm
Model

Benefits

- Individuality through exceptional design
- Many different heights at which to hang a towel
- The arrangement of the flat tubes on two levels makes it easier to hang multiple towels – ideal for families
- Inconspicuous brackets concealed behind header tube
- Ample spaces between tubes make cleaning easy

Electric operation

Zehnder Kazeane decorative radiator, electric-only, made from vertically arranged D-profile tubes rounded at the outside, 30 x 40 mm, plus offset and diagonally arranged flat tubes, 70 x 8 mm, which wrap around the bathroom radiator like a steel band. The resulting generous cut-outs on two levels create space for hanging several towels. Also features one horizontal flat tube. D-profile tubes arranged at the top and side, plus square tube, 30 x 30 mm, at bottom create a functional mounting plate.

With integrated electric heating element RACY-C, degree of protection IP44 (splash-proof), for mains power supply of 230 V. With connection cable 1,2 m in length, with two-pin plug. Installation at bottom left. Decorative radiator filled with heat transfer fluid. Separate, battery-operated remote control device model 2 for controlling the room temperature. Radiator with powder coating, in colour RAL 9016 as standard, in special colour or chrome-plated. Delivered ready to install with matching wall brackets and packaging.

Output Watt
Height mm
Length mm
Model

Special benefits for electric operation with RACY-C

- Remote control device can be positioned as required
- Regulated room temperatures
- Comfortable operation as needed by customisable daily and weekly programmes
- Energy-efficient and comfortable heating via innovative open window detection
- Low energy consumption in stand-by mode ($\leq 0,5$ W)
- Keylock can be activated as required
- Timer function for up to 2 hours
- Ready-to-plug

Zehnder Kazeane

Overview of models Length 500

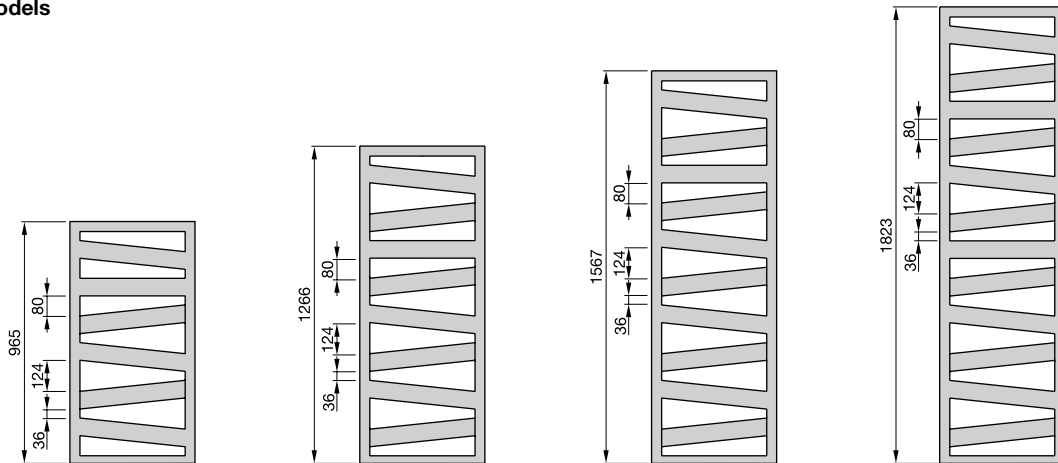

Overview of models Length 600

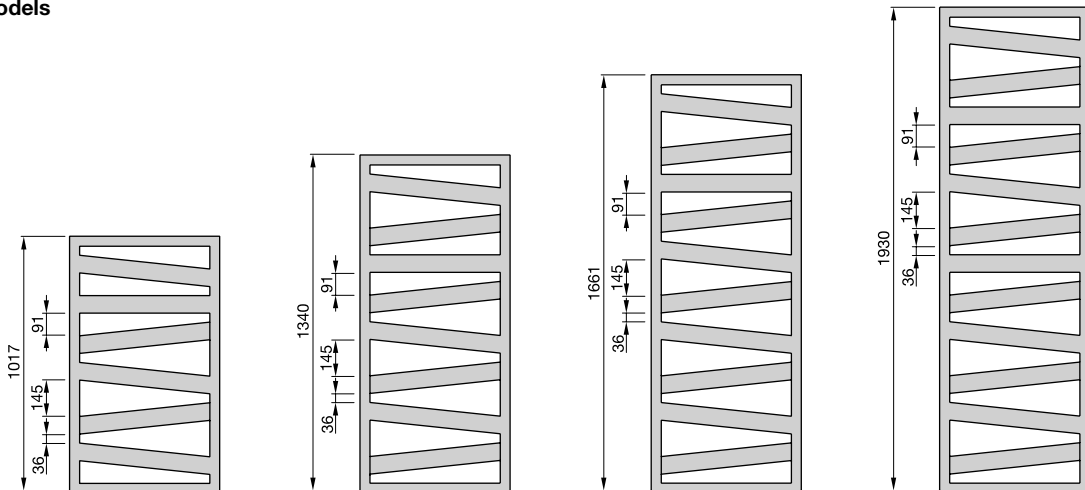

Connection to hot water central heating system

Painted version

Model	H mm	L mm	Thermal output				Exp. n	Classification Electric heating element Watt	V dm ³	M kg	Price RAL 9016 €	Price ^① Cat. 1 €
			EN 442 ^② W	70/55/24 W	55/45/24 W	55/45/20 W						
RK-100-050	965	500	398	284	175	210	1,24	300	3,4	8,4	636,02	795,02
RK-130-050	1266	500	509	364	224	268	1,24	300	4,1	10,7	707,52	884,40
RK-160-050	1567	500	621	445	275	329	1,23	600	4,8	13,1	822,76	1.028,44
RK-180-050	1823	500	723	515	316	379	1,25	600	5,7	15,1	924,88	1.156,11
RK-100-060	1017	600	473	337	206	248	1,25	300	3,8	9,9	656,46	820,58
RK-130-060	1340	600	608	435	267	320	1,24	600	4,6	12,6	730,85	913,56
RK-170-060	1661	600	743	531	327	391	1,24	600	5,4	15,4	862,14	1.077,67
RK-190-060	1930	600	847	604	370	444	1,25	600	6,5	18,0	948,22	1.185,28

Chrome-plated version

Model	H mm	L mm	Thermal output				Exp. n	Classification Electric heating element Watt	V dm ³	M kg	Price Chrome €
			EN 442 ^② W	70/55/24 W	55/45/24 W	55/45/20 W					
RKC-100-050	965	500	261	187	114	137	1,27	-	3,4	8,5	1.334,79
RKC-130-050	1266	500	327	235	142	171	1,27	300	4,1	10,8	1.485,05
RKC-160-050	1567	500	393	282	171	205	1,28	300	4,8	13,1	1.730,12
RKC-180-050	1823	500	461	330	199	240	1,28	300	5,7	15,4	1.959,16
RKC-100-060	1017	600	304	218	132	158	1,28	300	3,8	10,0	1.377,10
RKC-130-060	1340	600	386	277	168	201	1,27	300	4,6	12,7	1.590,07
RKC-170-060	1661	600	468	336	204	245	1,27	300	5,4	15,4	1.805,99
RKC-190-060	1930	600	544	390	236	283	1,28	300	6,5	17,9	2.020,42

① For special colours in categories 1 and 2, see "Special solutions" and "Colour chart"

② Thermal output to EN 442, ΔT 50 K (75/65/20°C)

Electric-only operation



Painted version

Model	H	L	Classification Electric heating element Watt	Price	Price ^①
	mm	mm		RAL 9016 €	Cat. 1 €
RK-130-050/GD	1291	500	500	1.236,55	1.422,03
RK-160-050/GD	1592	500	600	1.414,64	1.626,85
RK-130-060/GD	1365	600	600	1.407,51	1.618,63
RK-170-060/GD	1686	600	750	1.598,40	1.838,15

Chrome-plated version

Model	H*	L	Classification Electric heating element Watt	Price
	mm	mm		Chrome €
RKC-130-050/GD	1291	500	300	2.059,81
RKC-160-050/GD	1592	500	300	2.357,41
RKC-130-060/GD	1365	600	300	2.390,97
RKC-170-060/GD	1686	600	500	2.802,34

*Total height incl. electric heating element

Standard scope of delivery for operation on hot water central heating system

- Powder coating to DIN 55900, RAL 9016
- 4 x ½" connections for flow, return
- ½" directional air vent
- Mounting accessories in colour of radiator
- Packaging

Standard scope of delivery for electric operation

- Powder coating to DIN 55900, RAL 9016
- Filled with heat transfer fluid
- With integrated electric heating element RACY-C, bottom left
- Electric heating element cover in colour of radiator
- Control panel in white; with chrome-plated cover in the case of chrome-plated radiators
- Mounting accessories in colour of radiator
- Packaging

Special solution on request (surcharge)	Article number	Price €
■ Special finish to category 2 (surcharge on cat. 1)	M100011640	146,76
■ Surface in metal look: stainless-steel look (reduced output approx. 8%)	M100012332	As in Cat. 1
■ Towel hook, for attaching, set of 2, chrome	480438	57,04
■ Zehnder valves, lockshield valves and connection fittings	-	See p. 165 onwards

Operation on hot water central heating system:

Wall mounting

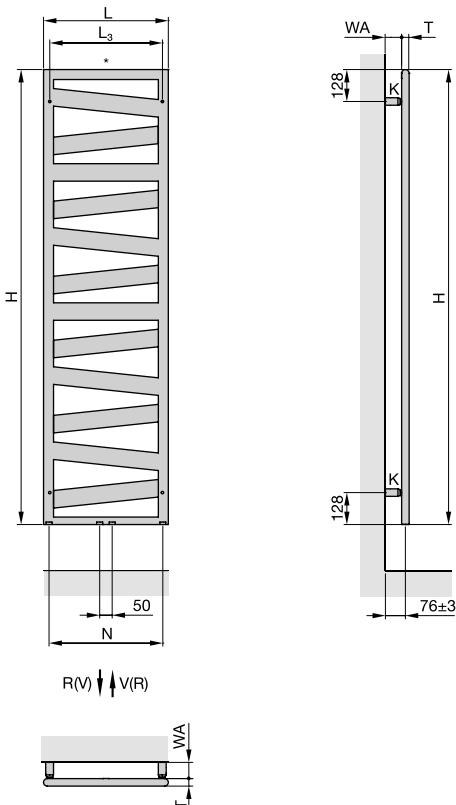

Electric operation:

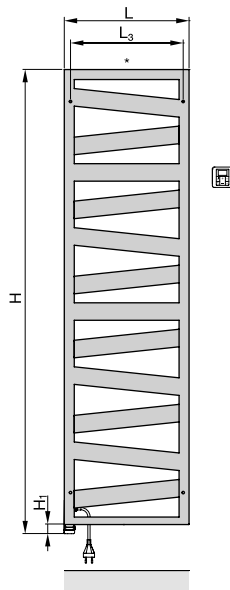

Dual energy operation:

Connection to hot water central heating system with electric heating element (fig. with DBM)

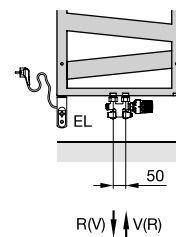

- H = Height
- H₁ = 25 mm
- L = Length
- T = Depth = 30 mm
- K = Bracket
- WA = Wall clearance = 61±3 mm
- V = Flow ½"
- R = Return ½"
- * = Venting ½"
- N = Connection centre, L - 44 mm
- L₃ = Fixing dimension, L - 49 mm

Dimensions in mm

Zehnder Roda Spa Asym



Radiator colour: Light Jeans



Operation on hot water central heating system

Zehnder Roda Spa Asym decorative radiator made from horizontally arranged precision flat tubes and vertical header tubes, without visible welds and fully welded.

Single-sided, asymmetrically arranged flat tubes 70 x 11 mm branching laterally from the manifold Ø 38 mm; towels can be easily slid in from the side to warm.

Thermal output tested to EN 442, with CE marking. With connections at bottom, 2 x 1/2" for flow/return, connection centre 50 mm, with directional air vent.

Radiator with powder coating, in colour RAL 9016 as standard, in special colour on request. Delivered ready to install with wall brackets in colour of radiator.

Operating pressure	max. 4 bar
Operating temperature	max. 110°C
Height mm
Length mm
Model

Benefits

- Open access from both sides makes it very convenient for hanging and sliding towels in from the side
- Diverse range of models with left-hand or right-hand version

Standard scope of delivery for operation on central heating system

- Powder coating to DIN 55900, RAL 9016
- 2 x 1/2" connections for flow, return
- 1/8" directional air vent
- Mounting accessories in colour of radiator
- Packaging

Zehnder Roda Spa Asym



Overview of models

Right-hand version

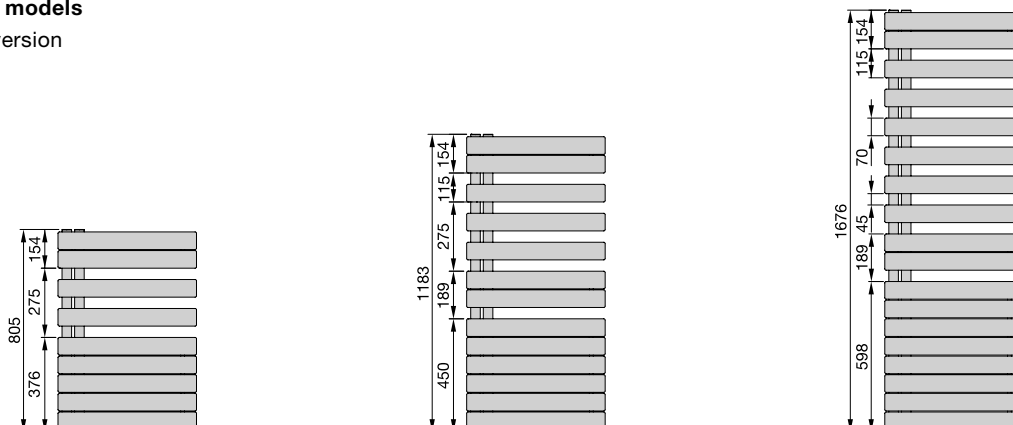

Connection to hot water central heating system

Painted version

Model	H mm	L mm	Thermal output				Exp. n	Classification Electric heating element Watt	V dm ³	M kg	Price RAL 9016 €	Price ^① Cat. 1 €
			EN 442 ^③ W	70/55/24 W	55/45/24 W	55/45/20 W						
Right-hand version												
ROFR-080-055	805	550	429	307	189	227	1,24	-	4,3	10,1	773,66	967,08
ROFR-120-055	1183	550	594	424	260	312	1,25	-	6,3	14,5	885,83	1.107,30
ROFR-170-055	1676	550	809	574	350	421	1,26	-	8,8	20,0	1.098,64	1.373,30
Left-hand version												
ROFL-080-055	805	550	429	307	189	227	1,24	-	4,3	10,1	773,66	967,08
ROFL-120-055	1183	550	594	424	260	312	1,25	-	6,3	14,5	885,83	1.107,30
ROFL-170-055	1676	550	809	574	350	421	1,26	-	8,8	20,0	1.098,64	1.373,30

Special solution on request (surcharge)	Article number	Price €
■ Special finish to category 2 (surcharge on cat. 1)	R200011640	146,76
■ Zehnder valves, lockshield valves and connection fittings	-	See p. 165 onwards

① For special colours in categories 1 and 2, see “Special solutions” and “Colour chart”

③ Thermal output according to EN 442, ΔT 50 K (75/65/20°C)

Zehnder Roda Spa Asym

Operation on hot water central heating system:
 Right-hand version

Left-hand version

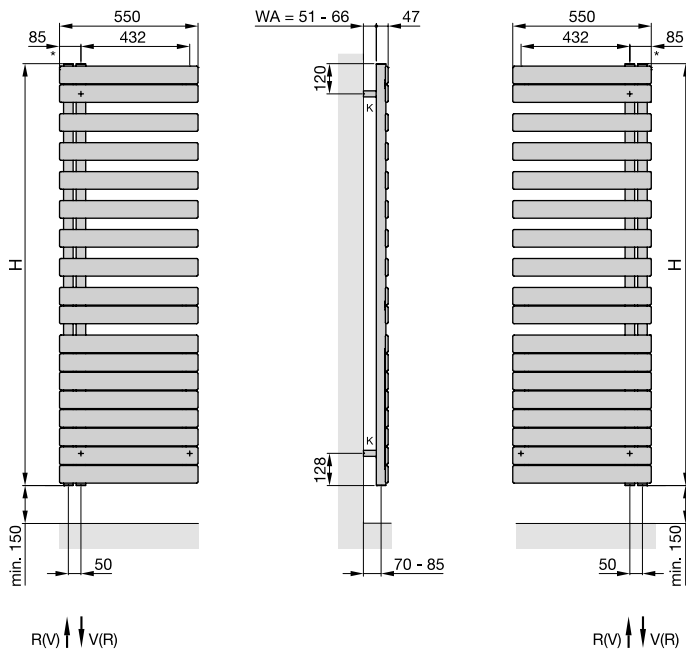

- WA = Wall clearance
- K = Bracket
- V = Flow 1/2"
- R = Return 1/2"
- * = Venting 1/8"

Dimensions in mm

Zehnder Quaro



Radiator colour: Volcanic



Operation on hot water central heating system

Zehnder Quaro decorative radiator made from horizontally arranged precision steel tubes with surrounding square tubes, fully welded, invisible welds due to laser welding technology. Square tubes 25 x 25 mm, regularly arranged in the frame of square 30 x 30 mm tube.

Thermal output tested to EN 442, with CE marking.

With recessed connections on lower square tube, central 1/2" for flow/return, connection centre 50 mm and outside left and right 1/2" for electric heating element, with directional air vent.

Connections for dual energy operation: Flow/return 2 x 1/2" at bottom centre, spacing 50 mm and factory integrated electric heating element RACY-S, bottom right, with separate remote control device model 2.

Radiator with powder coating, in colour RAL 9016 as standard, in special colour, chrome or version in brushed V4A stainless steel on request.

Delivered ready to install with matching wall brackets and packaging.

Room divider version: Radiator without attachment welded at back for wall bracket, incl. room divider mounting set.

Electric operation

Zehnder Quaro decorative radiator, electric-only, made from horizontally arranged precision steel tubes with surrounding square tubes, fully welded, invisible welds due to laser welding technology.

Electric heating element RACY-S integrated elegantly underneath the frame profile, with connection cable (1,2 m), with Euro plug. Installation at bottom right. Dry-running protection against operation without sufficient heat transfer fluid, degree of protection IP44 (splash-proof), for mains power supply of 230 V. Separate, battery-operated remote control device model 2 for wall mounting for controlling the room temperature.

Standard version with powder coating, in colour RAL 9016, special colour, chrome or version in brushed V4A stainless steel on request. Filled with heat transfer fluid.

Delivered ready to install with elegant wall brackets.

Operating pressure	max. 10,0 bar
Hot water central heating system operating temperature	max. 110°C
Dual energy operation operating temperature (model QAM)	max. 95°C
Height mm
Length mm
Model

Output Watt
Height mm
Length mm
Model

Benefits

- Geometric clarity with consistent look
- Many different heights at which to hang a towel
- Hygienic and easy to clean
- Discreetly concealed brackets
- Also available as room divider version
- Dual energy operation: electric heating element RACY-S integrated elegantly

Special benefits for electric operation with RACY-S

- Remote control device can be positioned as required
- Regulated room temperature
- Comfortable operation as needed by customisable daily and weekly programmes
- Energy-efficient and comfortable heating via innovative open window detection
- Low energy consumption in stand-by mode ($\leq 0,5$ W)
- Keylock can be activated as required
- Timer function for up to 2 hours
- Ready-to-plug

Zehnder Quaro

Overview of models

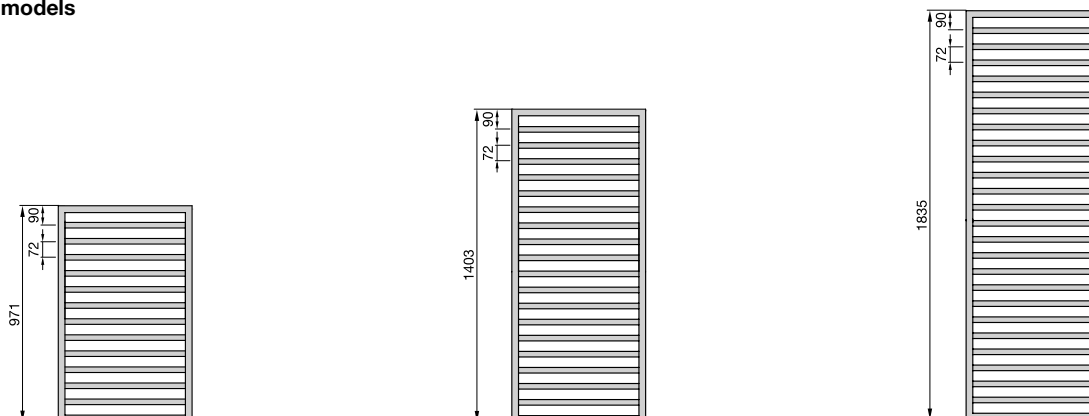

Connection to hot water central heating system

Painted version

Model	H mm	L mm	Thermal output				Exp. n	Classification Electric heating element Watt	V dm ³	M kg	Price RAL 9016 €	Price ^① Cat. 1 €
			EN 442 ^③ W	70/55/24 W	55/45/24 W	55/45/20 W						
QA-100-030	971	300	299	214	131	158	1,24	300	3,3	5,7	656,79	820,98
QA-140-030	1403	300	421	301	185	222	1,24	300	4,7	7,9	689,98	862,47
QA-180-030	1835	300	543	389	240	288	1,23	300	6,0	10,1	917,18	1.146,47
QA-100-045	971	450	420	300	185	221	1,24	300	4,4	7,8	694,94	868,67
QA-140-045	1403	450	590	423	261	312	1,23	500	6,3	10,6	729,79	912,24
QA-180-045	1835	450	761	545	337	403	1,23	600	8,1	13,8	965,27	1.206,60
QA-100-060	971	600	533	382	236	282	1,23	300	5,5	9,8	733,07	916,35
QA-140-060	1403	600	749	537	331	397	1,23	600	7,9	13,4	771,21	964,03
QA-180-060	1835	600	966	692	427	512	1,23	900	10,2	17,0	1.015,03	1.268,79

Chrome-plated version

Model	H mm	L mm	Thermal output				Exp. n	Classification Electric heating element Watt	V dm ³	M kg	Price Chrome €
			EN 442 ^③ W	70/55/24 W	55/45/24 W	55/45/20 W					
QAC-100-030	971	300	189	133	80	97	1,30	-	3,3	5,8	1.378,28
QAC-140-030	1403	300	270	190	114	138	1,30	300	4,7	7,6	1.449,58
QAC-180-030	1835	300	348	245	147	178	1,30	300	6,0	10,3	1.917,28
QAC-100-045	971	450	267	188	114	137	1,29	300	4,4	7,9	1.456,23
QAC-140-045	1403	450	381	269	162	196	1,29	300	6,3	10,2	1.530,86
QAC-180-045	1835	450	491	345	207	252	1,29	300	8,1	13,8	2.023,44
QAC-100-060	971	600	341	241	146	176	1,28	300	5,5	10,0	1.534,17
QAC-140-060	1403	600	486	343	207	250	1,29	300	7,9	12,9	1.613,77
QAC-180-060	1835	600	627	442	267	322	1,29	600	10,2	17,2	2.129,60

① For special colours in categories 1 and 2, see "Special solutions" and "Colour chart"

③ Thermal output to EN 442, ΔT 50 K (75/65/20°C)

Zehnder Quaro



Connection to hot water central heating system

Stainless-steel version

Model	H mm	L mm	Thermal output				Exp. n	Classification Electric heating element Watt	V dm ³	M kg	Price Stainless steel €
			EN 442 ^③ W	70/55/24 W	55/45/24 W	55/45/20 W					
QAI-100-030	971	300	229	162	99	119	1,27	-	3,3	6,0	1.708,33
QAI-140-030	1403	300	321	228	138	167	1,27	300	4,7	8,3	1.799,53
QAI-180-030	1835	300	415	294	179	215	1,27	300	6,2	10,6	2.580,71
QAI-100-045	971	450	321	228	139	167	1,26	300	4,5	7,8	1.824,39
QAI-140-045	1403	450	450	320	195	235	1,26	300	6,3	10,8	1.920,60
QAI-180-045	1835	450	581	413	252	303	1,26	300	8,1	13,8	2.749,89
QAI-100-060	971	600	407	289	176	212	1,26	300	5,7	9,6	1.938,84
QAI-140-060	1403	600	572	407	248	298	1,26	300	7,9	13,3	2.040,01
QAI-180-060	1835	600	738	525	320	385	1,26	600	10,2	17,0	2.919,06

Connection for dual energy operation with integrated electric heating element



Painted version

Model	H ^④ mm	L mm	Thermal output				Exp. n	Classification Electric heating element Watt	V dm ³	M kg	Price RAL 9016 €	Price ^① Cat. 1 €
			EN 442 ^③ W	70/55/24 W	55/45/24 W	55/45/20 W						
QAM-100-045/GD	1001	450	420	300	185	222	1,23	300	4,4	7,8	1.204,11	1.384,73
QAM-140-045/GD	1433	450	590	423	261	312	1,23	500	6,3	10,6	1.302,01	1.497,30
QAM-180-045/GD	1865	450	761	545	337	403	1,23	600	8,1	13,8	1.539,14	1.770,01
QAM-140-060/GD	1433	600	749	537	331	397	1,23	600	7,9	13,4	1.418,07	1.630,78
QAM-180-060/GD	1865	600	966	692	427	512	1,23	900	10,2	17,0	1.597,19	1.836,78

Chrome-plated version

Model	H ^④ mm	L mm	Thermal output				Exp. n	Classification Electric heating element Watt	V dm ³	M kg	Price Chrome €
			EN 442 ^③ W	70/55/24 W	55/45/24 W	55/45/20 W					
QAMC-140-045/GD	1433	450	381	269	162	196	1,29	300	6,3	10,8	2.688,51
QAMC-180-045/GD	1865	450	491	345	207	252	1,29	300	8,1	13,8	3.199,33
QAMC-140-060/GD	1433	600	486	343	207	250	1,29	300	7,9	13,3	2.967,15
QAMC-180-060/GD	1865	600	627	442	267	322	1,29	600	10,2	17,0	3.327,05

① For special colours in categories 1 and 2, see "Special solutions" and "Colour chart"

③ Thermal output to EN 442, ΔT 50 K (75/65/20°C)

④ Total height incl. electric heating element

For legend, see "Electric operation and Ecodesign Directive" on page 173

Zehnder Quaro

Electric-only operation



Painted version

Model	H ^②	L	Classification Electric heating element Watt	Price	Price ^①
	mm			RAL 9016 €	Cat. 1 €
QAE-100-045/GD	1001	450	300	1.204,11	1.384,73
QAE-140-045/GD	1433	450	500	1.302,01	1.497,30
QAE-180-045/GD	1865	450	600	1.539,14	1.770,01
QAE-140-060/GD	1433	600	600	1.418,07	1.630,78
QAE-180-060/GD	1865	600	900	1.597,19	1.836,78

Chrome-plated version

Model	H ^②	L	Classification Electric heating element Watt	Price
	mm			Chrome €
QAEC-140-045/GD	1433	450	300	2.688,51
QAEC-180-045/GD	1865	450	300	3.199,33
QAEC-140-060/GD	1433	600	300	2.967,15
QAEC-180-060/GD	1865	600	600	3.327,05

Standard scope of delivery for operation on hot water central heating system

- Powder coating to DIN 55900, RAL 9016
- 4 x ½" connections, connection centre 50 mm female thread for flow/return and electric heating element (on site) on left or right
- Dual energy operation: Electric heating element RACY-S, pre-assembled on the right, with remote control device, incl. batteries, with selectable operating modes: manual (above room temperature), weekly programme, timer, off. Electric heating element cover in colour of radiator
- Designer directional air vent, chrome ½"
- Mounting accessories in colour of radiator
- Packaging

Standard scope of delivery for electric operation

- Powder coating to DIN 55900, RAL 9016
- Filled with heat transfer fluid
- Electric heating element RACY-S with remote control device, incl. batteries, with selectable operating modes: manual (above room temperature), weekly programme, timer, off
- Mounting accessories and electric heating element control box cover in colour of radiator
- Packaging

Special solution on request (surcharge)	Article number	Price €
■ Special finish to category 2 (surcharge on cat. 1)	QA00011640	146,76
■ Room divider version with two wall brackets and foot support, white, chrome, special colour	-	257,07
■ Room divider version with two wall brackets without foot support, white, chrome, special colour	-	199,02
■ Models for electric operation in room divider version	-	On request
■ Zehnder valves, lockshield valves and connection fittings	-	See p. 165 onwards

① For special colours in categories 1 and 2, see "Special solutions" and "Colour chart"

② Total height incl. electric heating element

For legend, see "Electric operation and Ecodesign Directive" on page 173 

Zehnder Quaro



Operation on hot water central heating system:

Wall mounting
(with attached welded brackets)

Room divider installation
(special version without attached welded brackets in ²⁾)

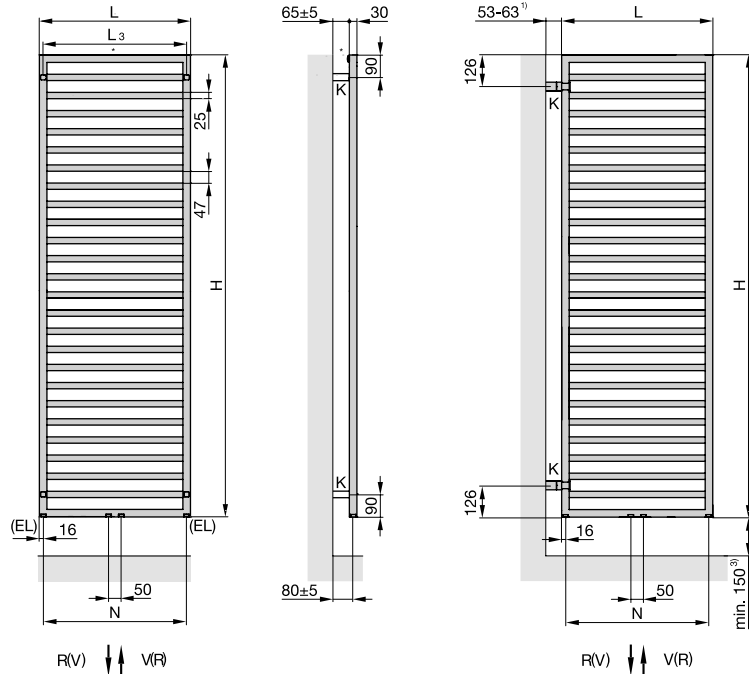

Electric operation:

Dual-energy operation:

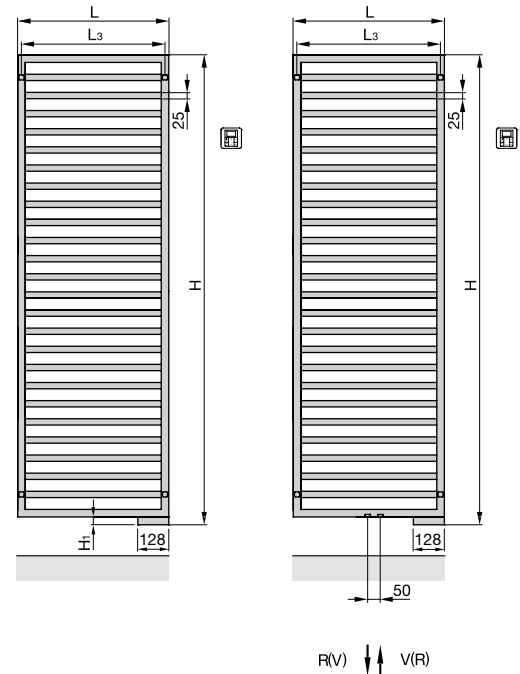

- H = Height
- H₁ = 30 mm
- L = Length
- EL = Connection for electric heating element
- K = Bracket
- V = Flow 1/2"
- R = Return 1/2"
- * = Venting 1/2"
- N = Connection centre
- L₃ = Fixing dimension, L - 30 mm

Dimensions in mm

- 1) Lengthening possible with brackets for larger wall clearance
- 2) The standard version of the radiator is not suitable for room divider installation
- 3) Max. 170 mm for installation with foot support in standard length

Zehnder Subway



Radiator surface: Chrome



Operation on hot water central heating system

Zehnder Subway decorative radiator made from horizontally arranged precision steel tubes with surrounding square tubes, fully welded, invisible welds due to laser welding technology. Round tubes Ø 23 mm, regularly arranged in the frame of square 30 x 30 mm tube. Thermal output tested to EN 442, with CE marking. With recessed connections on lower square tube, central 1/2" for flow/return, connection centre 50 mm and outside left and right 1/2" for electric heating element, with directional air vent. Connections for dual energy operation: Flow/return 2 x 1/2" at bottom centre, spacing 50 mm and factory integrated electric heating element RACY-S, bottom right, with separate remote control device model 2. Radiator with powder coating, in colour RAL 9016 as standard, in special colour, chrome or version in brushed V4A stainless steel on request. Delivered ready to install with matching wall brackets and packaging. Room divider version: Radiator without threaded bolts for wall bracket, incl. room divider mounting set.

Electric operation

Zehnder Subway decorative radiator, electric-only, made from horizontally arranged precision steel tubes with surrounding square tubes, fully welded, invisible welds due to laser welding technology. Electric heating element RACY-S integrated elegantly underneath the frame profile, with connection cable (1,2 m), with Euro plug. Installation at bottom right. Dry-running protection against operation without sufficient heat transfer fluid, degree of protection IP44 (splash-proof), for mains power supply of 230 V. Separate, battery-operated remote control device model 2 for controlling the room temperature. Standard version with powder coating, in colour RAL 9016, special colour, chrome or version in brushed V4A stainless steel on request. Filled with heat transfer fluid. Delivered ready to install with elegant wall brackets.

Operating pressure	max. 10,0 bar
Hot water central heating system operating temperature	max. 110°C
Dual energy operation operating temperature (model SUBM)	max. 95°C
Height mm
Length mm
Model

Output Watt
Height mm
Length mm
Model

Benefits

- Classic design
- Outside frame lends geometric look
- Generous spacing to hang towels
- Variant in brushed stainless steel
- Also available as room divider version
- Special 150 mm connection available
- Extra model for use as guest WC radiator
- Dual energy operation: electric heating element RACY-S integrated elegantly

Special benefits for electric operation with RACY-S

- Remote control device can be positioned as required
- Regulated room temperature
- Comfortable operation as needed by customisable daily and weekly programmes
- Energy-efficient and comfortable heating via innovative open window detection
- Low energy consumption in stand-by mode (≤ 0,5 W)
- Keylock can be activated as required
- Timer function for up to 2 hours
- Ready-to-plug

Zehnder Subway



Overview of models

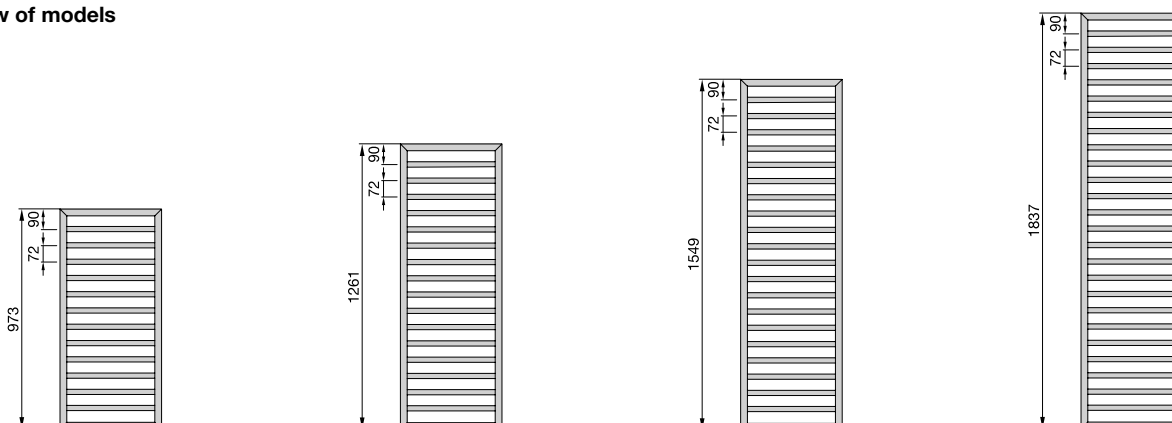

Connection to hot water central heating system

Painted version

Model	H mm	L mm	Thermal output				Exp. n	Classification Electric heating element Watt	V dm ³	M kg	Price RAL 9016 €	Price ^① Cat. 1 €
			EN 442 ^③ W	70/55/24 W	55/45/24 W	55/45/20 W						
SUB-100-045	973	450	401	286	175	210	1,25	300	3,5	6,7	392,68	490,84
SUB-130-045	1261	450	509	363	222	267	1,25	300	4,5	8,6	452,59	565,73
SUB-150-045	1549	450	615	438	268	322	1,25	600	5,4	10,6	532,44	665,54
SUB-180-045	1837	450	715	511	314	377	1,24	600	6,3	12,2	596,33	745,42
SUB-100-060	973	600	499	356	218	262	1,25	300	4,3	8,3	413,98	517,48
SUB-130-060	1261	600	639	455	279	335	1,25	600	5,4	10,5	475,65	594,56
SUB-150-060	1549	600	772	550	337	405	1,25	600	7,2	12,5	560,85	701,06
SUB-180-060	1837	600	898	642	395	473	1,24	900	7,7	14,7	628,33	785,40

Chrome-plated version

Model	H mm	L mm	Thermal output				Exp. n	Classification Electric heating element Watt	V dm ³	M kg	Price Chrome €
			EN 442 ^③ W	70/55/24 W	55/45/24 W	55/45/20 W					
SUBC-100-045	973	450	265	188	114	137	1,27	300	3,5	6,5	970,28
SUBC-130-045	1261	450	336	238	145	174	1,27	300	4,5	8,4	1.070,23
SUBC-150-045	1549	450	413	293	178	214	1,27	300	5,4	10,1	1.263,69
SUBC-180-045	1837	450	486	345	209	252	1,27	300	6,3	11,8	1.412,74
SUBC-100-060	973	600	329	234	143	172	1,26	300	4,3	8,1	1.022,12
SUBC-130-060	1261	600	408	290	177	213	1,26	300	5,4	10,2	1.127,01
SUBC-150-060	1549	600	502	357	218	262	1,26	300	7,2	12,3	1.329,37
SUBC-180-060	1837	600	590	419	256	308	1,26	600	7,7	14,3	1.487,30

Stainless-steel version

Model	H mm	L mm	Thermal output				Exp. n	Classification Electric heating element Watt	V dm ³	M kg	Price Stainless steel €
			EN 442 ^③ W	70/55/24 W	55/45/24 W	55/45/20 W					
SUBI-100-045	973	450	287	203	124	149	1,27	300	3,5	6,7	1.215,23
SUBI-130-045	1261	450	370	262	159	192	1,27	300	4,5	8,7	1.341,79
SUBI-150-045	1549	450	445	315	192	231	1,27	300	5,4	10,4	1.597,38
SUBI-180-045	1837	450	523	370	224	270	1,28	300	6,3	12,2	1.920,37
SUBI-100-060	973	600	356	253	154	186	1,26	300	4,3	8,3	1.292,15
SUBI-130-060	1261	600	447	318	194	233	1,26	300	5,4	10,4	1.425,18
SUBI-150-060	1549	600	538	383	235	282	1,25	300	7,2	12,4	1.696,75
SUBI-180-060	1837	600	633	454	280	335	1,23	600	7,7	14,4	2.039,29

① For special colours in categories 1 and 2, see "Special solutions" and "Colour chart"

③ Thermal output to EN 442, ΔT 50 K (75/65/20°C)

Zehnder Subway

Connection to hot water central heating system – Version for guest WC

Painted version

Model	H mm	L mm	Thermal output				Exp. n	Classification Electric heating element Watt	V dm ³	M kg	Price RAL 9016 €	Price ^① Cat. 1 €
			EN 442 ^③ W	70/55/24 W	55/45/24 W	55/45/20 W						
SUB-060-045	613	450	310	221	135	162	1,25	-	2,3	5,2	370,32	462,90

Chrome-plated version

Model	H mm	L mm	Thermal output				Exp. n	Classification Electric heating element Watt	V dm ³	M kg	Price Chrome €
			EN 442 ^③ W	70/55/24 W	55/45/24 W	55/45/20 W					
SUBC-060-045	613	450	205	145	88	106	1,27	-	2,3	5,0	776,48

Stainless-steel version

Model	H mm	L mm	Thermal output				Exp. n	Classification Electric heating element Watt	V dm ³	M kg	Price Stainless steel €
			EN 442 ^③ W	70/55/24 W	55/45/24 W	55/45/20 W					
SUBI-060-045	613	450	221	157	95	115	1,27	-	2,3	5,1	974,43

Connection for dual energy operation with integrated electric heating element¹⁾



Painted version

Model	H ^④ mm	L mm	Thermal output				Exp. n	Classification Electric heating element Watt	V dm ³	M kg	Price RAL 9016 €	Price ^① Cat. 1 €
			EN 442 ^③ W	70/55/24 W	55/45/24 W	55/45/20 W						
SUBM-130-45/GD	1291	450	509	363	222	267	1,25	500	4,5	8,6	1.031,00	1.185,64
SUBM-150-45/GD	1579	450	615	438	268	322	1,25	600	5,4	10,6	1.121,35	1.289,56
SUBM-180-45/GD	1867	450	715	511	314	377	1,24	600	6,3	12,2	1.299,32	1.494,22
SUBM-130-60/GD	1291	600	639	455	279	335	1,25	600	5,4	10,5	1.089,10	1.252,45
SUBM-150-60/GD	1579	600	772	550	337	405	1,25	750	7,2	12,5	1.227,62	1.411,76
SUBM-180-60/GD	1867	600	898	642	395	473	1,24	900	7,7	14,7	1.344,56	1.546,23

Chrome-plated version

Model	H ^④ mm	L mm	Thermal output				Exp. n	Classification Electric heating element Watt	V dm ³	M kg	Price Chrome €
			EN 442 ^③ W	70/55/24 W	55/45/24 W	55/45/20 W					
SUBMC-130-45/GD	1291	450	336	238	145	174	1,27	300	4,5	8,4	1.957,59
SUBMC-150-45/GD	1579	450	413	293	178	214	1,27	300	5,4	10,1	2.308,26
SUBMC-180-45/GD	1867	450	486	345	209	252	1,27	300	6,3	11,8	2.662,40
SUBMC-130-60/GD	1291	600	408	290	177	213	1,26	300	5,4	10,2	2.064,46
SUBMC-150-60/GD	1579	600	502	357	218	262	1,26	300	7,2	12,3	2.566,90
SUBMC-180-60/GD	1867	600	590	419	256	308	1,26	600	7,7	14,3	2.798,97

Stainless-steel version

Model	H ^④ mm	L mm	Thermal output				Exp. n	Classification Electric heating element Watt	V dm ³	M kg	Price Stainless steel €
			EN 442 ^③ W	70/55/24 W	55/45/24 W	55/45/20 W					
SUBMI-130-45/GD	1291	450	370	262	159	192	1,27	300	4,5	8,7	2.147,05
SUBMI-150-45/GD	1579	450	445	315	192	231	1,27	300	5,4	10,4	2.533,25
SUBMI-180-45/GD	1867	450	523	370	224	270	1,28	500	6,3	12,2	3.065,65
SUBMI-130-60/GD	1291	600	447	318	194	233	1,26	300	5,4	10,4	2.300,51
SUBMI-150-60/GD	1579	600	538	383	235	282	1,25	500	7,2	12,4	2.814,89
SUBMI-180-60/GD	1867	600	633	454	280	335	1,23	600	7,7	14,4	3.149,67

¹⁾ Maximum operating pressure for dual energy operation: 4 bar

^① For special colours in categories 1 and 2, see “Special solutions” and “Colour chart”

^③ Thermal output to EN 442, ΔT 50 K (75/65/20°C)

^④ Total height incl. electric heating element

For legend, see “Electric operation and Ecodesign Directive” on page 173

Zehnder Subway



Electric-only operation



Painted version

Model	H ^③	L	Classification Electric heating element Watt	Price	Price ^①
	mm			RAL 9016 €	Cat. 1 €
SUBE-130-45/GD	1291	450	500	1.006,32	1.157,28
SUBE-150-45/GD	1579	450	600	1.093,32	1.257,31
SUBE-180-45/GD	1867	450	750	1.299,32	1.494,22
SUBE-130-60/GD	1291	600	600	1.089,10	1.252,45
SUBE-150-60/GD	1579	600	750	1.198,02	1.377,72
SUBE-180-60/GD	1867	600	900	1.344,56	1.546,23

Chrome-plated version

Model	H ^③	L	Classification Electric heating element Watt	Price
	mm			Chrome €
SUBEC-130-45/GD	1291	450	300	1.909,72
SUBEC-150-45/GD	1579	450	300	2.252,26
SUBEC-180-45/GD	1867	450	300	2.662,40
SUBEC-130-60/GD	1291	600	300	2.064,46
SUBEC-150-60/GD	1579	600	300	2.504,31
SUBEC-180-60/GD	1867	600	600	2.729,68

Stainless-steel version

Model	H ^③	L	Classification Electric heating element Watt	Price
	mm			Stainless steel €
SUBEI-130-45/GD	1291	450	300	2.094,31
SUBEI-150-45/GD	1579	450	300	2.470,58
SUBEI-180-45/GD	1867	450	500	3.065,65
SUBEI-130-60/GD	1291	600	300	2.300,51
SUBEI-150-60/GD	1579	600	500	2.745,67
SUBEI-180-60/GD	1867	600	600	3.072,22

Standard scope of delivery for operation on hot water central heating system

- Powder coating to DIN 55900, RAL 9016
- 4 x ½" connections for flow, return, left-hand or right-hand electric heating element (on site)
- Dual energy operation: Electric heating element RACY-S, pre-assembled on the right, with remote control device, incl. batteries, with selectable operating modes: manual (above room temperature), weekly programme, timer, off. Electric heating element cover in colour of radiator
- ½" chrome directional air vent
- Mounting accessories in colour of radiator
- Packaging

Standard scope of delivery for electric operation

- Powder coating to DIN 55900, RAL 9016
- Filled with heat transfer fluid
- Electric heating element RACY-S with remote control device, incl. batteries, with selectable operating modes: manual (above room temperature), weekly programme, timer, off
- Mounting accessories and electric heating element control box cover in colour of radiator
- Packaging

Special solution on request (surcharge)	Article number	Price €
■ Special finish to category 2 (surcharge on cat. 1)	U100011640	146,76
■ Surface in metal look: stainless-steel look (reduced output approx. 8%)	U100012332	As in Cat. 1
■ Room divider version with two wall brackets and foot support, white, chrome, special colour	-	257,07
■ Room divider version with two wall brackets without foot support, white, chrome, special colour	-	199,02
■ Models for electric operation in room divider version	-	On request
■ Zehnder valves, lockshield valves and connection fittings	-	See p. 165 onwards
■ Connection from bottom to bottom, central, spacing 150 mm	U100062530	85,31

① For special colours in categories 1 and 2, see "Special solutions" and "Colour chart"

③ Total height incl. electric heating element

For legend, see "Electric operation and Ecodesign Directive" on page 173

Zehnder Subway

Operation on hot water central heating system:

Wall mounting
(with welded-on threaded bolts)

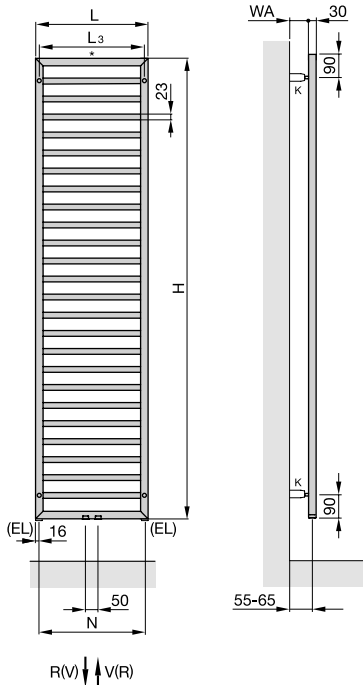

Room divider installation
(special solution without welded-on threaded bolts) ¹⁾

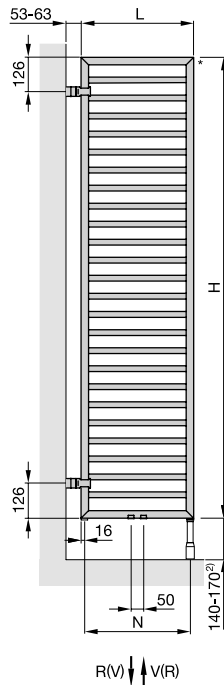

Electric operation:

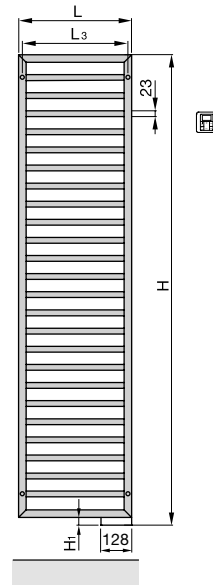

Dual energy operation:

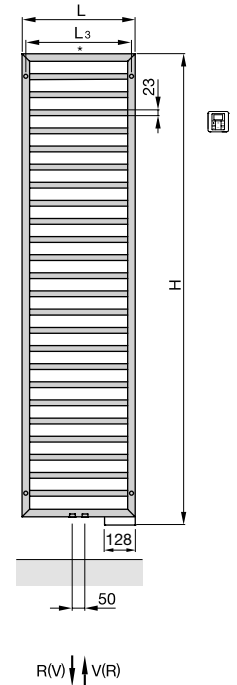

Operation on central heating system:

Version for guest WC

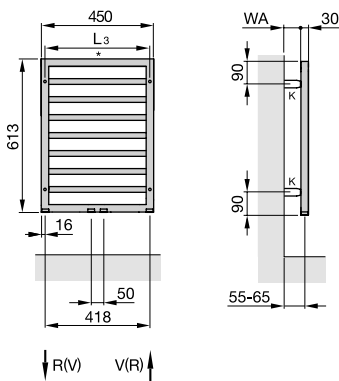

- H = Height
- H₁ = 30 mm
- L = Length
- EL = Connection for electric heating element
- K = Bracket
- V = Flow 1/2"
- R = Return 1/2"
- * = Venting 1/2"
- N = Connection centre
- WA = Wall clearance 40-50 mm
- L₃ = Fixing dimension, L - 30 mm

Dimensions in mm

- 1) The standard version of the radiator is not suitable for room divider installation
- 2) For installation with foot support in standard length

Zehnder Toga



Radiator surface: Chrome



Radiator colour: Beach Gold
Radiator colour: Traffic White

Operation on hot water central heating system

Zehnder Toga decorative radiator made from horizontally arranged precision steel tubes with vertical, fully welded D-profile tubes and invisible welds due to laser welding technology. Round tube Ø 23 mm, D-tube 30 x 35 mm.

Thermal output tested to EN 422, with CE marking.

Flow/return connection in centre ½" or outside left and right ½", connection 50 mm for connection fitting, connection for electric heating element 2 x ½" at bottom on D-profile tube; air vent to top ¼". Radiator with powder coating, in colour RAL 9016 as standard, in special colour on request.

Delivered ready to install with matching wall brackets, packaging.

Electric operation

Zehnder Toga designer radiator, electric-only, made from horizontally arranged precision steel tubes with vertical, fully welded D-profile tubes and invisible welds due to laser welding technology. With integrated electric heating element RACY-C, degree of protection IP44 (splash-proof), for mains power supply of 230 V. Connection cable (1,2 m) with Euro plug. Installation at bottom left. Decorative radiator filled with heat transfer fluid. Separate, battery-operated remote control device model 2 for controlling the room temperature.

Delivered ready to install with elegant wall brackets. Standard version with powder coating in colour RAL 9016, in special colour or chrome on request, with packaging.

Operating pressure	max. 11,5 bar
Operating temperature	max. 110°C
Height mm
Length mm
Model

Output Watt
Height mm
Length mm
Model

Benefits

- Harmonious design through D-profile of vertical tubes
- Can be used as a room divider
- Large cut-outs
- High output due to internal tube design
- Wide range of models
- Top-grade chrome finish

Special benefits for electric operation with RACY-C

- Remote control device can be positioned as required
- Regulated room temperature
- Comfortable operation as needed by customisable daily and weekly programmes
- Energy-efficient and comfortable heating via innovative open window detection
- Low energy consumption in stand-by mode (≤ 0,5 W)
- Keylock can be activated as required
- Timer function for up to 2 hours
- Ready-to-plug

Zehnder Toga

Overview of models

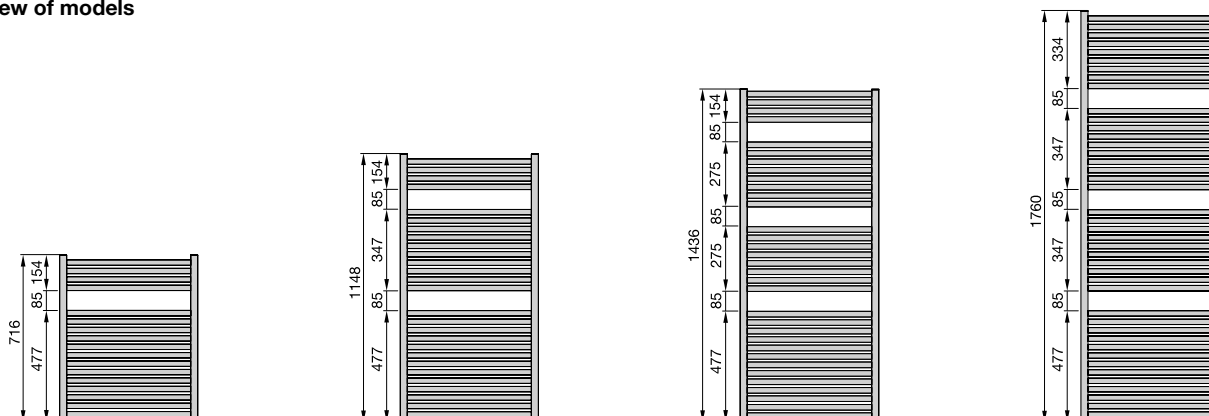

Connection to hot water central heating system or for dual energy operation¹⁾

Painted version, connection from below

Model	H mm	L mm	Thermal output				Exp. n	Classification Electric heating element Watt	V dm ³	M kg	Price RAL 9016 €	Price ^① Cat. 1 €
			EN 442 ^② Watt	70/55/24 Watt	55/45/24 Watt	55/45/20 Watt						
TG-070-045	716	450	347	249	154	184	1,20	300	3,4	6,2	272,06	340,07
TG-120-045	1148	450	539	385	237	284	1,22	300	5,5	9,7	331,79	414,74
TG-180-045	1760	450	823	588	362	434	1,25	600	8,4	16,3	463,19	578,98
TG-070-050	716	500	381	273	169	202	1,20	300	3,7	6,7	297,66	372,07
TG-120-050	1148	500	592	423	260	312	1,22	300	6,0	10,5	343,71	429,63
TG-150-050	1436	500	736	527	326	386	1,24	600	7,3	13,1	451,61	564,51
TG-180-050	1760	500	904	646	397	476	1,25	600	9,1	17,3	476,85	596,07
TG-070-060	716	600	449	323	200	239	1,20	300	4,3	7,8	331,79	414,74
TG-120-060	1148	600	696	497	306	367	1,22	600	6,9	12,0	357,40	446,75
TG-150-060	1436	600	866	621	383	454	1,24	600	8,5	14,8	477,42	596,78
TG-180-060	1760	600	1063	762	470	563	1,25	900	10,6	19,4	493,93	617,40
TG-120-075	1148	750	849	608	376	450	1,22	600	8,6	13,9	391,51	489,39
TG-180-075	1760	750	1297	932	578	690	1,24	1200	12,8	22,5	540,01	675,01
TG-180-100	1760	1000	1675	1210	756	901	1,22	1200	16,5	27,7	594,55	743,20

Painted version, connection central 50 mm

Model	H mm	L mm	Thermal output				Exp. n	Classification Electric heating element Watt	V dm ³	M kg	Price RAL 9016 €	Price ^① Cat. 1 €
			EN 442 ^② Watt	70/55/24 Watt	55/45/24 Watt	55/45/20 Watt						
TG-070-045-05	716	450	347	249	154	184	1,20	300	3,4	6,5	344,72	430,90
TG-120-045-05	1148	450	539	385	237	284	1,22	300	5,5	10,0	404,46	505,59
TG-180-045-05	1760	450	823	588	362	434	1,25	600	8,4	16,6	535,87	669,84
TG-070-050-05	716	500	381	273	169	202	1,20	300	3,7	7,0	370,32	462,90
TG-120-050-05	1148	500	592	423	260	312	1,22	300	6,0	10,8	416,41	520,51
TG-150-050-05	1436	500	736	527	326	386	1,24	600	7,3	13,4	515,41	644,27
TG-180-050-05	1760	500	904	646	397	476	1,25	600	9,1	17,6	549,51	686,89
TG-070-060-05	716	600	449	323	200	239	1,20	300	4,3	8,1	404,46	505,59
TG-120-060-05	1148	600	696	497	306	367	1,22	600	6,9	12,3	430,07	537,60
TG-150-060-05	1436	600	866	621	383	454	1,24	600	8,5	15,1	530,75	663,44
TG-180-060-05	1760	600	1063	762	470	563	1,25	900	10,6	19,7	566,55	708,19
TG-120-075-05	1148	750	849	608	376	450	1,22	600	8,6	14,2	464,21	580,25
TG-180-075-05	1760	750	1297	932	578	690	1,24	1200	12,8	22,8	612,65	765,82
TG-180-100-05	1760	1000	1675	1210	756	901	1,22	1200	16,5	28,0	667,27	834,09

¹⁾ Maximum operating pressure for dual energy operation: 4 bar

^① For special colours in categories 1 and 2, see "Special solutions" and "Colour chart"

^② Thermal output measured according to EN 442, ΔT 50 K (75/65/20 °C)

Connection to hot water central heating system or for dual energy operation¹⁾

Chrome-plated version, connection from bottom

Model	H	L	Thermal output			Exp.	Classification	V	M	Price Chrome
			EN 442 ²⁾	70/55/24	55/45/24					
	mm	mm	Watt	Watt	Watt	n	Watt	dm ³	kg	€
TGC-070-050	716	500	240	169	101	1,30	300	3,7	6,7	968,92
TGC-120-050	1148	500	379	267	160	1,30	300	5,8	10,5	1.142,02
TGC-150-050	1436	500	478	335	201	1,31	300	7,4	13,1	1.380,89
TGC-180-050	1760	500	596	419	252	1,30	300	9,3	17,3	1.508,17
TGC-120-060	1148	600	451	317	190	1,30	300	6,9	12,0	1.224,13
TGC-180-060	1760	600	709	499	299	1,30	600	10,8	19,4	1.615,42

Electric-only operation

Painted version

Model	H ³⁾	L	Classification	Price	
				Price RAL 9016	Price ¹⁾
	mm	mm	Electric heating element	€	Cat. 1
			Watt	€	€
TE-070-050/GD	741	500	300	713,35	820,36
TE-120-050/GD	1173	500	600	846,45	973,42
TE-150-050/GD	1461	500	750	996,63	1.146,13
TE-180-050/GD	1785	500	900	1.090,49	1.254,06
TE-120-060/GD	1173	600	600	872,06	1.002,87
TE-180-060/GD	1785	600	1200	1.138,27	1.309,03
TE-180-075/GD	1785	750	1500	1.274,78	1.466,00

Chrome-plated version

Model	H ³⁾	L	Classification	Price
				Chrome
	mm	mm	Electric heating element	€
			Watt	€
TEC-120-050/GD	1173	500	300	1.836,28
TEC-150-050/GD	1461	500	500	2.177,59
TEC-180-060/GD	1785	600	750	2.467,72

Standard scope of delivery for operation on hot water central heating system

- Powder coating to DIN 55900, RAL 9016
- 2 x ½" connections for flow, return
- Retrofit model: 2 x ½" at side, 1 x ½" at bottom
- ¼" directional air vent, right
- Mounting accessories in colour of radiator
- Packaging

Standard scope of delivery for electric operation

- Powder coating to DIN 55900, RAL 9016
- Filled with heat transfer fluid
- With integrated electric heating element RACY-C, bottom left, with remote control device, incl. battery, with selectable operating modes: manual (above room temperature), weekly programme, timer, off
- Electric heating element cover in colour of radiator
- Mounting accessories in colour of radiator
- Packaging

Special solution on request (surcharge)	Article number	Price €
■ Special finish to category 2 (surcharge on cat. 1)	2800011640	146,76
■ Surface in metal look: stainless-steel look (reduced output approx. 13%)	2800012332	As in Cat. 1
■ Use as room divider with separate mounting accessories	-	See page 151
■ Retrofit model with optional lateral connections (same side or opposite-end)	-	186,33
■ Electric heating element and T-piece for dual energy operation	-	See p. 161 onwards
■ Accessories	-	See page 160
■ Lambswool cleaning brush	601040	60,41
■ Zehnder valves, lockshield valves and connection fittings	-	See p. 165 onwards
■ Wall mounting accessories for extended wall clearance up to 130 mm, white	952021	117,37

¹⁾ For special colours in categories 1 and 2, see "Special solutions" and "Colour chart"

²⁾ Thermal output to EN 442, ΔT 50 K (75/65/20°C)

³⁾ Total height incl. electric heating element

For legend, see "Electric operation and Ecodesign Directive" on page 173

Zehnder Toga

Operation on hot water central heating system:
Wall mounting

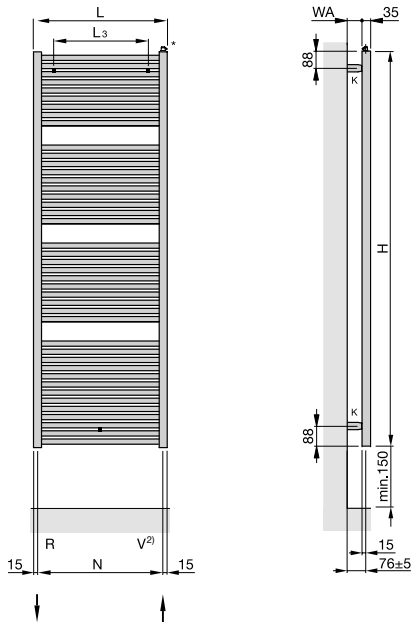

Room divider installation,
with 50 mm centre connection

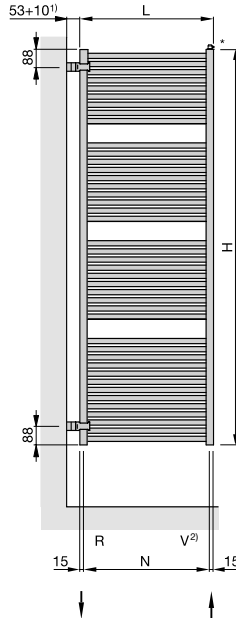

Retrofit model,
connections left

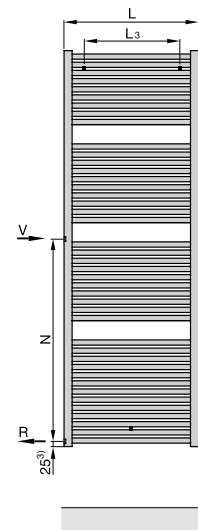

Electric operation:

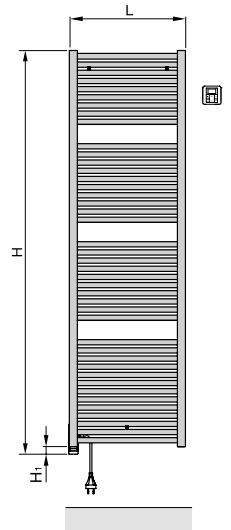

Dual energy operation:

Connection to hot water central heating system with electric heating element (fig. with RICA) and T-piece in return

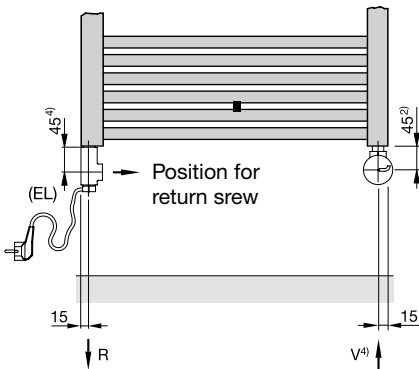

- H = Height
- H₁ = 25 mm
- L = Length
- EL = Connection for electric heating element
- K = Bracket
- V = Flow 1/2"
- R = Return 1/2"
- * = Venting 1/4"
- N = Connection centre
- L₃ = Fixing dimension, L - 150 mm
- WA = Wall clearance 55–65 mm

Dimensions in mm

- 1) Extension to 103 mm possible with room divider brackets for larger wall clearance, see page 146
- 2) Replacement of flow/return when changing immersion tube from right to left is possible
- 3) At connection size/connection centre on request, return connection 34 mm from lower edge
- 4) For electric heating element DBM 20 mm

Zehnder Forma Asym



Radiator colour: Traffic White

Operation on hot water central heating system

Zehnder Forma Asym decorative radiator made from horizontally arranged precision steel tubes welded to vertically arranged round tubes. Invisible connection due to capstan welding technology. Horizontal tubes each branch asymmetrically from the laterally arranged manifolds. Horizontal steel tubes Ø 25 mm, vertical header tubes Ø 38 mm.

Thermal output tested to EN 442, with CE marking.

With connections at bottom, 2 x ½" for flow/return, connection centre 50 mm. Alternatively with additional 2 x ½" centre connections, spacing 50 mm for flow/return. Radiator with powder coating, in colour RAL 9016 as standard, in special colour on request. Delivered ready to install with elegant wall brackets.

Operating pressure	max. 10 bar
Operating temperature	max. 95°C
Height mm
Length mm
Model

Benefits

- Cross-connected tubes lend relaxed look
- Open access from both sides makes it very convenient for hanging and sliding towels in from the side
- Large wall clearance for snugly warm towels
- Diverse range of models with left-hand or right-hand version
- Dual energy operation possible with centre connections as an option

Electric operation

Zehnder Forma Asym decorative radiator as multifunctional bathroom heater, electric-only, made from horizontally arranged precision steel tubes welded to vertically arranged round tubes with invisible welds due to capstan welding technology. Horizontal steel tubes Ø 25 mm, vertical header tubes Ø 38 mm.

With integrated electric heating element RACY-C, degree of protection IP44 (splash-proof), for mains power supply of 230 V. Connection cable (1,2 m) with Schuko plug. Decorative radiator filled with heat transfer fluid. Separate, battery-operated remote control device model 2 for controlling the room temperature.

Delivered ready to install with elegant wall brackets. Standard version with powder coating, in colour RAL 9016, in special colour on request.

Output Watt
Height mm
Length mm
Model

Special benefits for electric operation with RACY-C

- Remote control device can be positioned as required
- Regulated room temperature
- Comfortable operation as needed by customisable daily and weekly programmes
- Energy-efficient and comfortable heating via innovative open window detection
- Low energy consumption in stand-by mode (≤ 0,5 W)
- Keylock can be activated as required
- Timer function for up to 2 hours
- Ready-to-plug

Zehnder Forma Asym

Overview of models:

Right-hand version

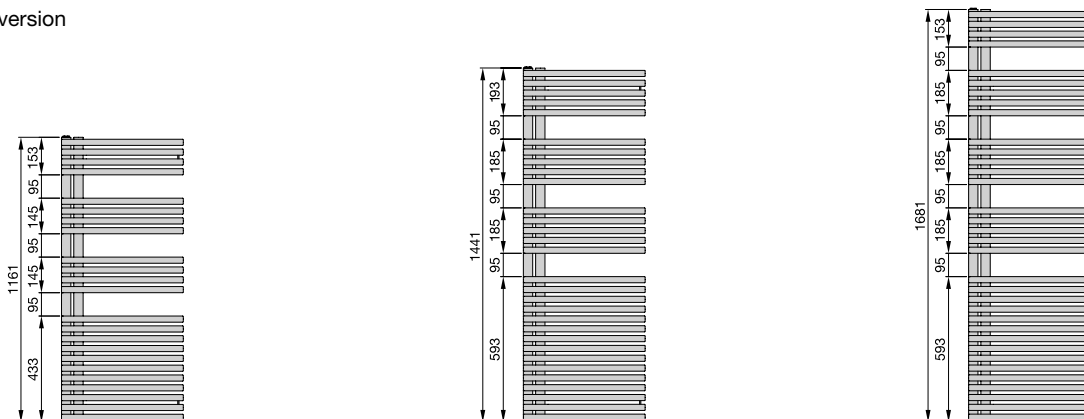

Connection to hot water central heating system

Painted version

Model	H mm	L mm	Thermal output				Exp. n	Classification Electric heating element Watt	V dm ³	M kg	Price RAL 9016 €	Price ^① Cat. 1 €
			EN 442 ^③ W	70/55/24 W	55/45/24 W	55/45/20 W						
Right-hand version												
LFAR-120-050	1161	496	547	389	237	285	1,26	-	7,0	12,1	679,41	849,26
LFAR-150-050	1441	496	672	475	288	347	1,28	-	8,8	15,0	817,74	1.022,18
LFAR-170-050	1681	496	778	552	335	404	1,27	-	10,1	17,1	909,98	1.137,48
LFAR-120-060	1161	596	628	446	272	327	1,26	-	8,0	13,8	713,22	891,52
LFAR-150-060	1441	596	772	544	328	396	1,29	-	10,0	17,2	857,11	1.071,37
LFAR-170-060	1681	596	894	634	385	464	1,27	-	11,4	19,6	953,01	1.191,27
Left-hand version												
LFAL-120-050	1161	496	547	389	237	285	1,26	-	7,0	12,1	679,41	849,26
LFAL-150-050	1441	496	672	475	288	347	1,28	-	8,8	15,0	817,74	1.022,18
LFAL-170-050	1681	496	778	552	335	404	1,27	-	10,1	17,1	909,98	1.137,48
LFAL-120-060	1161	596	628	446	272	327	1,26	-	8,0	13,8	713,22	891,52
LFAL-150-060	1441	596	772	544	328	396	1,29	-	10,0	17,2	857,11	1.071,37
LFAL-170-060	1681	596	894	634	385	464	1,27	-	11,4	19,6	953,01	1.191,27

Connection to hot water central heating system with 50 mm centre connections

Painted version

Model	H mm	L mm	Thermal output				Exp. n	Classification Electric heating element Watt	V dm ³	M kg	Price RAL 9016 €	Price ^① Cat. 1 €
			EN 442 ^③ W	70/55/24 W	55/45/24 W	55/45/20 W						
Right-hand version												
LFAR-120-050-05	1161	496	547	389	237	285	1,26	300	7,0	12,1	767,60	959,50
LFAR-150-050-05	1441	496	672	475	288	347	1,28	600	8,8	15,0	909,83	1.137,30
LFAR-170-050-05	1681	496	778	552	335	404	1,27	600	10,1	17,1	1.004,65	1.255,80
LFAR-120-060-05	1161	596	628	446	272	327	1,26	600	8,0	13,8	802,37	1.002,96
LFAR-150-060-05	1441	596	772	544	328	396	1,29	600	10,0	17,2	950,28	1.187,85
LFAR-170-060-05	1681	596	894	634	385	464	1,27	900	11,4	19,6	1.048,90	1.311,12
Left-hand version												
LFAL-120-050-05	1161	496	547	389	237	285	1,26	300	7,0	12,1	767,60	959,50
LFAL-150-050-05	1441	496	672	475	288	347	1,28	600	8,8	15,0	909,83	1.137,30
LFAL-170-050-05	1681	496	778	552	335	404	1,27	600	10,1	17,1	1.004,65	1.255,80
LFAL-120-060-05	1161	596	628	446	272	327	1,26	600	8,0	13,8	802,37	1.002,96
LFAL-150-060-05	1441	596	772	544	328	396	1,29	600	10,0	17,2	950,28	1.187,85
LFAL-170-060-05	1681	596	894	634	385	464	1,27	900	11,4	19,6	1.048,90	1.311,12

① For special colours in categories 1 and 2, see "Special solutions" and "Colour chart"
 ③ Thermal output according to EN 442, ΔT 50 K (75/65/20°C)

Zehnder Forma Asym



Electric-only operation



Painted version

Model	H ^③	L	Classification Electric heating element Watt	Price	Price ^①
	mm	mm		RAL 9016 €	Cat. 1 €

Right-hand version

LFAER-120-50/GD	1186	496	500	1.046,78	1.203,80
LFAER-150-50/GD	1466	496	600	1.229,38	1.413,79
LFAER-170-50/GD	1706	496	750	1.351,13	1.553,79
LFAER-120-60/GD	1186	596	600	1.095,97	1.260,36
LFAER-150-60/GD	1466	596	750	1.288,74	1.482,05
LFAER-170-60/GD	1706	596	900	1.417,25	1.629,85

Left-hand version

LFAEL-120-50/GD	1186	496	500	1.046,78	1.203,80
LFAEL-150-50/GD	1466	496	600	1.229,38	1.413,79
LFAEL-170-50/GD	1706	496	750	1.351,13	1.553,79
LFAEL-120-60/GD	1186	596	600	1.095,97	1.260,36
LFAEL-150-60/GD	1466	596	750	1.288,74	1.482,05
LFAEL-170-60/GD	1706	596	900	1.417,25	1.629,85

Standard scope of delivery for operation on hot water central heating system

- Powder coating to DIN 55900, RAL 9016
- 2 x ½" connections for flow, return
- ½" directional air vent
- Mounting accessories in colour of radiator
- Packaging

Standard scope of delivery for electric operation

- Powder coating to DIN 55900, RAL 9016
- Filled with non-flammable heat-transfer fluid (frost-proof to -10°C)
- With integrated electric heating element RACY-C, bottom left or right, with remote control device, incl. battery, with selectable operating modes: manual (above room temperature), weekly programme, timer, off
- Electric heating element cover in colour of radiator
- Mounting accessories in colour of radiator
- Packaging

Special solution on request (surcharge)	Article number	Price €
■ Special finish to category 2 (surcharge on cat. 1)	7600011640	146,76
■ Surface in metal look: stainless-steel look (reduced output approx. 13%)	7600012332	As in Cat. 1
■ Electric heating element for dual energy operation ¹⁾	-	See p. 161 onwards
■ Zehnder thermostat LH2, M 30 x 1,5, white	819140	35,02
■ Zehnder thermostat LH2, M 30 x 1,5, chrome	819148	60,35
■ Zehnder valves, lockshield valves and connection fittings	-	See p. 165 onwards

1) Maximum operating pressure for dual energy operation: 4 bar

① For special colours in categories 1 and 2, see "Special solutions" and "Colour chart"

③ Total height incl. electric heating element

For legend, see "Electric operation and Ecodesign Directive" on page 173

Zehnder Forma Asym

Operation on hot water central heating system:

Wall mounting
Right-hand version

50 mm centre connections
Left-hand version

Electric operation:

Left-hand version

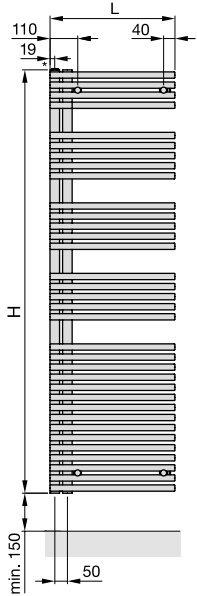

R(V) ↓ ↑ V(R)

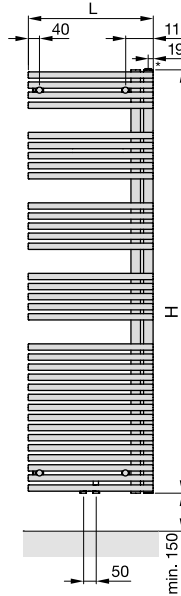

R(V) ↓ ↑ V(R)

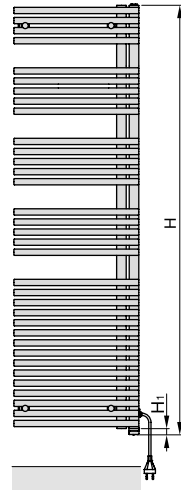
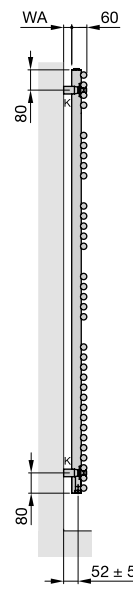

Dual energy operation:

Connection to hot water central heating system with 50 mm centre connections¹⁾ (with electric heating element DBM)

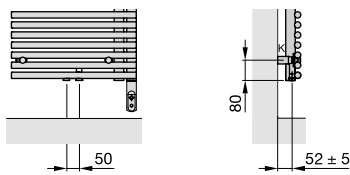

V(R) ↓ ↑ R(V)

H = Height

H₁ = 25 mm

L = Length

K = Bracket

WA = Wall clearance

Operation on central heating system = 27 ± 5 mm

Electric operation = 50 ± 5 mm

V = Flow 1/2"

R = Return 1/2"

* = Venting 1/2"

Dimensions in mm

¹⁾ Maximum operating pressure for dual energy operation: 4 bar

Zehnder Forma Spa



Radiator colour: Beige Quartz

Operation on hot water central heating system

Zehnder Forma Spa decorative radiator made from horizontally arranged precision steel tubes welded to vertically arranged round tubes. Invisible connection due to capstan welding technology. Single or double-layer version. Horizontal steel tubes Ø 25 mm, vertical header tubes Ø 38 mm. Thermal output tested to EN 442, with CE marking. With centre connections, 1/2" for flow/return, connection centre 50 mm and outside left and right, 1/2" for electric heating element, with directional air vent. Radiator with powder coating, in colour RAL 9016 as standard, in special colour or chrome on request; with packaging. Delivered ready to install with elegant wall brackets.

Electric operation

Zehnder Forma Spa decorative radiator as multifunctional bathroom heater, electric-only, made from horizontally arranged precision steel tubes welded to vertically arranged round tubes with invisible welds due to capstan welding technology. Horizontal steel tubes Ø 25 mm, vertical header tubes Ø 38 mm. With integrated electric heating element RACY-C, degree of protection IP44 (splash-proof), for mains power supply of 230 V. Connection cable (1,2 m) with Schuko plug. Installation at bottom right. Decorative radiator filled with heat transfer fluid. Separate, battery-operated remote control device model 2 for controlling the room temperature. Delivered ready to install with elegant wall brackets. Standard version with powder coating, in colour RAL 9016, in special colour or chrome on request.

Operating pressure	max. 10 bar
Operating temperature	max. 110°C
Height mm
Length mm
Model

Output Watt
Height mm
Length mm
Model

Benefits

- Cross-connected tubes lend relaxed look
- Double-layer models for high thermal output
- Large wall clearance for snugly warm towels
- Centre connections
- Available with matching connection fittings
- Dual energy operation possible without T-piece

Special benefits for electric operation with RACY-C

- Remote control device can be positioned as required
- Regulated room temperature
- Comfortable operation as needed by customisable daily and weekly programmes
- Energy-efficient and comfortable heating via innovative open window detection
- Low energy consumption in stand-by mode (≤ 0,5 W)
- Keylock can be activated as required
- Timer function for up to 2 hours
- Ready-to-plug

Zehnder Forma Spa

Overview of models

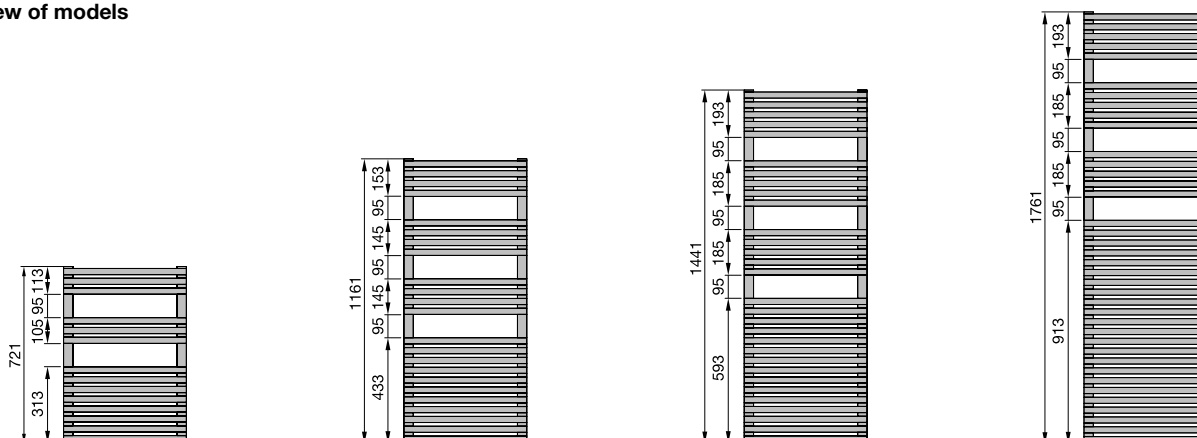

Connection to hot water central heating system or for dual energy operation¹⁾

Painted version

Model	H mm	L mm	Thermal output				Exp. n	Classification Electric heating element Watt	V dm ³	M kg	Price RAL 9016 €	Price [ⓐ] Cat. 1 €
			EN 442 [ⓑ] Watt	70/55/24 Watt	55/45/24 Watt	55/45/20 Watt						
Single-layer version, connection central 50 mm												
LF-070-050-05	721	496	378	270	166	199	1,24	300	4,2	7,4	558,08	697,60
LF-120-050-05	1161	496	612	437	269	322	1,24	600	6,8	12,1	609,26	761,57
LF-150-050-05	1441	496	796	570	352	422	1,23	600	8,7	15,6	667,27	834,09
LF-180-050-05	1761	496	973	699	433	518	1,22	900	10,9	19,6	815,75	1.019,69
LF-070-060-05	721	596	442	318	197	235	1,22	300	4,7	8,5	575,12	718,91
LF-120-060-05	1161	596	707	508	315	376	1,22	600	7,7	13,9	639,98	799,97
LF-150-060-05	1441	596	927	668	416	496	1,21	900	9,9	18,0	756,02	945,03
LF-180-060-05	1761	596	1133	814	505	603	1,22	900	12,5	22,6	855,01	1.068,77
LF-180-075-05	1761	746	1416	1018	631	754	1,22	1200	14,8	26,8	923,26	1.154,08

Double-layer version, connection central 50 mm

LFD-120-050-05	1161	496	855	604	370	444	1,25	-	10,8	19,9	1.066,61	1.333,27
LFD-150-050-05	1441	496	1065	776	474	569	1,26	-	14,3	26,3	1.172,41	1.465,51
LFD-180-050-05	1761	496	1298	923	563	677	1,26	-	17,9	32,6	1.262,85	1.578,56
LFD-120-060-05	1161	596	1017	721	442	530	1,25	-	12,6	23,1	1.052,97	1.316,22
LFD-180-060-05	1761	596	1543	1091	666	800	1,26	-	20,8	38,0	1.293,59	1.616,99

Painted version

Model	H mm	L mm	Thermal output				Exp. n	Classification Electric heating element Watt	V dm ³	M kg	Price RAL 9016 €	Price [ⓐ] Cat. 1 €
			EN 442 [ⓑ] Watt	70/55/24 Watt	55/45/24 Watt	55/45/20 Watt						
Single-layered version, connection from bottom												
LF-070-050	721	496	378	270	166	199	1,24	300	4,2	7,0	469,23	586,54
LF-120-050	1161	496	612	437	269	322	1,24	300	6,8	12,1	520,43	650,53
LF-150-050	1441	496	796	422	352	422	1,24	600	8,8	15,7	634,21	792,76
LF-180-050	1761	496	973	699	433	518	1,24	900	11,0	19,6	726,92	908,64
LF-070-060	721	596	442	318	197	235	1,23	300	4,7	8,5	486,30	607,88
LF-120-060	1161	596	707	508	315	376	1,24	600	7,8	14,0	551,16	688,94
LF-150-060	1441	596	927	668	416	496	1,24	900	10,0	18,0	667,19	833,99
LF-180-060	1761	596	1133	814	505	603	1,24	900	12,5	22,6	766,18	957,73
LF-180-075	1761	746	1416	1018	631	754	1,24	1200	14,8	27,1	834,42	1.043,03

Double-layered version, connection from bottom

LFD-120-050	1161	496	855	604	370	444	1,25	-	10,8	19,9	977,80	1.222,24
LFD-150-050	1441	496	1065	776	474	569	1,26	-	14,3	26,3	1.083,59	1.354,48
LFD-180-050	1761	496	1285	923	563	677	1,26	-	17,9	32,6	1.174,05	1.467,57
LFD-120-060	1161	596	1017	721	442	530	1,25	-	12,6	23,1	964,14	1.205,18
LFD-180-060	1761	596	1543	1091	666	800	1,26	-	20,8	38,0	1.204,76	1.505,96

[ⓐ] For special colours in categories 1 and 2, see "Special solutions" and "Colour chart"

[ⓑ] Thermal output to EN 442, ΔT 50 K (75/65/20°C)

Zehnder Forma Spa



Chrome-plated version, connection central 50 mm

Model	H mm	L mm	Thermal output				Exp. n	Classification Electric heating element Watt	V dm ³	M kg	Price Chrome €
			EN 442 ^③ Watt	70/55/24 Watt	55/45/24 Watt	55/45/20 Watt					
LFC-070-050-05	721	496	254	181	111	133	1,28	300	4,2	7,4	1.134,87
LFC-120-050-05	1161	496	402	283	170	205	1,30	300	6,8	12,1	1.218,49
LFC-150-050-05	1441	496	512	362	219	264	1,25	300	8,7	15,6	1.438,66
LFC-180-050-05	1761	496	636	447	269	325	1,29	600	10,9	19,6	1.717,62
LFC-120-060-05	1161	596	464	333	207	247	1,25	300	7,7	13,9	1.285,04
LFC-180-060-05	1761	596	744	522	312	378	1,29	600	12,4	22,6	1.694,61

Chrome-plated version, connection from bottom

Model	H mm	L mm	Thermal output				Exp. n	Classification Electric heating element Watt	V dm ³	M kg	Price Chrome €
			EN 442 ^③ Watt	70/55/24 Watt	55/45/24 Watt	55/45/20 Watt					
LFC-070-050	721	496	254	181	110	132	1,24	300	4,2	7,4	1.046,05
LFC-120-050	1161	496	402	283	170	205	1,24	300	6,8	12,1	1.129,68
LFC-150-050	1441	496	512	362	219	264	1,25	300	8,8	15,7	1.349,84
LFC-180-050	1761	496	636	447	269	325	1,24	600	11,0	19,6	1.628,80
LFC-120-060	1161	596	516	371	230	275	1,25	300	7,8	14,0	1.196,23

Connection to hot water central heating & open heating system or for dual energy operation¹⁾

Stainless steel version, connection from bottom - adaptable to open heating systems

Model	H mm	L mm	Thermal output				Exp. n	Classification Electric heating element Watt	V dm ³	M kg	Price Stainless steel €
			EN 442 ^③ Watt	70/55/24 Watt	55/45/24 Watt	55/45/20 Watt					
LFI-070-050	721	496	267	190	116	140	1,25	-	4,3	6,3	1.246,17
LFI-120-050	1161	496	430	305	159	224	1,26	300	6,9	10,5	1.482,66
LFI-150-050	1441	496	546	386	233	282	1,28	600	8,9	13,5	1.755,55
LFI-180-050	1761	496	683	482	292	352	1,28	600	11,1	16,9	2.092,09
LFI-120-060	1161	596	493	350	213	257	1,26	300	7,9	12,0	1.682,76

Electric-only operation



Painted version

Model	H ^③ mm	L mm	Classification Electric heating element Watt	Price	Price ^①
				RAL 9016 €	Cat. 1 €
LFE-070-050/GD	746	496	300	820,85	943,98
LFE-120-050/GD	1186	496	500	971,06	1.116,71
LFE-180-050/GD	1786	496	900	1.250,92	1.438,55
LFE-120-060/GD	1186	596	600	1.017,12	1.169,69
LFE-180-060/GD	1786	596	900	1.312,36	1.509,23

Chrome-plated version

Model	H ^③ mm	L mm	Classification Electric heating element Watt	Price
				Chrome €
LFEC-120-050/GD	1186	496	300	2.111,04
LFEC-180-050/GD	1786	496	600	2.716,86

Standard scope of delivery for operation on hot water central heating system

- Powder coating to DIN 55900, RAL 9016
- 4 x ½" connections for flow, return, electric heating element
- ½" directional air vent
- Mounting accessories in colour of radiator
- Packaging

Standard scope of delivery for electric operation

- Powder coating to DIN 55900, RAL 9016
- Filled with heat transfer fluid
- With integrated electric heating element RACY-C, bottom right, with remote control device, incl. battery, with selectable operating modes: manual (above room temperature), weekly programme, timer, off
- Mounting accessories in colour of radiator
- Packaging

¹⁾ Maximum operating pressure for dual energy operation: 4 bar^① For special colours in categories 1 and 2, see "Special solutions" and "Colour chart"^③ Total height incl. electric heating elementFor legend, see "Electric operation and Ecodesign Directive" on page 173  

Special solution on request (surcharge)	Article number	Price €
■ Special finish to category 2 (surcharge on cat. 1)	7600011640	146,76
■ Surface in metal look: stainless-steel look (reduced output approx. 13%)	7600012332	As in Cat. 1
■ Electric heating element for dual energy operation	-	See p. 161 onwards
■ Zehnder valves, lockshield valves and connection fittings	-	See p. 165 onwards

Operation on hot water central heating system:
Wall mounting
Single-layer

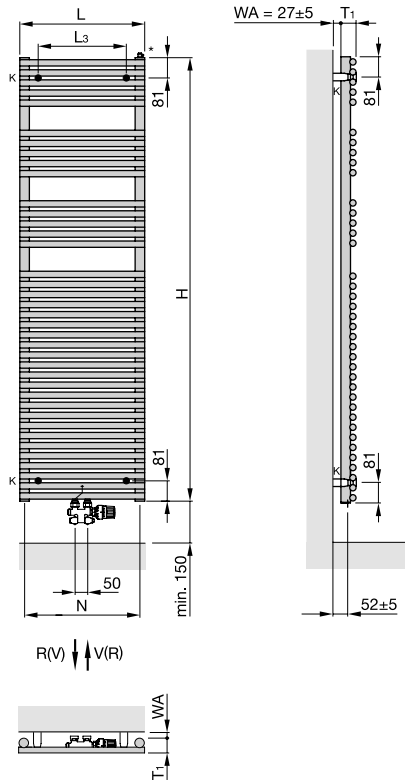

Wall mounting
Double-layered

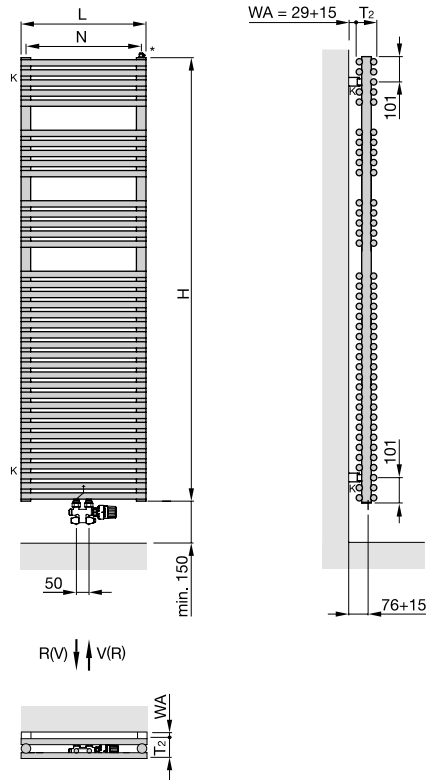

Electric operation:

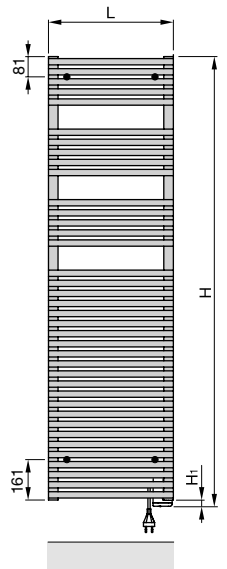

Dual energy operation:

Connection to hot water central heating system with electric heating element (fig. with DBM)

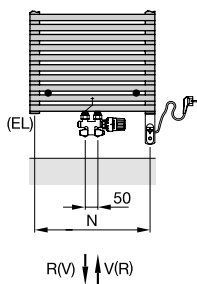

- H = Height
- H₁ = 25 mm
- L = Length
- T₁ = Depth 60 mm
- T₂ = Depth 82 mm
- K = Bracket
- WA = Wall clearance
Operation on central heating system = see drawing
Electric operation = 50±5 mm
- V = Flow 1/2"
- R = Return 1/2"
- * = Venting 1/2" / blanking plugs 1/2"
- EL = Connection for electric heating element
- N = Connection centre, L - 38 mm
- L₃ = Fixing dimension, L - 150 mm

Dimensions in mm

Zehnder Fina Lean Bar



Radiator surface: Cream

Operation on central heating system

Zehnder Fina Lean Bar decorative radiator with smooth front panel made of sheet steel in elegant and slim design, even surface and rounded sides for mounting desired towel rails. One towel rail included in scope of delivery. Heat output according to EN 442, with CE marking. With 2 x 1/2" female thread connection for flow/return at bottom centre, spacing 50 mm, air vent 1/2" at top in back. Radiator with powder coating, in colour RAL 9016 as standard, in special colour on request. Delivered ready to install with wall brackets and packaging.

Operating pressure	max. 6,0 bar
Operating temperature	max. 110 °C
Height mm
Length mm
Model

Benefits

- Slim, elegant design
- Easy to clean due to smooth surface
- Convenient hanging of towels with height-adjustable towel rail in chrome
- Optional: additional towel rail for hanging up more towels
- Pleasant warmth due to high proportion of radiation

Electric-only operation

Zehnder Fina Lean Bar decorative radiator with smooth front panel made of sheet steel in elegant and slim design, even surface and rounded sides for mounting desired towel rails. One towel rail included in scope of delivery. Radiator with sheet steel on the back side, an inside heating wire and a graphite plate between heating wire and front for even and fast heat distribution. With CE marking. Separate, battery-operated remote control device model 2, heating element RACY-S without visible control components on the radiator. Splash-proof IP44, mains connection 230 V. Connection cable 1.2 m long with Schuko plug. Radiator with powder coating, in colour RAL 9016 as standard, in special colour on request. Delivered ready to install with wall brackets and packaging.

Standard scope of delivery for operation on central heating system

- Powder coating to DIN 55900, RAL 9016
- Towel rail in chrome
- 2 x 1/2" connections at bottom, centric 50 mm
- 1/2" air vent
- Mounting accessories in colour of radiator
- Packaging

Special advantages for electric operation RACY-S

- Aesthetically appealing design due to concealed electric heating element
- Flexible control options: control device for wall mounting or base.
- Diverse adjustment options: Regulated room temperature or operation in energy-saving or frost-protection mode
- Customizable daily and weekly programmed for convenient, on-demand operation
- Energy-efficient and comfortable heating with innovative open window detection
- Low energy consumption of only 0.5 W in stand-by mode for increased energy efficiency
- Timer function for on-demand operation. Ready-to-plug for easy and quick installation

Zehnder Fina Lean Bar

Overview of models

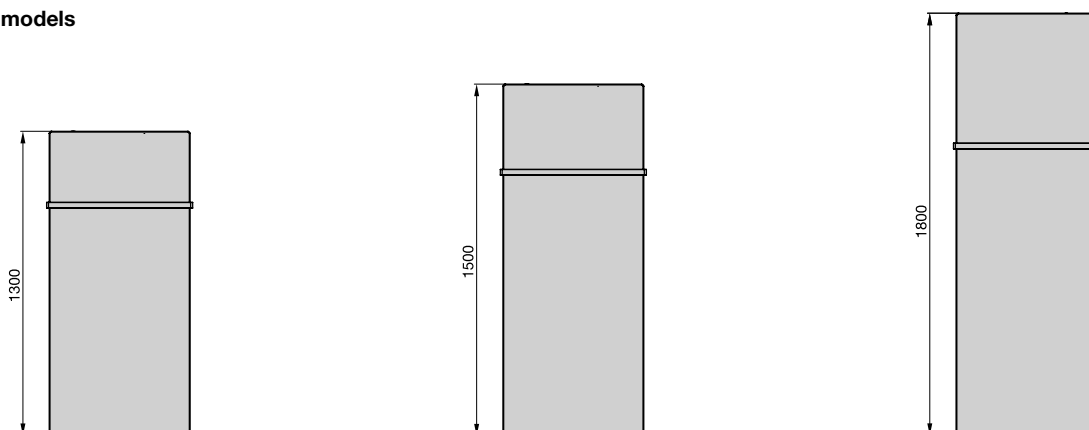

Connection to hot water central heating system

Painted version

Model	H mm	L mm	Thermal output				Exp. n	Output electric Watt	V dm ³	M kg	Price RAL 9016 €	Price ^① Cat. 1 €
			EN 442 ② Watt	70/55/24 Watt	55/45/24 Watt	55/45/20 Watt						
FIF-130-050	1300	500	620	444	274	328	1,23	-	0,90	20,9	942,39	1.177,99
FIF-150-050	1500	500	717	516	321	383	1,21	-	1,10	23,7	969,51	1.211,89
FIF-180-050	1800	500	863	619	382	458	1,23	-	1,30	28,7	1.010,18	1.262,73
FIF-130-060	1300	600	723	519	321	384	1,23	-	1,20	24,7	969,51	1.211,89
FIF-150-060	1500	600	837	600	371	444	1,23	-	1,40	28,3	996,63	1.245,79
FIF-180-060	1800	600	1008	719	441	529	1,25	-	1,50	31,4	1.044,08	1.305,10
FIF-130-070	1300	700	824	592	367	439	1,22	-	1,50	28,5	1.023,75	1.279,70
FIF-150-070	1500	700	954	682	420	503	1,24	-	1,70	32,9	1.057,65	1.322,06
FIF-180-070	1800	700	1148	814	495	596	1,27	-	1,80	39,6	1.105,11	1.381,38

Electric-only operation

Painted version



Model	H mm	L mm	Output electric Watt	Price RAL 9016 €	Price ^① Cat. 1 €
FIFE-130-050/D	1300	500	350	1.328,84	1.528,16
FIFE-150-050/D	1500	500	500	1.450,88	1.668,50
FIFE-180-050/D	1800	500	500	1.600,03	1.840,03
FIFE-180-060/D	1800	600	750	1.735,62	1.995,96
FIFE-180-070/D	1800	700	750	1.884,78	2.167,50

Standard scope of delivery for operation on hot water heating system

- Powder coating to DIN 55900, RAL 9016
- Towel rail in chrome plated
- 2 x 1/2" connections, bottom center 50 mm
- 1 x 1/2" air vent
- Mounting accessories in colour of radiator
- Packaging

Standard scope of delivery for electric operation

- Powder coating to DIN 55900, RAL 9016
- Remote control device, incl. battery, with selectable operating modes: manual (above room temperature), weekly programme, timer, off
- Towel rail in chrome plated
- Mounting accessories in colour of radiator
- Packaging

Special solution on request (surcharge)	Article number	Price €
■ Special finish to category 2 (surcharge on cat. 1)	FI00011640	146,76
■ Towel rail in chrome for radiator length 500 mm	481408	162,72
■ Towel rail in chrome for radiator length 600 mm	481418	169,48
■ Towel rail in chrome for radiator length 700 mm	481428	176,27
■ Zehnder thermostats	-	See page 164
■ Zehnder valves, return screw connections and connection fittings	-	See p. 165 onwards

① For special colours in categories 1 and 2, see special solutions and colour chart

② Thermal output to EN 442, ΔT 50 K (75/65/20 °C)

Zehnder Fina Lean Bar



Operation on central heating system: Wall mounting

Back side

Electric operation: Wall mounting

Back side

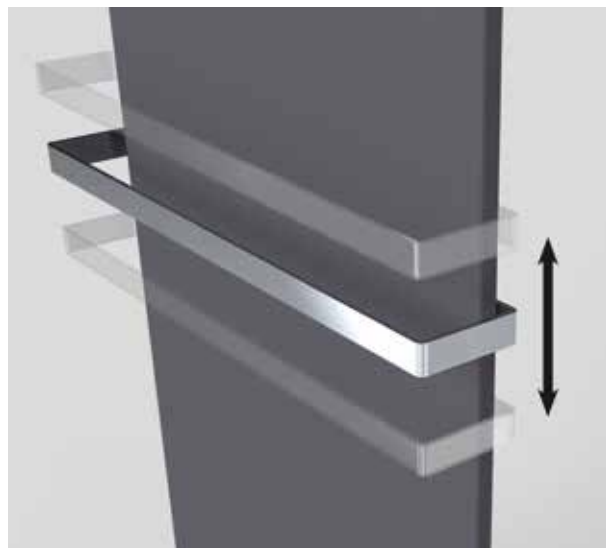
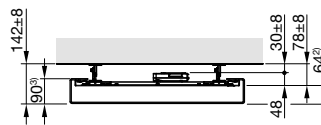
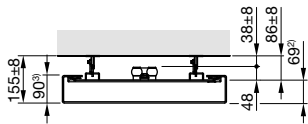
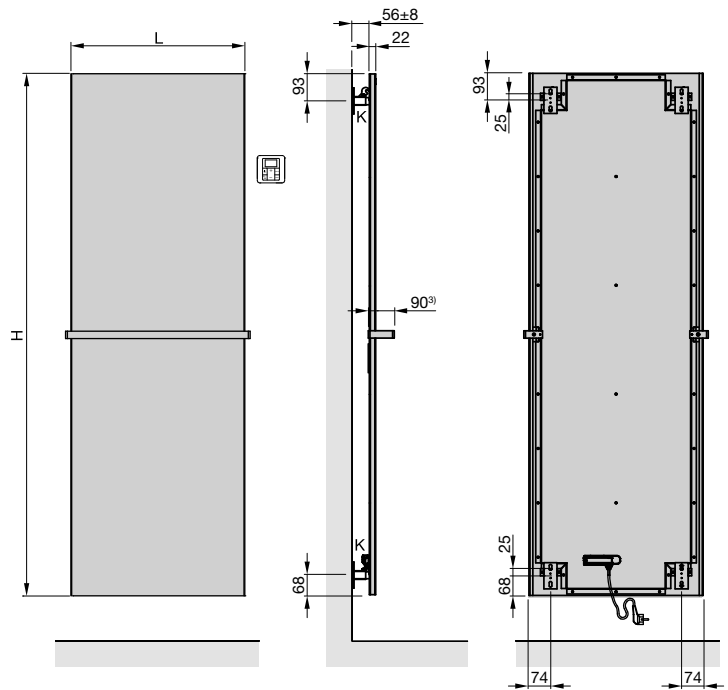
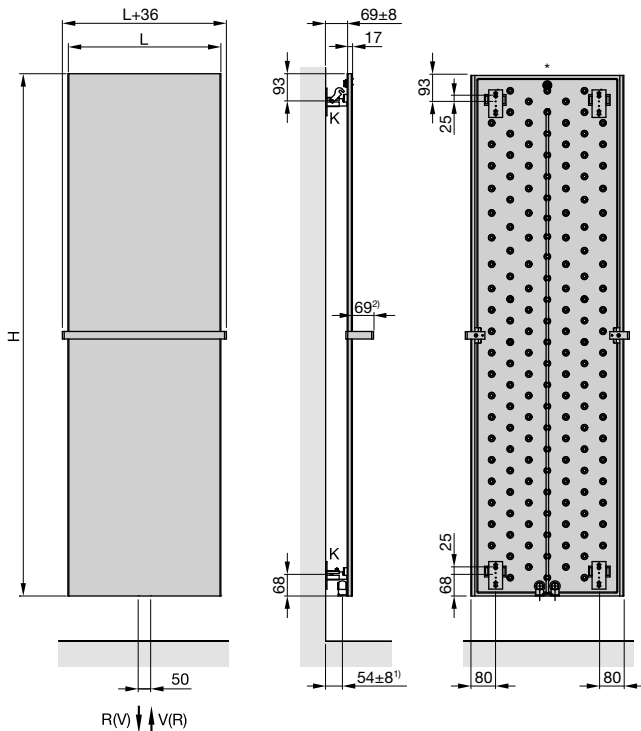

Towel rail is easy to adjust and can be positioned at any height.

Operation on central heating system: Detail suspension lug

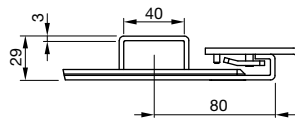

Electric operation: Detail suspension lug

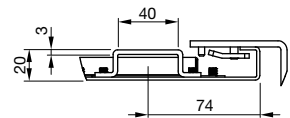

- H = Height
- L = Length
- V = Flow 1/2"
- R = Return 1/2"
- * = Venting 1/2"
- K = Bracket

Dimensions in mm

- 1) Distance from wall to middle of connection
- 2) Front edge of towel rail to front edge of radiator
- 3) Depth towel rail

Zehnder Klaro



Radiator surfaces: Chrome



Radiator colour: Traffic White

Operation on hot water central heating system

Zehnder Klaro makes a strong impression through its look and functionality. And the reason is its sophisticated tube design and variable wall clearance. The radiator is ideal for heating towels.

Zehnder Klaro decorative radiator made from horizontally arranged precision steel tubes Ø 23 mm with vertical, fully welded round tubes Ø 38 mm and invisible welds due to laser welding technology. Thermal output tested to EN 422, with CE marking.

Connections at top and bottom of the manifold tubes for flow, return, air vent, blanking plug, 4 x ½" female thread. Radiator with powder coating, in colour RAL 9016 as standard, in special colour or chrome, with packaging. Delivered ready to install with matching wall brackets.

Electric operation

Zehnder Klaro decorative radiator, electric-only, made from horizontally arranged precision steel tubes Ø 23 mm with vertical, fully welded round tubes Ø 38 mm and invisible welds due to laser welding technology.

Equipped with integrated electric heating element and control unit TIMERMEMO with connection cable 1,2 m long without plug, for mains supply of 230 V ± 10%, appliance class II.

Radiator with powder coating, in colour RAL 9016 as standard or in special colour, with packaging. Delivered ready to install with matching wall brackets.

Maximum operating pressure	max. 11,5 bar
Operating temperature	max. 120 °C
Height mm
Length mm
Model

Output Watt
Height mm
Length mm
Model

Benefits

- Flexible installation through bracket's variable wall clearance
- Mixed operation possible with T-piece
- Top-grade chrome finish

Special benefits of hot water operation

- High output due to internal tube design

Special benefits for electric operation with TIMERMEMO

- Energy-efficient and comfortable heating via innovative "open window detection"
- Low energy consumption of only 0,5 W in stand-by mode for increased energy efficiency
- Operation by smartphone with Zehnder Control app
- Comfortable operation as needed by customisable daily and weekly programme
- Timer function for on-demand operation
- With flying lead to connect in accordance with local electrical regulations



Connection to hot water central heating system or for dual energy operation

Overview of models

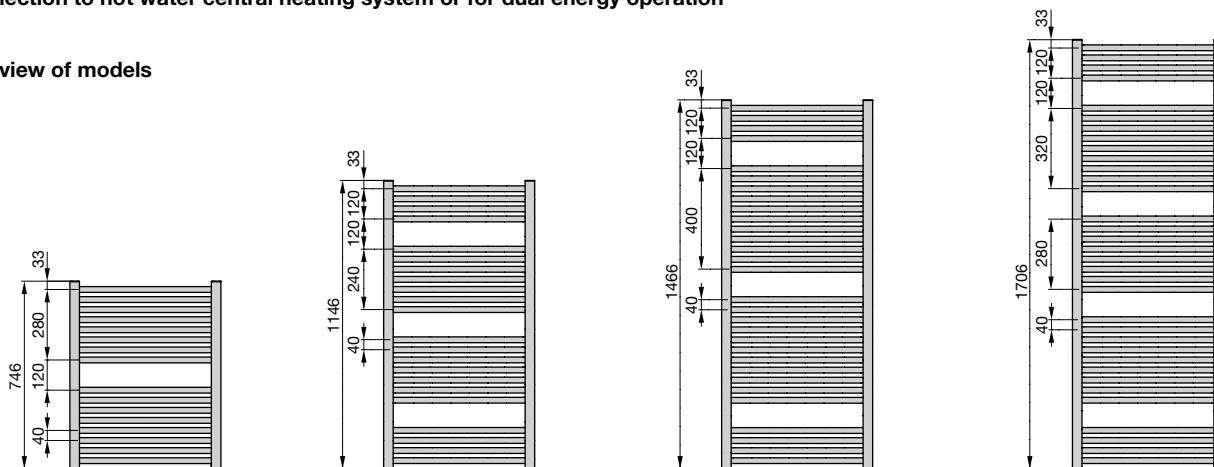

Painted version

Model	H mm	L mm	Thermal output				Exp. n	Classification Electric heating element Watt	V dm ³	M kg	Price RAL 9016 €	Price ^① Cat. 1 €
			EN 442 ^② Watt	70/55/24 Watt	55/45/24 Watt	55/45/20 Watt						
ZSL-080-045	746	450	354	252	155	186	1,25	300	3,6	5,4	273,94	342,42
ZSL-120-045	1146	450	521	369	224	270	1,27	300	5,4	8,1	318,37	397,97
ZSL-080-050	746	500	388	277	169	203	1,25	300	3,8	5,8	282,59	353,22
ZSL-120-050	1146	500	571	406	248	298	1,26	300	5,8	8,7	328,67	410,85
ZSL-150-050	1466	500	716	506	306	370	1,28	600	7,4	10,9	387,79	484,74
ZSL-170-050	1706	500	824	579	348	421	1,30	600	8,5	12,2	433,83	542,29
ZSL-080-060	746	600	455	324	199	238	1,26	300	4,3	6,7	295,46	369,33
ZSL-120-060	1146	600	670	476	291	349	1,26	600	6,6	9,8	347,56	434,45
ZSL-150-060	1466	600	839	593	359	433	1,28	600	8,5	12,3	407,46	509,33
ZSL-170-060	1706	600	966	683	413	499	1,28	900	9,6	14,2	460,19	575,24

Chrome-plated version

Model	H mm	L mm	Thermal output				Exp. n	Classification Electric heating element Watt	V dm ³	M kg	Price Chrome €
			EN 442 ^③ Watt	70/55/24 Watt	55/45/24 Watt	55/45/20 Watt					
ZSLC-080-050	746	500	283	199	120	145	1,30	-	3,8	5,8	977,90
ZSLC-120-050	1146	500	417	258	154	187	1,31	300	5,8	8,7	1.150,37
ZSLC-150-050	1466	500	475	334	201	239	1,33	300	7,4	10,5	1.420,60
ZSLC-170-050	1706	500	601	423	254	307	1,30	600	8,5	12,2	1.506,83
ZSLC-080-060	746	600	332	234	141	170	1,29	300	4,3	6,7	1.033,56
ZSLC-120-060	1146	600	489	343	205	248	1,31	300	6,6	9,8	1.215,86
ZSLC-150-060	1466	600	560	400	239	285	1,31	300	8,5	12,1	1.540,02
ZSLC-170-060	1706	600	705	494	296	358	1,31	600	9,6	14,2	1.629,25

① For special colours in categories 1 and 2, see “Special solutions” and “Colour chart”

② Thermal output measured according to EN 442, ΔT 50 K (75/65/20 °C)

Zehnder Klaro

Electric-only operation

Overview of models

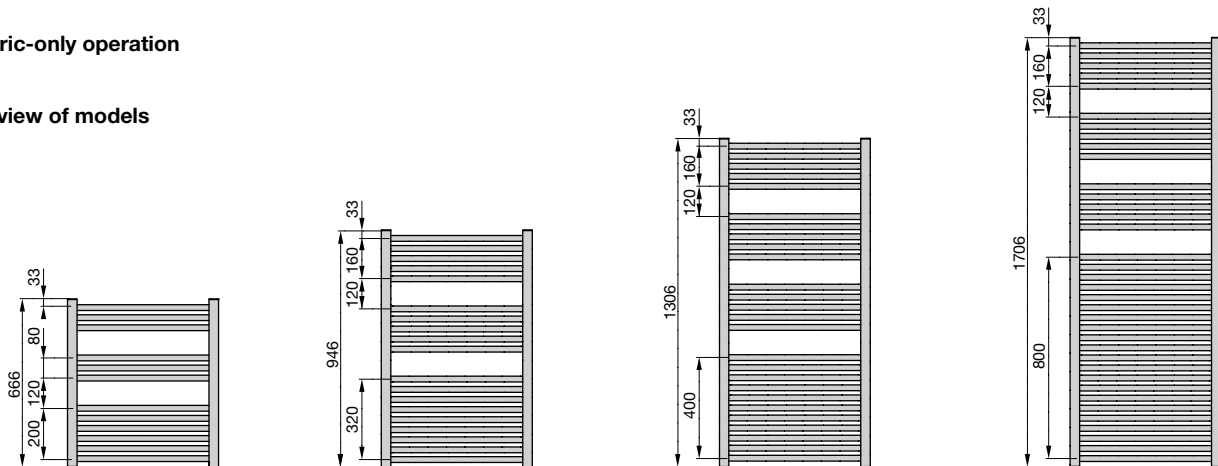

Electric-only operation

Painted version



Model	H ^②	L	Classification Electric heating element Watt	Price	Price ^①
	mm			mm	RAL 9016 €
ZSLE-120-040/TF	993	400	300	528,08	607,30
ZSLE-150-040/TF	1353	400	500	644,35	741,00
ZSLE-080-050/TF	713	500	300	452,17	520,00
ZSLE-120-050/TF	993	500	500	631,01	725,65
ZSLE-150-050/TF	1353	500	750	659,81	758,77
ZSLE-180-050/TF	1753	500	1000	776,56	893,04

Standard scope of delivery for operation on hot water heating system

- Powder coating to DIN 55900, RAL 9016
- 4 x ½" connections for flow, return, air vent and plug
- 1 air vent ½" and 1 blind plug ½"
- Mounting accessories in colour of radiator
- Packaging

Standard scope of delivery for electric operation

- Powder coating to DIN 55900, RAL 9016
- Filled with heat transfer liquid
- With integrated electric heating element and control unit
TIMERMEMO in white, mounted on right side
- Mounting accessories in colour of radiator
- Packaging

Special version on request (surcharge)	Article number	Price €
■ Special colour to category 2 (surcharge on cat. 1)		146,76
■ Surface in metal look: stainless steel look (reduced output approx. 13%)		As in cat. 1
■ Electric heating elements and T-piece for dual-energy operation	☐ 🔧	See p. 161 onwards
■ Accessories	-	See page 160
■ Lambswool cleaning brush	601040	60,41
■ Zehnder valves, lockshield valves and connection fittings	-	See p. 165 onwards

① For special colours in categories 1 and 2, see "Special solutions" and "Colour chart"

② Total height incl. electric heating element

For legend, see "Electric operation and Ecodesign Directive" on page 173 ☐ 🔧

Zehnder Klaro



Operation on hot water central heating system:

Wall mounting
connection from bottom

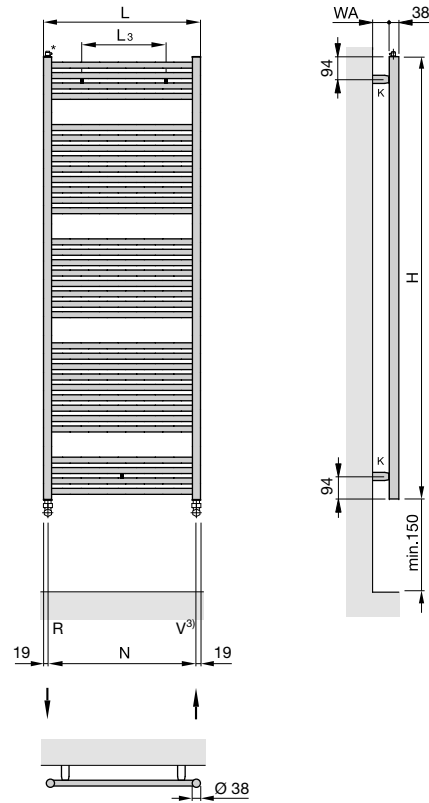

Electric operation: with electric heating element TIMERMEMO

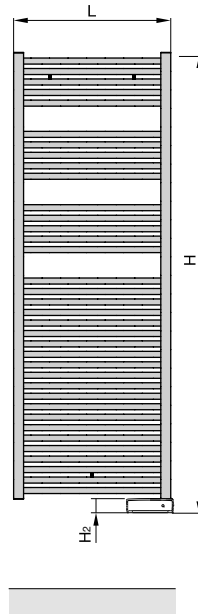

Dual energy operation:

Connection to hot water central heating
with electric heating element (fig. with
RICA) and T-piece in return

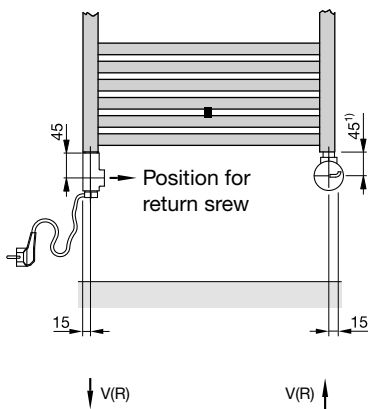

- H = Height
- H₂ = 47 mm
- L = Length
- K = Bracket
- WA = Wall clearance 51 - 61 mm
- V = Flow 1/2"
- R = Return 1/2"
- * = Air vent 1/2"
- EL = Connection for electric heating element
- N = Boss spacing = L - 38 mm
- L₃ = Fixing dimension, L - 200 mm

Dimensions in mm

3) Changing of flow/return by turning radiator
on its own axis

Zehnder Stalox



Radiator surface: Chrome



Operation on hot water central heating & open heating systems

Zehnder Stalox decorative radiator made from V4A polished stainless steel comprising horizontally arranged round tubes welded with vertical, square manifold tubes. Square manifold tubes 30 x 30 mm, horizontal round tubes Ø 23 mm. Thermal output to EN 422, with CE marking. 2 x 1/2" connection at the ends of the manifold tubes for flow, return and air vent. Delivered ready to install with matching wall brackets in stainless steel look and packaging. Radiator also available with powder coating in colour RAL 9016.

Benefits

- For open heating system
- Entry-level model suitable for all types of tender businesses
- Small depth
- Flow and return freely selectable
- Classic design with square collectors
- Transparent look

Maximum operating pressure	max. 12 bar
Operating temperature	max. 120 °C
Height mm
Length mm
Model

Zehnder Stalox



Overview of models

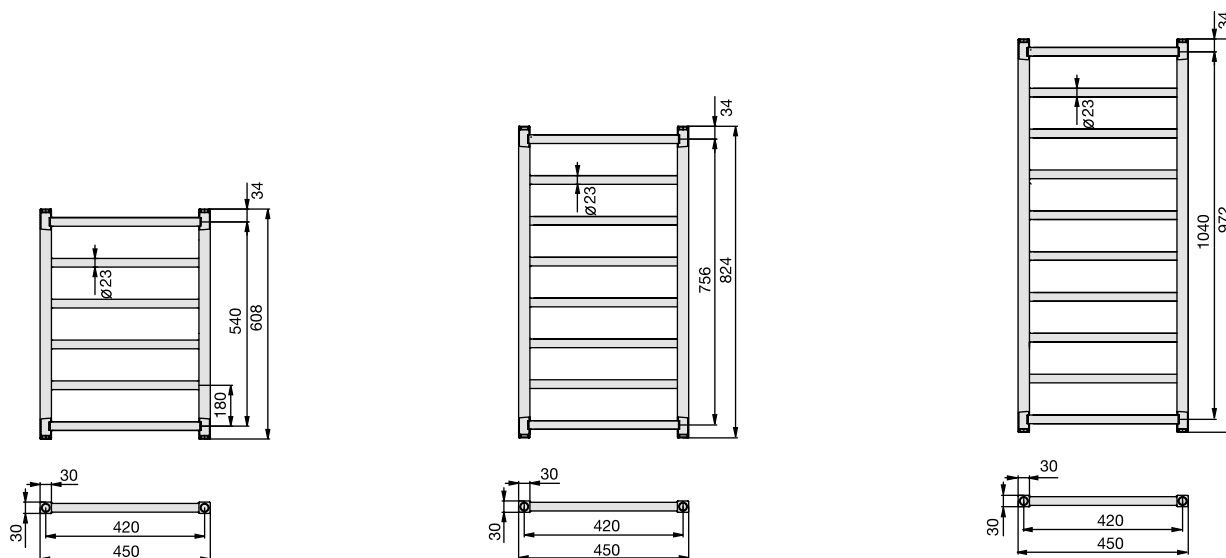

Connection to hot water central heating and open heating systems

Painted version

Model	H mm	L mm	Thermal output				Exp. n	Classification Electric heating element Watt	V dm ³	M kg	Price RAL 9016 €
			EN 442① Watt	70/55/24 Watt	55/45/24 Watt	55/45/20 Watt					
STX-060-045	608	450	190	145	83	102	1,20	-	1,7	3,4	459,48
STX-080-045	824	450	247	189	108	133	1,20	-	2,3	4,5	512,93
STX-100-045	1040	450	310	237	135	166	1,21	300	2,8	5,6	612,31

High gloss stainless steel version

Model	H mm	L mm	Thermal output				Exp. n	Classification Electric heating element Watt	V dm ³	M kg	Price Stainless steel €
			EN 442① Watt	70/55/24 Watt	55/45/24 Watt	55/45/20 Watt					
STXI-060-045	608	450	125	96	55	68	1,17	-	1,6	3,7	654,89
STXI-080-045	824	450	167	128	73	88	1,25	-	2,2	4,9	754,30
STXI-100-045	1040	450	209	160	91	109	1,26	-	2,6	6,3	887,39

Standard scope of delivery for hot water central heating & open heating system

- High gloss stainless steel or on powder coating to DN55900, RAL 9016 on request
- 2 x 1/2" connections at bottom on the manifold tube
- Air vent 1/4"
- Mounting accessories in stainless steel look
- Packaging

Special version on request (surcharge)	Article number	Price €
■ Electric heating element for dual energy operation	-	See p. 161 onwards
■ Zehnder valves, lockshield valves and connection fittings	-	See p. 165 onwards

① Thermal output measured according to EN 442, ΔT 50 K (75/65/20 °C)

Zehnder Bluebell



Radiator surface: Stainless steel

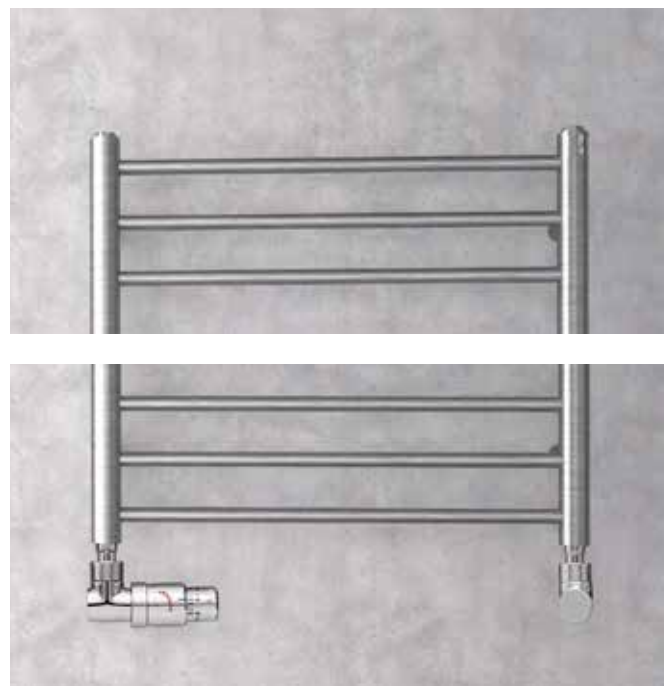

Operation on hot water central heating & open heating systems

Zehnder Bluebell decorative radiator made from V4A stainless steel comprising horizontally arranged Ø 16 mm round tubes welded with vertical Ø 32 mm round manifold tubes. Thermal output to EN 422, with CE marking. 2 x ½" connection at the end of the manifold tubes for flow, return and air vent. Delivered ready to install with matching wall brackets in stainless steel and packaging.

Benefits

- For open heating system
- Entry-level model suitable for all types of tender businesses
- Small depth
- Flow and return freely selectable
- Classic and sophisticated design with round collectors

Maximum operating pressure	max. 13,0 bar
Operating temperature	max. 120 °C
Height mm
Length mm
Model

Zehnder Bluebell



Overview of models

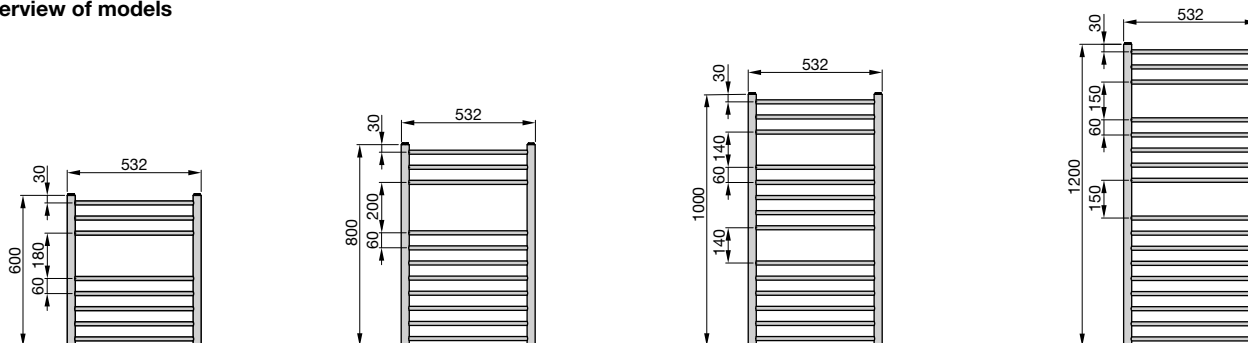

Connection to hot water central heating and open heating systems

Stainless steel version

Model	H mm	L mm	Thermal output				Exp. n	V dm ³	M kg	Price Stainless steel €
			EN 442③ Watt	70/55/24 Watt	55/45/24 Watt	55/45/20 Watt				
BLU-060-053	600	532	157	105	58	72	1,50	1,36	3,29	653,23
BLU-080-053	800	532	199	128	68	86	1,63	1,83	4,35	694,93
BLU-100-053	1000	532	248	155	78	101	1,74	2,3	5,41	792,22
BLU-120-053	1200	532	307	179	82	109	2,00	2,78	6,47	910,36

Connection to hot water central heating system:

Wall mounting

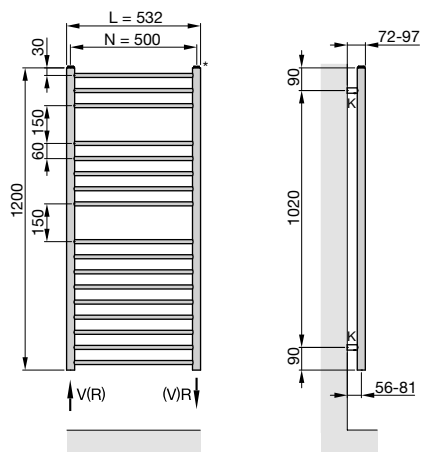

- H = Height
- L = Length
- K = Bracket = 90
- V = Flow 1/2"
- R = Return 1/2"
- N = Boss spacing
- * = Air vent

Dimensions in mm

Zehnder Aura



Radiator colour: Traffic White

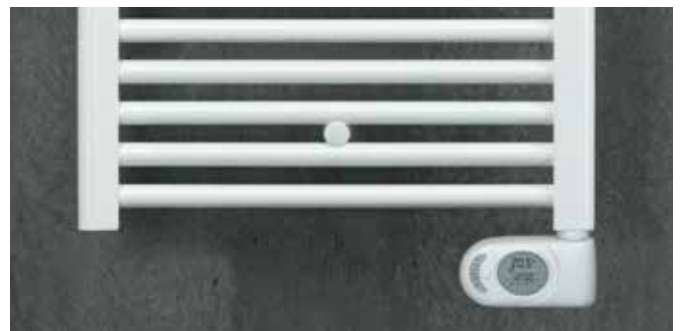

Radiator for electric operation with Musa Eco

Operation on hot water central heating system

Zehnder Aura decorative radiator made from horizontally arranged precision steel tubes with vertical D-profile tubes. Round tube Ø 22 mm, D-tube 30 x 40 mm. Thermal output tested to EN 422, with CE marking. 4 x ½" for flow/return in the manifold tube with air vent ¼". Alternatively with centre connections ½", distance 50 mm, flow and return freely selectable. Delivered ready to install with matching wall brackets. Radiator with powder coating, in colour RAL 9016 as standard and in chrome, with packaging.

Maximum operating pressure	max. 10,0 bar
Operating temperature	max. 90 °C
Height mm
Length mm
Model

Benefits

- Harmonious design through D-profile of vertical tubes
- Large cut-outs
- Top-grade chrome finish
- Easy to clean
- Entry-level model for all types of tender businesses
- Dual energy operation possible with T-piece

Standard scope of delivery

- Powder coating to DIN55900, RAL 9016
- 2 x ½" connections for flow, return or 4 x ½" connections for flow, return, electric heating element
- 1 x blind plug ½" or 3 x blind plug ½" with middle connection
- 1 x air vent ½"
- Accessories in colour of radiator
- Packaging

Electric operation

Zehnder Aura decorative radiator made from horizontally arranged precision steel tubes with vertical D-profile tubes. Round tube Ø 22 mm, D-tube 30 x 40 mm. With built-in electric heating element Musa Eco. Protection class IP 44 (splash-proof), for mains power supply of 230 V. Connection cable (1,3 m) with Euro plug. Installation at bottom right. Decorative radiator filled with heat transfer fluid.

Delivered ready to install with elegant wall brackets. Standard version with powder coating, in colour RAL 9016, in special colour on request.

Benefits

- High energy efficiency due to compliance with the European Ecodesign Directive reduces energy costs
- User-friendly control device allows simple operation
- Customisable daily and weekly programmes for convenient, on-demand operation
- Increased safety with keylock

Standard scope of delivery

- Powder coating to DIN 55900, RAL 9016
- Filled with heat transfer liquid
- With integrated electric heating element MUSA Eco with seven operational modes: comfort, night, anti-freeze, fil-pilot, chrono, timer- 2h, stand-by, right-mounted
- Mounting accessories in colour of radiator
- Packaging

Overview of models

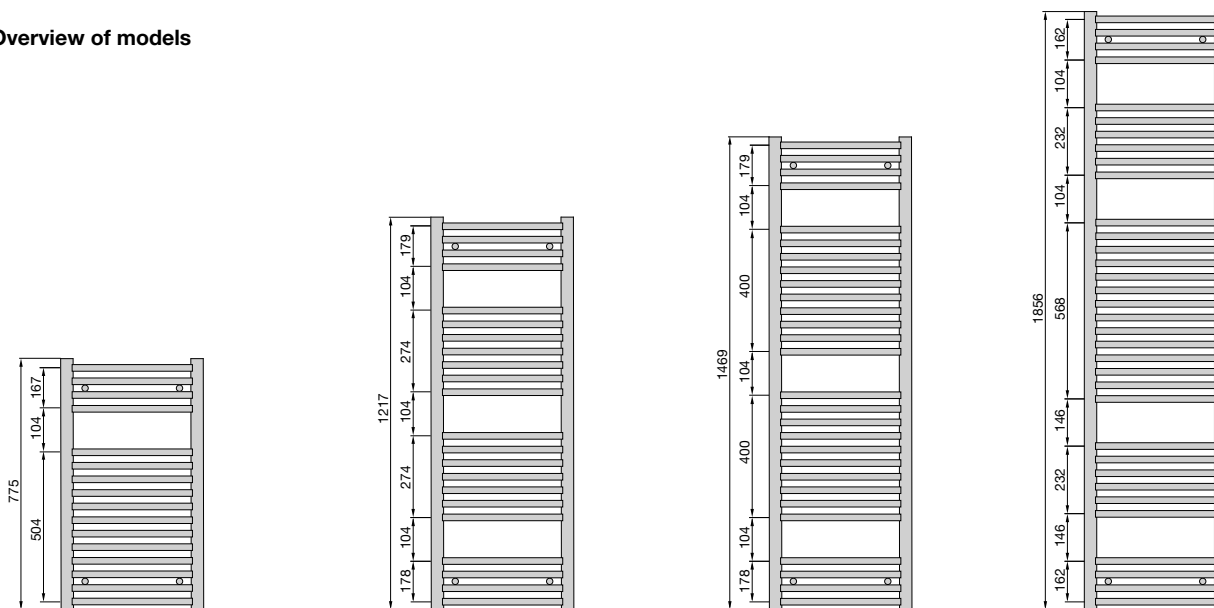

Connection to hot water central heating system or for dual energy operation

Minimum quantity per order:
10 pcs

Painted version, connection from bottom

Model	H mm	L mm	Thermal output				Exp. n	Classification Electric heating element Watt	V dm ³	M kg	Price RAL 9016 €
			EN 442 ^③ Watt	70/55/24 Watt	55/45/24 Watt	55/45/20 Watt					
PBN-080-045	775	450	327	234	146	176	1,20	300	3,4	5,3	106,04
PBN-120-045	1217	450	468	335	207	248	1,23	300	4,8	7,7	152,54
PBN-150-045	1469	450	575	410	253	303	1,24	300	6,0	9,6	168,05
PBN-180-045	1856	450	719	511	314	379	1,24	600	7,4	12,0	192,29
PBN-080-050	775	500	358	257	161	193	1,20	300	3,6	5,8	109,14
PBN-120-050	1217	500	512	365	225	271	1,23	300	5,2	8,3	157,21
PBN-150-050	1469	500	631	449	276	332	1,24	600	6,5	10,4	172,49
PBN-180-050	1856	500	788	560	344	415	1,24	600	8,0	12,8	200,08
PBN-080-060	775	600	418	303	190	226	1,19	300	4,1	6,6	113,80
PBN-120-060	1217	600	598	424	262	317	1,23	600	5,9	9,6	164,95
PBN-150-060	1469	600	740	525	324	392	1,23	600	7,4	11,9	181,61
PBN-180-060	1856	600	925	656	404	487	1,24	900	9,1	14,6	210,82

Painted version, connection central 50 mm

Model	H mm	L mm	Thermal output				Exp. n	Classification Electric heating element Watt	V dm ³	M kg	Price RAL 9016 €
			EN 442 ^③ Watt	70/55/24 Watt	55/45/24 Watt	55/45/20 Watt					
PBN-080-045-05	775	450	327	234	146	176	1,20	300	3,4	5,3	122,40
PBN-120-045-05	1217	450	468	335	207	248	1,23	300	4,8	7,7	170,31
PBN-150-045-05	1469	450	575	410	253	303	1,24	300	6,0	9,6	186,28
PBN-180-045-05	1856	450	719	511	314	379	1,24	600	7,4	12,0	211,27
PBN-080-050-05	775	500	358	257	161	193	1,20	300	3,6	5,8	125,60
PBN-120-050-05	1217	500	512	365	225	271	1,23	300	5,2	8,3	175,11
PBN-150-050-05	1469	500	631	449	276	332	1,24	600	6,5	10,4	190,84
PBN-180-050-05	1856	500	788	560	344	415	1,24	600	8,0	12,8	219,24
PBN-080-060-05	775	600	418	303	190	226	1,19	300	4,1	6,6	130,38
PBN-120-060-05	1217	600	598	424	262	317	1,23	600	5,9	9,6	183,06
PBN-150-060-05	1469	600	740	525	324	392	1,23	600	7,4	11,9	200,19
PBN-180-060-05	1856	600	925	656	404	487	1,24	900	9,1	14,6	230,31

③ Thermal output measured according to EN 442, ΔT 50 K (75/65/20 °C)

Zehnder Aura

Connection to hot water central heating system or for dual energy operation

Minimum quantity per order:
10 pcs

Painted version black matt, connection from bottom

Model	H mm	L mm	Thermal output				Exp. n	Classification Electric heating element Watt	V dm ³	M kg	Price Chrome €
			EN 442 ³ Watt	70/55/24 Watt	55/45/24 Watt	55/45/20 Watt					
PBN-080-045-9205	775	450	327	234	146	176	1,20	-	3,40	5,30	132,55
PBN-120-045-9205	1217	450	468	335	207	248	1,23	-	4,80	7,70	190,68
PBN-150-045-9205	1469	450	575	410	253	303	1,24	-	6,00	9,60	210,07
PBN-180-045-9205	1856	450	719	511	314	379	1,24	-	7,40	12,00	240,37
PBN-080-050-9205	775	500	358	257	161	193	1,20	-	3,60	5,80	136,42
PBN-120-050-9205	1217	500	512	365	225	271	1,23	-	5,20	8,30	196,51
PBN-150-050-9205	1469	500	631	449	276	332	1,24	-	6,50	10,40	215,61
PBN-180-050-9205	1856	500	788	560	344	415	1,24	-	8,00	12,80	250,1
PBN-080-060-9205	775	600	418	303	190	226	1,19	-	4,10	6,60	142,25
PBN-120-060-9205	1217	600	598	424	262	317	1,23	-	5,90	9,60	206,18
PBN-150-060-9205	1469	600	740	525	324	392	1,23	-	7,40	11,90	227,01
PBN-180-060-9205	1856	600	925	656	404	487	1,24	-	9,10	14,60	263,53

Connection to hot water central heating system or for dual energy operation

Chrome-plated version, connection from bottom

Model	H mm	L mm	Thermal output				Exp. n	Classification Electric heating element Watt	V dm ³	M kg	Price Chrome €
			EN 442 ³ Watt	70/55/24 Watt	55/45/24 Watt	55/45/20 Watt					
PBCN-080-045	775	450	206	145	87	105	1,30	-	3,4	5,5	208,26
PBCN-120-045	1217	450	303	213	128	155	1,30	300	4,8	8,0	283,68
PBCN-150-045	1469	450	368	259	155	188	1,30	300	6,0	9,8	332,14
PBCN-180-045	1856	450	468	329	198	239	1,30	300	7,4	12,2	389,17
PBCN-080-050	775	500	230	161	98	119	1,28	-	3,6	5,9	214,70
PBCN-120-050	1217	500	330	232	140	169	1,29	300	5,2	8,5	292,45
PBCN-150-050	1469	500	407	284	171	209	1,29	300	6,5	10,5	342,42
PBCN-180-050	1856	500	513	360	217	262	1,30	300	8,0	13,0	401,21
PBCN-080-060	775	600	271	195	119	142	1,25	-	4,1	6,7	220,72
PBCN-120-060	1217	600	390	273	165	201	1,28	300	5,9	9,6	301,49
PBCN-150-060	1469	600	481	338	204	248	1,28	300	7,4	11,9	355,75
PBCN-180-060	1856	600	607	425	257	312	1,29	600	9,1	14,7	424,67

Chrome-plated version, connection central 50 mm

Model	H mm	L mm	Thermal output				Exp. n	Classification Electric heating element Watt	V dm ³	M kg	Price Chrome €
			EN 442 ³ Watt	70/55/24 Watt	55/45/24 Watt	55/45/20 Watt					
PBCN-120-045-05	1217	450	303	213	128	155	1,30	300	4,8	8,0	306,74
PBCN-150-045-05	1469	450	368	259	155	188	1,30	300	6,0	9,8	356,92
PBCN-180-045-05	1856	450	468	329	198	239	1,30	300	7,4	12,2	416,00
PBCN-080-050-05	775	500	230	161	98	119	1,28	-	3,6	5,9	234,33
PBCN-120-050-05	1217	500	330	232	140	169	1,29	300	5,2	8,5	314,42
PBCN-150-050-05	1469	500	407	284	171	209	1,29	300	6,5	10,5	365,85
PBCN-180-050-05	1856	500	513	360	217	262	1,30	300	8,0	13,0	426,40
PBCN-120-060-05	1217	600	390	273	165	201	1,28	300	5,9	9,6	323,70
PBCN-150-060-05	1469	600	481	338	204	248	1,28	300	7,4	11,9	379,62
PBCN-180-060-05	1856	600	607	425	257	312	1,29	600	9,1	14,7	450,61

Zehnder Aura



Electric-only operation

Minimum quantity per order:
10 pcs

Painted version

Model	H ^③ mm	L mm	Classification Electric heating element Watt	Price RAL 9016 €
PBEZ-080-40/MQ	786	400	300	252,06
PBEZ-090-50/MQ	906	500	500	276,51
PBEZ-120-50/MQ	1226	500	750	319,20
PBEZ-180-50/MQ	1866	500	1000	398,25
PBEZ-120-60/MQ	1226	600	750	333,44
PBEZ-150-60/MQ	1466	600	1000	364,70
PBEZ-180-60/MQ	1866	600	1000	419,39



Chrome-plated version

Model	H ^③ mm	L mm	Classification Electric heating element Watt	Price Chrome €
PBECZ-080-40/MQ	786	400	150	294,65
PBECZ-090-50/MQ	906	500	200	324,66
PBECZ-120-50/MQ	1226	500	300	378,70
PBECZ-180-50/MQ	1866	500	500	478,10
PBECZ-120-60/MQ	1226	600	400	397,07
PBECZ-150-60/MQ	1466	600	400	432,05
PBECZ-180-60/MQ	1866	600	600	505,20

Black matt version

Model	H ^③ mm	H + Musa Eco mm	L mm	Classification Electric heating element Watt	Price (gross) €
PBEBZ-080-40/MQ	786	860	400	300	272,21
PBEBZ-090-50/MQ	906	980	500	500	298,64
PBEBZ-120-50/MQ	1226	1300	500	750	347,91
PBEBZ-150-60/MQ	1466	1540	600	1000	397,50

Accessories (surcharge)	Article number	Price €
■ Electric heating element for dual energy operation	-	See p. 161 onwards
■ Zehnder valves, lockshield valves and connection fittings	-	See p. 165 onwards
■ Zehnder thermostat LH2, M 30 x 1.5, white	819140	35,02
■ Zehnder thermostat LH2, M 30 x 1.5, chrome	819148	60,35

③ Thermal output measured according to EN 442, ΔT 50 K (75/65/20 °C)

Zehnder Aura

Operation on hot water central heating system:

Wall mounting

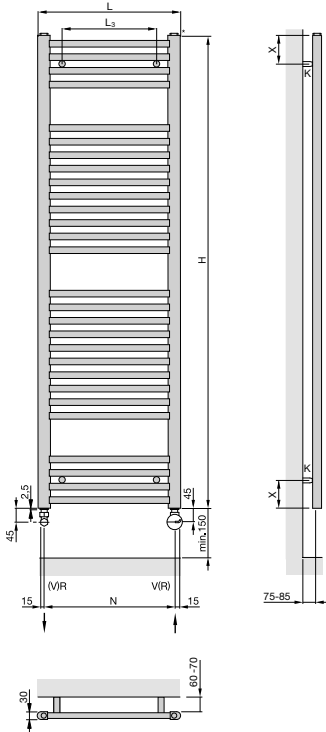

Wall mounting
centre connections 50 mm

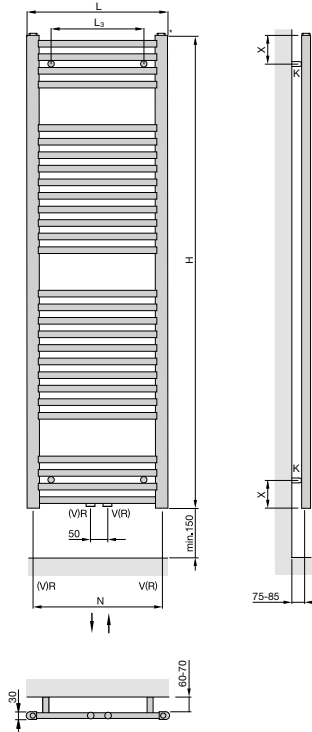

Electric operation:

with electric heating element
Musa Eco

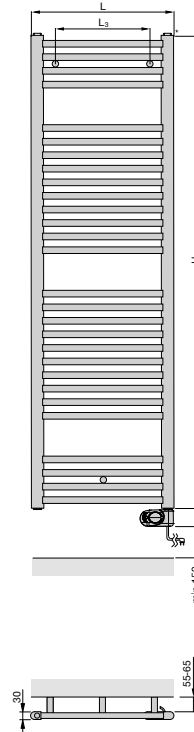

Dual energy operation:

with valve block 50 mm angled
and electric heating element DBM

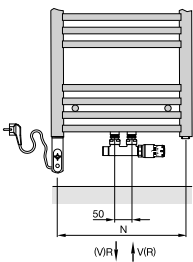

- H = Height
- L = Length
- K = Bracket
- V = Flow 1/2"
- R = Return 1/2"
- N = Boss spacing, L - 50 mm
- L₃ = Length - 150 mm
- X = Fixing point

Dimensions in mm

Hot water central heating version

H (mm)	X (mm)
775	94
1217	105
1469	105
1856	88

Electric operation

H (mm)	H with controller (mm)	X (mm)
786	860	93
906	980	93
1226	1300	93
1466	1540	93
1866	1940	93

Zehnder Aura Bow

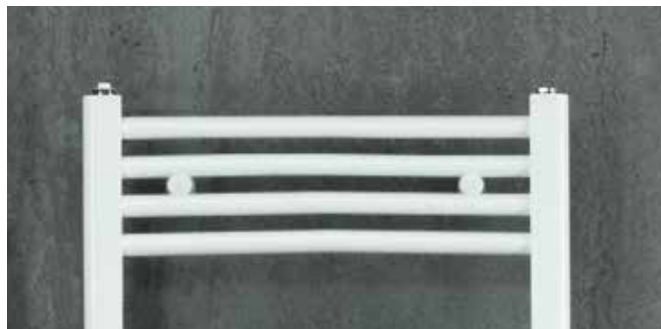

Radiator surface: Chrome

Operation on hot water central heating system

Zehnder Aura Bow decorative radiator made from horizontally arranged precision steel curved tubes with vertical D-profile tubes. Round tube Ø 22 mm, D-tube 30 x 40 mm. Thermal output tested to EN 422, with CE marking. 4 x 1/2" for flow/return in the manifold tube with air vent 1/4". Alternatively with centre connections 1/2", distance 50 mm, flow and return freely selectable. Delivered ready to install with matching wall brackets. Radiator with powder coating, in colour RAL 9016 as standard and in chrome, with packaging.

Maximum operating pressure	max. 10,0 bar
Operating temperature	max. 90 °C
Height mm
Length mm
Model

Benefits

- Harmonious design
- Large cut-outs
- Top-grade chrome finish
- Easy to clean
- Entry-level model for all types of tender businesses
- Attractive curvature

Standard scope of delivery

- Powder coating to DIN 55900, RAL 9016
- 2 x 1/2" connections for flow, return or 4 x 1/2" connections for flow, return, electric heating element
- 1 x blind plug 1/2" or 3 x blind plug 1/2" with middle connection
- 1 x air vent 1/2"
- Accessories in colour of radiator
- Packaging

Zehnder Aura Bow

Overview of models

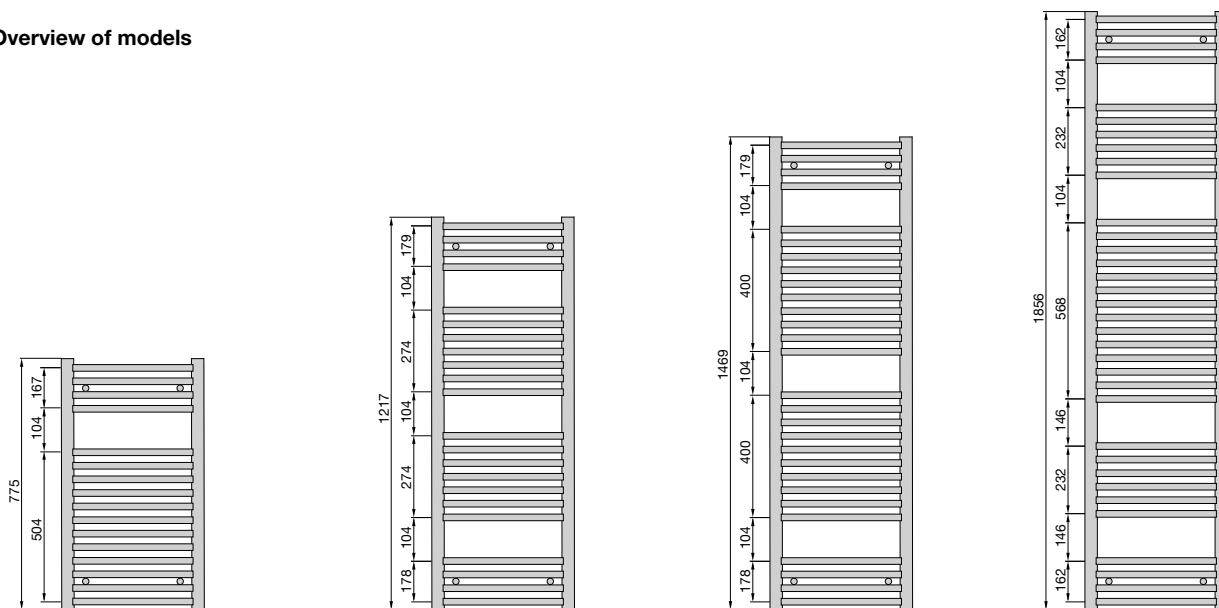

Connection to hot water central heating system or for dual energy operation

Minimum quantity per order:
10 pcs

Painted version, connection from bottom

Model	H mm	L mm	Thermal output				Exp. n	Classification Electric heating element Watt	V dm ³	M kg	Price RAL 9016 €
			EN 442 ^③ Watt	70/55/24 Watt	55/45/24 Watt	55/45/20 Watt					
PBTN-080-050	775	494	358	257	161	193	1,20	300	3,6	5,8	123,50
PBTN-120-050	1217	494	512	365	225	271	1,23	300	5,2	8,3	173,01
PBTN-150-050	1469	494	631	450	276	332	1,24	600	6,5	10,4	188,78
PBTN-180-050	1856	494	788	560	344	415	1,24	600	8,0	12,8	217,14
PBTN-080-060	775	595	418	303	190	226	1,19	300	4,1	6,6	128,30
PBTN-120-060	1217	595	598	424	262	317	1,23	600	5,9	9,6	181,00
PBTN-150-060	1469	595	740	525	324	392	1,23	600	7,4	11,9	198,11
PBTN-180-060	1856	595	925	656	404	487	1,24	900	9,1	14,6	228,25

Painted version, connection central 50 mm

Model	H mm	L mm	Thermal output				Exp. n	Classification Electric heating element Watt	V dm ³	M kg	Price RAL 9016 €
			EN 442 ^③ Watt	70/55/24 Watt	55/45/24 Watt	55/45/20 Watt					
PBTN-080-050-05	775	494	358	257	161	193	1,20	300	3,6	5,8	136,69
PBTN-120-050-05	1217	494	512	365	225	271	1,23	300	5,2	8,3	186,19
PBTN-150-050-05	1469	494	631	450	276	332	1,24	600	6,5	10,4	201,93
PBTN-180-050-05	1856	494	788	560	344	415	1,24	600	8,0	12,8	230,31
PBTN-080-060-05	775	595	418	303	190	226	1,19	300	4,1	6,6	141,45
PBTN-120-060-05	1217	595	598	424	262	317	1,23	600	5,9	9,6	194,17
PBTN-150-060-05	1469	595	740	525	324	392	1,23	600	7,4	11,9	211,32
PBTN-180-060-05	1856	595	925	656	404	487	1,24	900	9,1	14,6	241,42

③ Thermal output measured according to EN 442, ΔT 50 K (75/65/20 °C)

Zehnder Aura Bow





Connection to hot water central heating system or for dual energy operation

Minimum quantity per order:
10 pcs

Chrome-plated version, connection from bottom

Model	H mm	L mm	Thermal output				Exp. n	Classification Electric heating element Watt	V dm ³	M kg	Price Chrome €
			EN 442 ^③ Watt	70/55/24 Watt	55/45/24 Watt	55/45/20 Watt					
PBTCN-080-050	775	494	230	161	98	119	1,28	-	3,6	5,9	238,88
PBTCN-120-050	1217	494	330	232	140	169	1,29	300	5,2	8,5	309,66
PBTCN-150-050	1469	494	407	284	171	209	1,29	300	6,5	10,5	359,65
PBTCN-180-050	1856	494	513	360	217	262	1,30	300	8,0	13,0	418,41
PBTCN-080-060	775	595	271	195	119	142	1,25	-	4,1	6,7	237,95
PBTCN-120-060	1217	595	390	273	165	201	1,28	300	5,9	9,6	318,72
PBTCN-150-060	1469	595	481	338	204	248	1,28	300	7,4	11,9	372,98
PBTCN-180-060	1856	595	607	425	257	312	1,29	600	9,1	14,7	441,89

Accessories (surcharge)	Article number	Price €
■ Electric heating element for dual energy operation  	-	See p. 161 onwards
■ Zehnder valves, lockshield valves and connection fittings	-	See p. 165 onwards
■ Zehnder thermostat LH2, M 30 x 1,5, white	819140	35,02
■ Zehnder thermostat LH2, M 30 x 1,5, chrome	819148	60,35

③ Thermal output measured according to EN 442, ΔT 50 K (75/65/20 °C)

Zehnder Aura Bow

Operation on hot water central heating system:

Wall mounting

Wall mounting
centre connections 50 mm

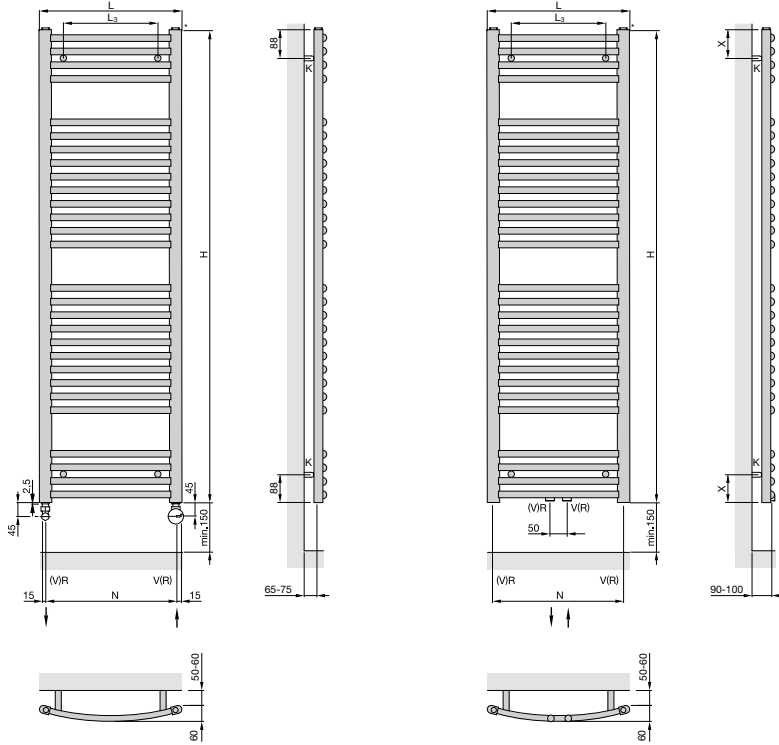

- H = Height
- L = Length
- K = Bracket
- V = Flow 1/2"
- R = Return 1/2"
- N = Boss spacing, L - 50 mm
- T = 60 mm
- L₃ = Length - 150 mm
- X = Fixing point

Dimensions in mm

H (mm)	X (mm)
775	94
1217	105
1469	105
1856	88

Dual energy operation:

with valve block 50 mm angled
and electric heating element DBM

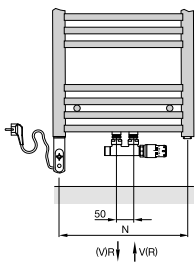

BATHROOM ESSENTIALS

Bathroom Essentials

from page 130

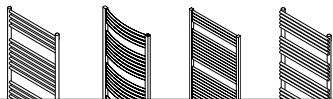

Zehnder Virando



Radiator surface: Beach Gold

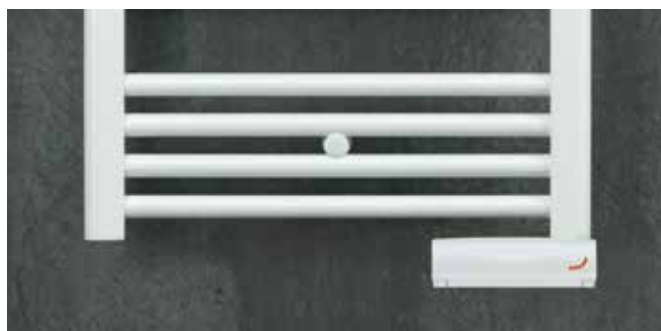

Radiator for electric operation with TIMERMEMO

Hot water operation

Clarity and class. Zehnder Virando has what any lover of modern style looks for. A clear design, with horizontal and straight tube elements allows for ample space for hanging towels. Zehnder Virando designer radiator made from horizontally arranged precision steel tubes with vertical D-profile tubes. Round tubes Ø 23 mm, D-tubes 30 x 40 mm. Available in almost any colour and finish from the Zehnder colour chart. Delivered ready to install with matching wall brackets, packaging.

Maximum operating pressure
Operating temperature

max. 12 bar
max. 120 °C

Benefits

- Timeless design creates an aesthetic accent
- Generous spaces between the tubes convenient for hanging towels
- Top-grade chrome finish
- Ample spaces between tubes make cleaning easy
- Flexible installation due to 50 mm centre connections

Special benefits for electric operation with TIMERMEMO

- Energy-efficient and comfortable heating via innovative “open window detection”
- Low energy consumption of only 0,5 W in stand-by mode for increased energy efficiency
- Operation by smartphone with Zehnder Control app
- Comfortable operation as needed by customisable daily and weekly programme
- Timer function for on-demand operation
- With flying lead to connect in accordance with local electrical regulations



Zehnder Virando

Overview of models

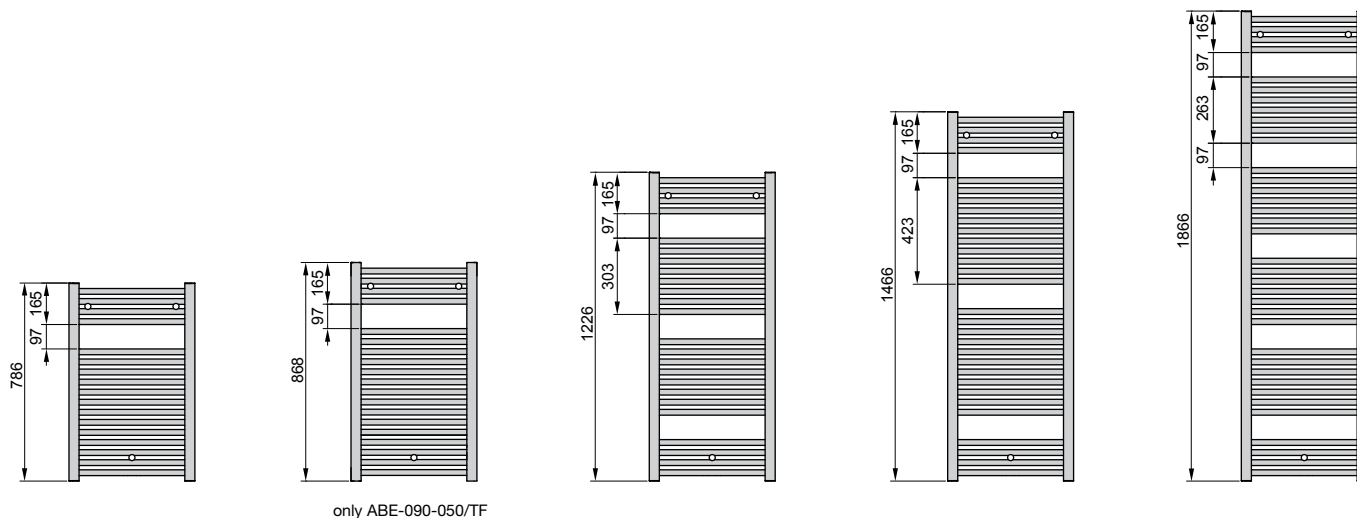

Connection to hot water central heating system or for dual energy operation

Painted version, connection from bottom

Model	H mm	L mm	Thermal output				Exp. n	Classification immersion heater Watt	V dm³	M kg	Price RAL 9016 €	Price Cat. 1 €	Price Cat. 2 €
			EN 442 [Ⓞ] Watt	70/55/24 Watt	55/45/24 Watt	55/45/20 Watt							
AB-080-045	786	450	344	244	149	179	1,26	300	3,6	5,6	80,67	100,84	174,21
AB-120-045	1226	450	505	358	218	262	1,27	300	5,3	8,2	101,62	127,03	200,40
AB-080-050	786	500	379	269	164	197	1,26	300	3,9	6,0	83,97	104,97	178,35
AB-120-050	1226	500	552	391	237	286	1,27	300	5,7	9,0	107,16	133,94	207,33
AB-150-050	1466	500	678	481	293	353	1,27	600	7,2	11,0	123,95	154,94	228,32
AB-180-050	1866	500	830	590	360	433	1,26	600	8,7	13,5	143,90	179,86	253,24
AB-080-060	786	600	448	318	194	234	1,26	300	4,6	7,0	91,85	114,81	188,19
AB-120-060	1226	600	648	460	280	337	1,26	600	6,6	10,0	116,88	146,09	219,47
AB-150-060	1466	600	794	565	346	415	1,25	600	8,2	12,7	137,39	171,73	245,11
AB-180-060	1866	600	978	697	427	512	1,25	900	9,9	16,0	161,43	201,78	275,17
AB-120-075	1226	750	791	562	343	412	1,26	600	7,9	12,4	125,71	157,13	230,52
AB-150-075	1466	750	968	691	424	509	1,24	900	9,7	15,2	157,68	197,09	270,47
AB-180-075	1866	750	1230	879	540	648	1,24	900	11,7	18,4	183,75	229,69	303,08

Painted version, connection central 50 mm

Model	H mm	L mm	Thermal output				Exp. n	Classification immersion heater Watt	V dm³	M kg	Price RAL 9016 €	Price Cat. 1 €	Price Cat. 2 €
			EN 442 [Ⓞ] Watt	70/55/24 Watt	55/45/24 Watt	55/45/20 Watt							
AB-080-045-05	786	450	344	244	149	179	1,26	300	3,6	5,9	92,74	115,92	189,31
AB-080-050-05	786	500	379	269	164	197	1,26	300	3,9	6,3	96,11	120,14	193,51
AB-120-050-05	1226	500	552	393	240	288	1,26	300	5,7	9,3	119,23	149,05	222,42
AB-150-050-05	1466	500	678	481	293	353	1,27	600	7,2	11,3	136,04	170,05	243,43
AB-180-050-05	1866	500	830	590	360	433	1,26	600	8,7	13,8	156,00	195,01	268,39
AB-120-060-05	1226	600	648	460	281	337	1,26	600	6,6	10,3	128,98	161,24	234,62
AB-150-060-05	1466	600	794	565	346	415	1,25	600	8,2	13,0	149,50	186,88	260,26
AB-180-060-05	1866	600	978	697	427	512	1,25	900	9,9	16,3	173,56	216,95	290,33

Ⓞ Thermal output measured according to EN 442, ΔT 50 K (75/65/20 °C)

Connection to hot water central heating system or for dual energy operation

Chrome-plated version, connection from below

Model	H mm	L mm	Thermal output				Exp. n	Classification Electric heating element Watt	V dm ³	M kg	Price Chrome €
			EN 442① Watt	70/55/24 Watt	55/45/24 Watt	55/45/20 Watt					
ABC-080-050	786	500	277	198	122	146	1,24	-	3,9	6,0	231,59
ABC-120-050	1226	500	403	286	174	209	1,27	300	5,7	9,0	312,88
ABC-150-050	1466	500	483	345	212	254	1,24	300	7,2	11,0	376,17
ABC-180-050	1866	500	606	433	266	319	1,24	600	8,7	14,0	448,71
ABC-080-060	786	600	327	234	144	172	1,24	300	4,6	7,0	260,83
ABC-120-060	1226	600	473	336	205	247	1,26	300	6,6	10,0	352,48
ABC-150-060	1466	600	558	399	245	294	1,24	300	8,2	12,7	428,87
ABC-180-060	1866	600	714	509	312	374	1,25	600	9,9	16,0	511,12

Chrome-plated version, connection central 50 mm

Model	H mm	L mm	Thermal output				Exp. n	Classification Electric heating element Watt	V dm ³	M kg	Price Chrome €
			EN 442① Watt	70/55/24 Watt	55/45/24 Watt	55/45/20 Watt					
ABC-080-050-05	786	500	277	198	122	146	1,24	-	3,9	6,0	252,10
ABC-120-050-05	1226	500	403	286	174	209	1,27	300	5,7	9,0	333,20
ABC-150-050-05	1466	500	483	345	212	254	1,24	300	7,2	11,0	396,38
ABC-180-050-05	1866	500	606	433	266	319	1,24	600	8,7	14,0	468,75
ABC-080-060-05	786	600	327	234	144	172	1,24	300	4,6	7,0	281,23
ABC-120-060-05	1226	600	473	336	205	247	1,26	300	6,6	10,0	372,67
ABC-150-060-05	1466	600	558	399	245	294	1,24	300	8,2	12,7	448,90
ABC-180-060-05	1866	600	714	509	312	374	1,25	600	9,9	16,0	531,00

Electric-only operation with TIMERMEMO

Painted version

Model	H② mm	L③ mm	Classification Electric heating element Watt	Price RAL 9016 €	Price Cat. 1 €	Price Cat. 2 €
ABE-120-050/TF	1276	509	750	325,54	374,36	447,74
ABE-150-060/TF	1516	609	1000	366,87	421,89	495,27

Available in almost any colour and finish from the Zehnder colour chart, see page 31.

Control unit TIMERMEMO in white.

Standard scope of delivery for hot water operation

- Powder coating to DIN 55900, RAL 9016
- 4 x ½" connections for flow, return, air vent and plug
- 1 air vent ½" and 1 blind plug ½"
- Mounting accessories in colour of radiator
- Packaging

Standard scope of delivery for electric operation

- Powder coating to DIN 55900, RAL 9016
- Filled with heat transfer liquid
- With integrated electric heating element and control unit TIMERMEMO in white, right-mounted
- Mounting accessories in colour of radiator
- Packaging

① Thermal output measured according to EN 442, ΔT 50 K (75/65/20 °C)

② Total height incl. immersion heater

③ Total length incl. immersion heater

Zehnder Virando

Hot water operation:
Wall mounting

Wall mounting
centre connections 50 mm

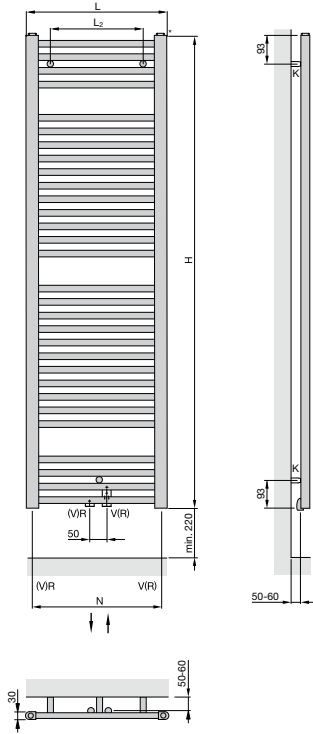
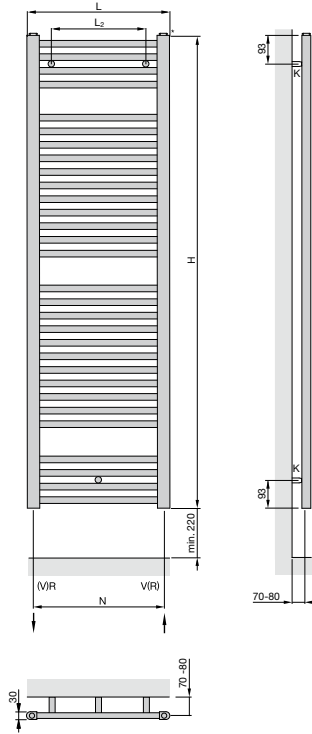

- H = Height
- L = Length
- K = Bracket
- V = Flow 1/2"
- R = Return 1/2"
- N = Boss spacing, L - 44 mm
- L₂ = Length - 150 mm

Dimensions in mm

Zehnder Virando Bow

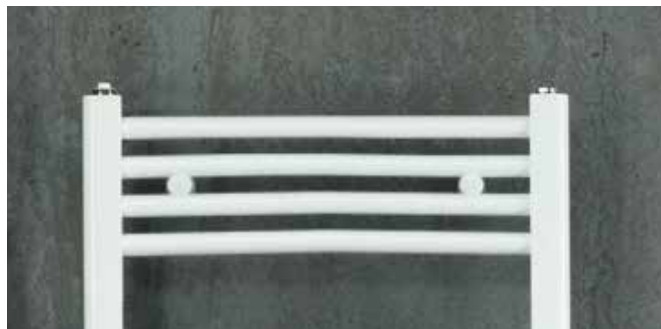

Radiator surface: Ruby Red

Hot water operation

Clarity and class. Zehnder Virando Bow has what any lover of modern style looks for. A clear design, with horizontal and straight tube elements allows for ample space for hanging towels. Zehnder Virando Bow designer radiator made from horizontally arranged precision curved steel tubes with vertical D-profile tubes. Round tubes Ø 23 mm, D-tubes 30 x 40 mm. Available in almost any colour and finish from the Zehnder colour chart. Delivered ready to install with matching wall brackets, packaging.

Benefits

- Timeless design creates an aesthetic accent
- Generous spaces between the tubes convenient for hanging towels
- Top-grade chrome finish
- Ample spaces between tubes make cleaning easy
- Flexible installation due to 50 mm centre connections

Maximum operating pressure
Operating temperature

max. 12 bar
max. 120 °C

Zehnder Virando Bow

Overview of models

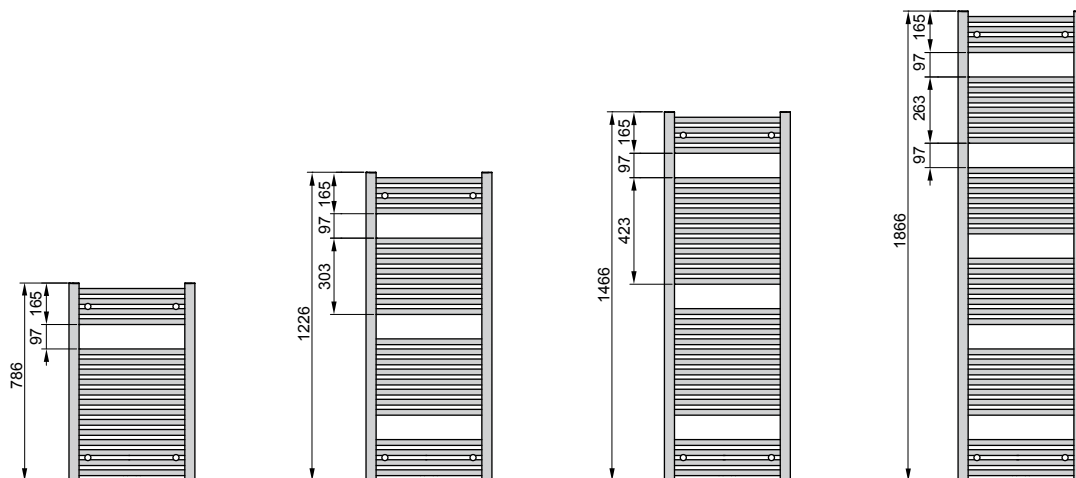

Connection to hot water central heating system or for dual energy operation

Painted version, connection from bottom

Model	H mm	L mm	Thermal output				Exp. n	Classification Electric heating element Watt	V dm ³	M kg	Price RAL 9016 €	Price Cat. 1 €	Price Cat. 2 €
			EN 442① Watt	70/55/24 Watt	55/45/24 Watt	55/45/20 Watt							
ABT-080-050	786	494	398	283	173	208	1,26	300	4,0	6,2	87,06	108,82	182,20
ABT-120-050	1226	494	567	405	248	298	1,25	300	5,9	9,0	109,53	136,92	210,30
ABT-150-050	1466	494	689	491	301	361	1,25	600	7,1	11,1	126,41	158,01	231,40
ABT-180-050	1866	494	828	589	360	433	1,26	600	8,8	13,4	145,86	182,32	255,70
ABT-080-060	786	595	463	331	204	244	1,24	300	4,6	7,1	94,48	118,09	191,48
ABT-120-060	1226	595	658	469	288	345	1,25	600	6,7	10,3	120,21	150,27	223,65
ABT-150-060	1466	595	803	573	351	421	1,25	600	8,1	12,7	139,78	174,73	248,11
ABT-180-060	1866	595	966	687	419	504	1,26	900	10,0	15,4	162,04	202,57	275,94
ABT-120-075	1226	747	799	570	350	419	1,25	600	8,0	12,2	136,13	170,16	243,55
ABT-150-075	1466	747	978	698	428	514	1,25	900	9,7	15,2	160,17	200,21	273,60
ABT-180-075	1866	747	1178	836	509	612	1,27	900	11,8	18,4	186,22	232,79	306,17

Painted version, connection central 50 mm

Model	H mm	L mm	Thermal output				Exp. n	Classification Electric heating element Watt	V dm ³	M kg	Price RAL 9016 €	Price Cat. 1 €	Price Cat. 2 €
			EN 442① Watt	70/55/24 Watt	55/45/24 Watt	55/45/20 Watt							
ABT-080-050-05	786	494	398	283	173	208	1,24	300	4,0	6,5	99,12	123,90	197,29
ABT-120-050-05	1226	494	567	405	248	298	1,25	300	5,9	9,3	121,61	152,01	225,40
ABT-150-050-05	1466	494	689	491	301	361	1,25	600	7,1	11,4	138,50	173,13	246,51
ABT-180-050-05	1866	494	828	589	360	433	1,26	600	8,8	13,7	157,93	197,41	270,79
ABT-080-060-05	786	595	463	331	204	244	1,24	300	4,6	7,4	106,57	133,21	206,59
ABT-120-060-05	1226	595	658	469	288	345	1,25	600	6,7	10,6	132,29	165,37	238,74
ABT-150-060-05	1466	595	803	573	351	421	1,25	600	8,1	13,0	151,86	189,81	263,20
ABT-180-060-05	1866	595	966	687	419	504	1,26	900	10,0	15,7	174,12	217,64	291,02
ABT-120-075-05	1226	747	799	570	350	419	1,25	600	8,0	12,5	148,21	185,27	258,64
ABT-150-075-05	1466	747	978	698	428	514	1,25	900	9,7	15,5	172,25	215,32	288,69
ABT-180-075-05	1866	747	1178	836	509	612	1,27	900	11,8	18,7	198,33	247,90	321,29

① Thermal output measured according to EN 442, ΔT 50 K (75/65/20 °C)

Zehnder Virando Bow

**Connection to hot water central heating system or for dual energy operation**

Chrome-plated version, connection from below

Model	H mm	L mm	Thermal output				Exp. n	Classification Electric heating element Watt	V dm ³	M kg	Price Chrome €
			EN 442 ^① Watt	70/55/24 Watt	55/45/24 Watt	55/45/20 Watt					
ABTC-080-050	786	494	276	196	119	144	1,26	-	4,0	6,2	240,26
ABTC-120-050	1226	494	411	291	177	213	1,27	300	5,9	9,0	320,54
ABTC-150-050	1466	494	485	346	212	254	1,25	300	7,1	11,1	383,90
ABTC-180-050	1866	494	611	435	265	319	1,26	600	8,8	13,4	455,19
ABTC-080-060	786	595	326	231	141	170	1,26	300	4,6	7,1	268,96
ABTC-120-060	1226	595	484	344	209	252	1,26	300	6,7	10,3	361,23
ABTC-150-060	1466	595	572	407	249	299	1,25	300	8,1	12,7	436,19
ABTC-180-060	1866	595	720	512	313	376	1,26	600	10,0	15,4	515,85

Chrome-plated version, connection central 50 mm

Model	H mm	L mm	Thermal output				Exp. n	Classification Electric heating element Watt	V dm ³	M kg	Price Chrome €
			EN 442 ^① Watt	70/55/24 Watt	55/45/24 Watt	55/45/20 Watt					
ABTC-080-050-05	786	494	276	196	119	144	1,26	-	4,0	6,5	261,15
ABTC-120-050-05	1226	494	411	292	178	214	1,26	300	5,9	9,3	341,40
ABTC-150-050-05	1466	494	485	346	212	254	1,25	300	7,1	11,4	404,77
ABTC-180-050-05	1866	494	611	435	265	319	1,26	600	8,8	13,7	474,46
ABTC-080-060-05	786	595	326	231	141	170	1,26	300	4,6	7,4	289,86
ABTC-120-060-05	1226	595	484	344	209	252	1,26	300	6,7	10,6	382,11
ABTC-150-060-05	1466	595	572	407	249	299	1,25	300	8,1	13,0	457,08
ABTC-180-060-05	1866	595	720	513	314	377	1,25	600	10,0	15,7	536,72

Standard scope of delivery for hot water operation

- Powder coating to DIN 55900, RAL 9016
- 4 x ½" connections for flow, return, air vent and plug
- 1 air vent ½" and 1 blind plug ½"
- Mounting accessories in colour of radiator
- Packaging

① Thermal output measured according to EN 442, ΔT 50 K (75/65/20 °C)

Zehnder Virando Bow

Hot water operation:
Wall mounting

Wall mounting
centre connections 50 mm

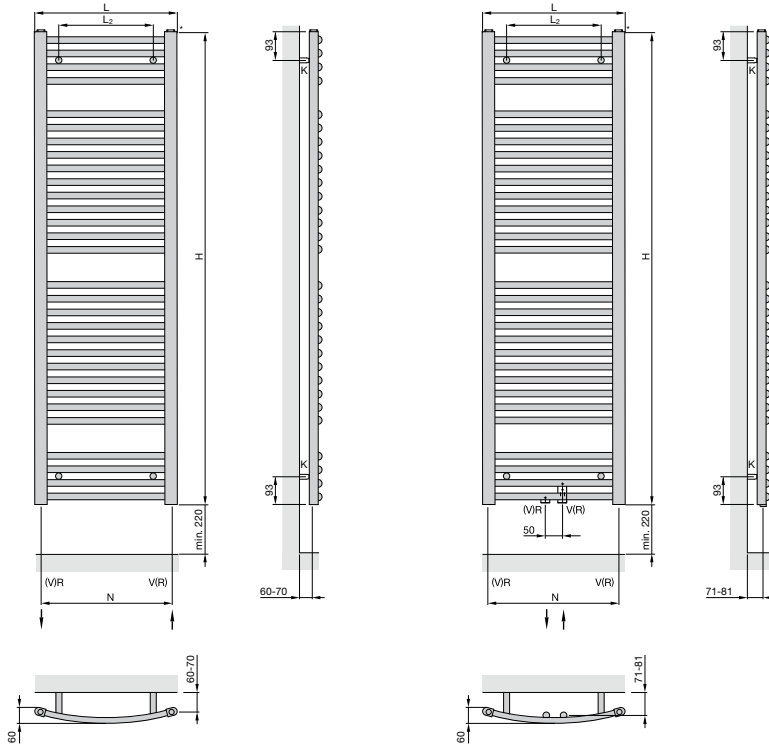

- H = Height
- L = Length
- K = Bracket
- V = Flow 1/2"
- R = Return 1/2"
- N = Boss spacing, L - 44 mm
- L₂ = Length - 150 mm

Dimensions in mm

Zehnder Impa

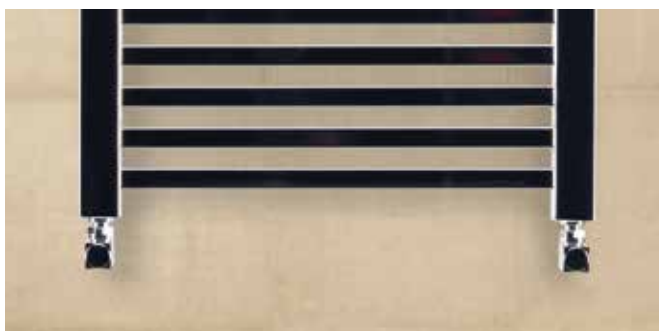

Radiator surface: Chrome

Operation on hot water central heating system

Zehnder Impa stands out because of its subtle elegance and practical functionality. The geometric design with the square tube elements is a perfect fit for any bathroom. The generous clearance between the sets of tubes makes hanging and warming towels easy. The radiator is available in white and with a high-quality chrome finish.

Benefits

- Timeless design with square headers is ideal for classic bathrooms
- Small radiator depth ideal for narrow rooms
- Easy cleaning with the lambswool cleaning brush from Zehnder
- Generous spaces between the tubes convenient for hanging towels

Standard scope of delivery

- Powder coating to DIN 55900, RAL 9016
- 4 x 1/2" connections for flow/ return, air vents
- 1 x blind plug 1/2"
- 1 x air vent 1/2"
- Accessories in colour of radiator
- Packaging

Maximum operating pressure	max. 13,0 bar
Operating temperature	max. 90 °C
Height mm
Length mm
Model

Zehnder Impa

Overview of models

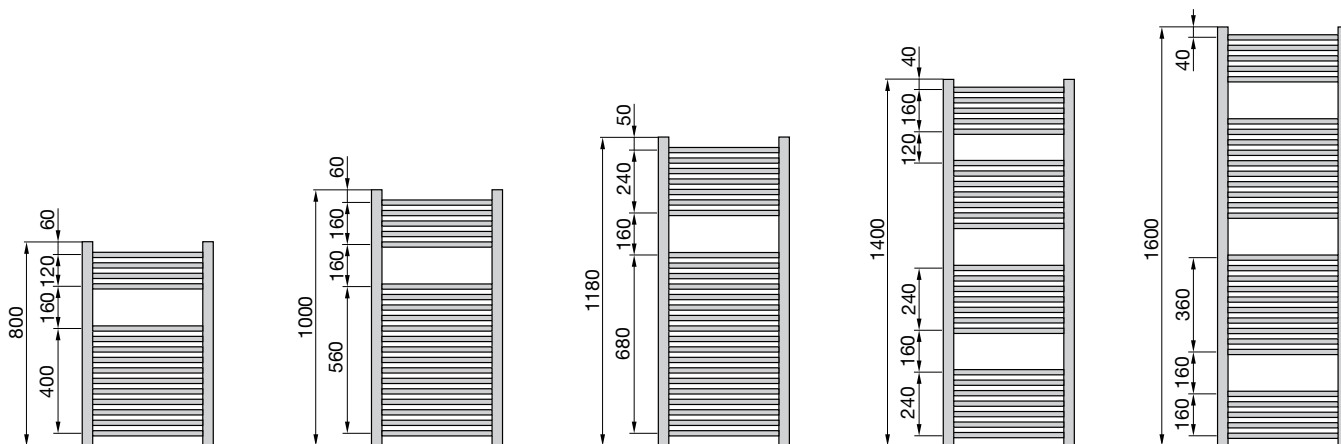

Connection to hot water central heating system or for dual energy operation

Minimum quantity per order:
10 pcs

Painted version

Model	H mm	L mm	Thermal output				Exp. n	Classification Electric heating element Watt	V dm ³	M kg	Price RAL 9016 €
			EN 442 ³ Watt	70/55/24 Watt	55/45/24 Watt	55/45/20 Watt					
IMP-080-050	800	500	364	262	163	194	1,22	300	4,2	7,3	261,67
IMP-100-050	1000	500	460	330	203	244	1,23	300	5,4	9,5	291,17
IMP-120-050	1180	500	548	392	241	289	1,24	300	6,5	11,5	335,27
IMP-140-050	1400	500	636	453	278	333	1,25	600	7,4	13,0	349,57
IMP-160-050	1600	500	717	510	311	374	1,26	600	8,3	14,5	363,90

Chrome-plated version

Model	H mm	L mm	Thermal output				Exp. n	Classification Electric heating element Watt	V dm ³	M kg	Price Chrome €
			EN 442 ³ Watt	70/55/24 Watt	55/45/24 Watt	55/45/20 Watt					
IMPC-080-050	800	500	214	152	93	112	1,26	-	4,2	7,2	391,92
IMPC-100-050	1000	500	272	193	117	141	1,27	-	5,4	9,3	457,93
IMPC-120-050	1180	500	323	228	138	167	1,28	300	6,5	11,3	526,85
IMPC-140-050	1400	500	387	273	164	199	1,29	300	7,4	12,8	605,40
IMPC-160-050	1600	500	445	313	188	227	1,30	300	8,3	14,1	670,53

© Thermal output measured according to EN 442, ΔT 50 K (75/65/20 °C)

Zehnder Impa



**Connection to hot water central heating system:
Wall mounting**

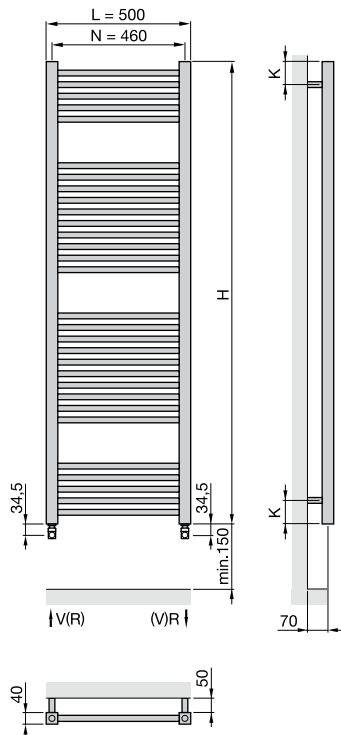

- H = Height
- L = Length
- K = Bracket (H800/H1000=100;
H1180=90; H1400/H1600=80)
- V = Flow 1/2"
- R = Return 1/2"
- N = Boss spacing

Dimensions in mm

Accessories (surcharge)	Article number	Price €
<ul style="list-style-type: none"> ■ Electric heating element for dual energy operation 	-	see page 161
<ul style="list-style-type: none"> ■ Valve type W: square-shaped, chrome, angled, lockshield with manual handwheel incl. 2 pcs. 3/4" Eurocone nuts 16,8 mm in finish of valve body, without adaptors for pipes 	839198	220,83

Zehnder Zeta



Radiator colour: Anthrazite



Radiator surface: Chrome



Connecting to hot water central heating system

Subtle elegance and clear lines. With the flat design of its horizontal tube elements 60 x 9 mm, Zehnder Zeta combines form and function in the bathroom. The generous clearance between the sets of tubes makes hanging and warming towels easy. The radiator is available in white and with a quality chrome finish.

Maximum operating pressure	max. 4,0 bar
Operating temperature	max. 90 °C
Height mm
Length mm
Model

Benefits

- Radiator with flat design
- Flexible installation through right and left connection options

Standard scope of delivery

- Powder coating to DIN 55900, RAL 9016
- 4 x ½" connections for flow/ return, air vents
- 1 x blind plug ½"
- 1 x air vent ½"
- Accessories in colour of radiator
- Packaging

Zehnder Zeta



Overview of models

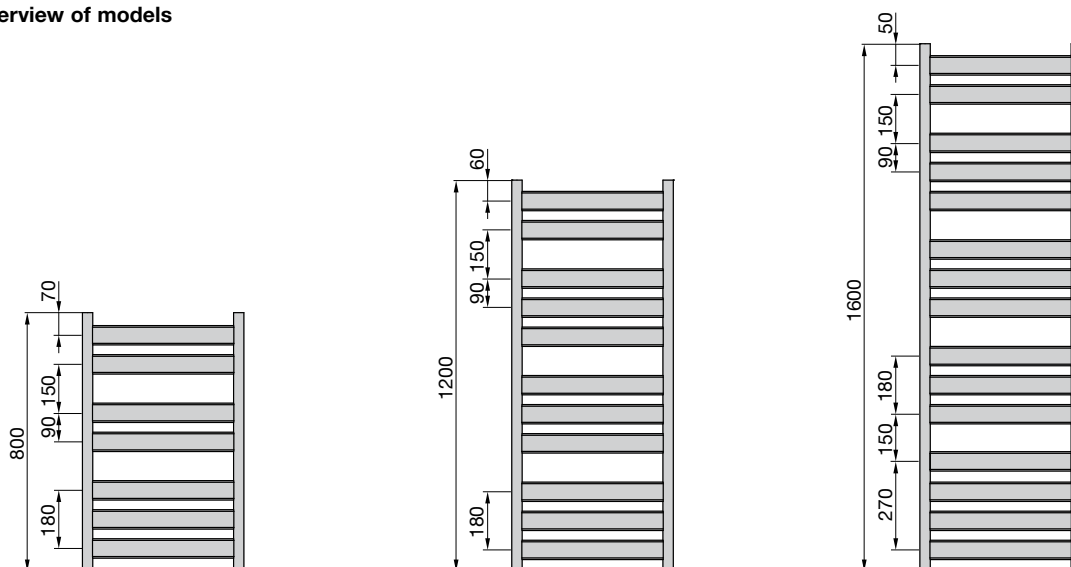

Connection to hot water central heating system

Minimum quantity per order: 10 pcs

Painted version (White RAL 9016)

Model	H mm	L mm	Thermal output				Exp. n	Classification Electric heating element Watt	V dm ³	M kg	Price RAL 9016 €
			EN 442 ^③ Watt	70/55/24 Watt	55/45/24 Watt	55/45/20 Watt					
ZET-080-050	800	500	322	230	141	170	1,24	300	2,2	6,4	263,43
ZET-120-050	1200	500	476	340	209	253	1,24	300	3,7	10,1	335,27
ZET-160-050	1600	500	647	463	285	340	1,23	600	4,6	13,3	423,58
ZET-080-060	800	600	377	271	168	201	1,22	300	2,6	7,4	279,88
ZET-120-060	1200	600	566	405	249	298	1,22	300	4,4	11,3	360,73
ZET-160-060	1600	600	746	533	328	397	1,23	600	5,5	15,3	463,97

Painted version (Anthracite RAL 0346)

Model	H mm	L mm	Thermal output				Exp. n	Classification Electric heating element Watt	V dm ³	M kg	Price Anthracite €
			EN 442 ^③ Watt	70/55/24 Watt	55/45/24 Watt	55/45/20 Watt					
ZET-120-050-0346	1200	500	476	340	209	253	1,24	300	3,7	10,1	368,98
ZET-120-060-0346	1200	600	566	405	249	298	1,22	300	4,4	11,3	397,48
ZET-160-060-0346	1600	600	746	533	328	397	1,23	600	5,5	15,3	510,00

Chrome-plated version

Model	H mm	L mm	Thermal output				Exp. n	Classification Electric heating element Watt	V dm ³	M kg	Price Chrome €
			EN 442 ^③ Watt	70/55/24 Watt	55/45/24 Watt	55/45/20 Watt					
ZETC-080-050	800	500	203	144	88	106	1,26	-	2,2	6,4	428,05
ZETC-120-050	1200	500	303	214	130	156	1,28	300	3,7	10,0	526,86
ZETC-160-050	1600	500	394	279	169	205	1,27	300	4,6	13,2	670,53
ZETC-080-060	800	600	235	168	103	123	1,25	-	2,6	7,4	453,51
ZETC-120-060	1200	600	353	250	151	183	1,27	300	4,4	11,4	571,74
ZETC-160-060	1600	600	457	322	194	237	1,28	300	5,5	15,3	727,39

③ Thermal output measured according to EN 442, ΔT 50 K (75/65/20 °C)

Zehnder Zeta

Operation on hot water central heating system:
Wall mounting

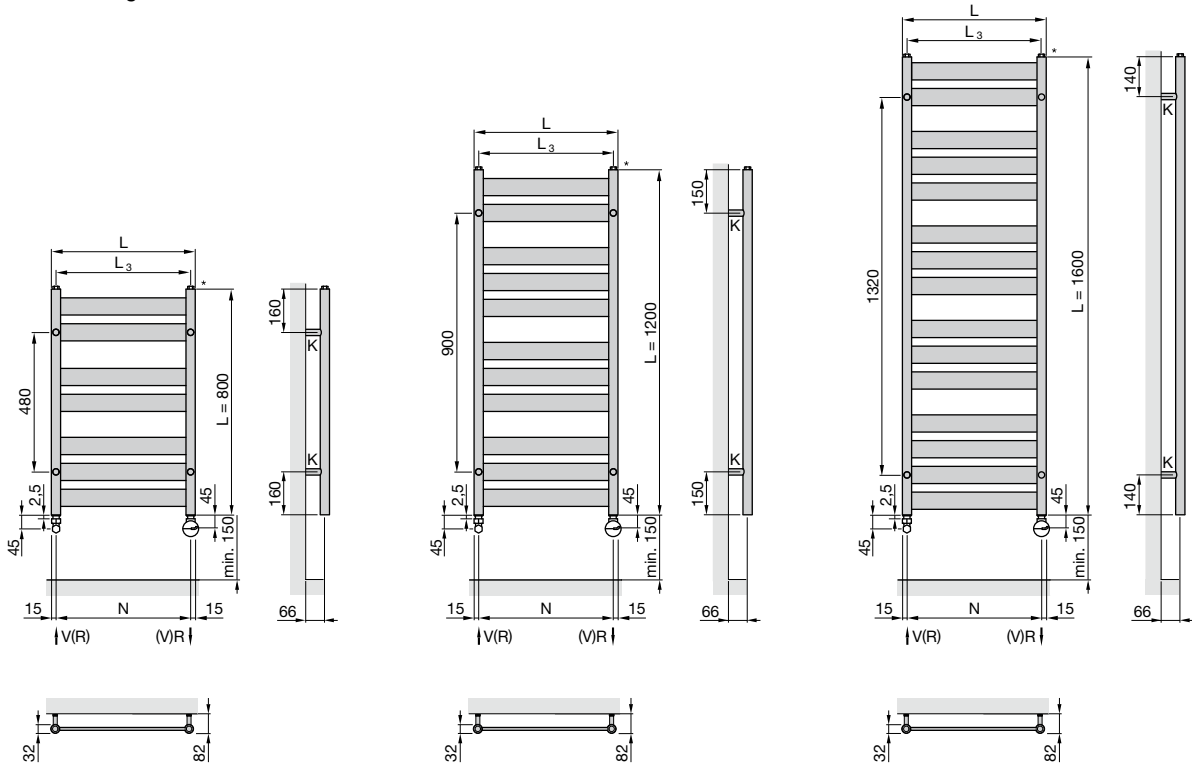

- H = Height
- L = Length
- K = Bracket
- V = Flow ½"
- R = Return ½"
- N = Boss spacing, L - 32 mm
- L₃ = Length - 32 mm

Dimensions in mm

Accessories (surcharge)	Article number	Price €
■ Electric heating element for dual energy operation	-	see page 161
■ Zehnder valves, lockshield valves and connection fittings	-	See p. 165 onwards
■ Zehnder thermostats	-	See page 164

A large, empty grid of small squares occupies the central portion of the page, intended for taking notes. The grid is composed of approximately 30 columns and 50 rows of squares.

A large, empty grid of small squares occupies the central portion of the page, intended for taking notes. The grid is composed of approximately 25 columns and 40 rows of squares.

ACCESSORIES AND GENERAL INFORMATION

Accessories
and general
information

from page 150

Zehnder retrofit radiators

- The right model for any retrofitting situation
- Cut-outs and towel rails for hanging and heating towels
- Side connections for easy replacement of old DIN standard radiators
- Convenient operating height of the thermostat due to side connections (accessible)
- Connection options guarantee short installation times for renovations

For more information, see the relevant product sections



Zehnder Charleston Bar



Zehnder Metropolitan Bar



Zehnder Toga

Zehnder room dividers



Zehnder Yucca Asym
For room divider mounting set, see following pages







Zehnder Toga
For room divider mounting set, see following pages



Zehnder Subway
For room divider version, see Zehnder Subway product pages

Room divider mounting sets





Description		Version	Article number	Price €	Application
Room divider mounting set 2 wall brackets with clamp jaws; cover for wall panel incl. screws and anchors; directional air vents (½"); installation instructions; for wall clearance 80 mm		Standard finish Special finish Chrome-plated	936011 936019 936018	221,50 267,35 292,33	Zehnder Yucca Asym
Room divider mounting set without foot support 2 wall brackets comprising wall sleeve (38 mm); sliding part; clamp for D-profile; directional air vent (¼"); fixings; installation instructions; for wall clearance 53 mm		Standard finish Special finish Chrome-plated	931111 931119 931118	131,21 159,53 152,50	Zehnder Toga
Room divider mounting set with foot support 2 wall brackets comprising wall sleeve (38 mm); sliding part; clamp for D-profile; floor sleeve (60 mm); spacer (M 10 x 125); fixings; installation instructions; for wall clearance 53 mm		Standard finish Special finish Chrome-plated	931141 931149 931148	159,53 187,93 180,86	Zehnder Toga electric operation
Room divider mounting set, long, without foot support 2 wall brackets comprising wall sleeve (88 mm); sliding part; clamp for D-profile; directional air vent (¼"); fixings; installation instructions; for wall clearance 103 mm		Standard finish Special finish Chrome-plated	931211 931219 931218	170,58 197,87 189,56	Zehnder Toga
Room divider mounting set, long, with foot support 2 wall brackets comprising wall sleeve (88 mm); sliding part; clamp for D-profile; directional air vent ¼"; floor sleeve (60 mm); distance piece; M 10 x 125; fixings; installation instructions; for wall clearance 103 mm		Standard finish Special finish Chrome-plated	931241 931249 931248	198,95 226,21 217,88	Zehnder Toga electric operation

Room divider mounting sets





Mounting sets for repeat ordering

Description	Version	Article number	Price €	Application
<p>Room divider mounting set with foot support* 2 wall brackets comprising wall sleeve (38 mm) and clamp; 1 floor sleeve (50 mm); 1 spacer (M 10 x 125 mm); 1 decorative directional air vent (½"); 1 blanking plug (½"), chrome-plated, fixings; installation instructions; for wall clearance 53 mm</p> <p>* Only for post-ordering, as contained in scope of delivery when ordering the Zehnder Subway and Zehnder Quaro as a room divider model. Due to welded-on threaded bolts, the standard version of the radiator is not suitable for room divider installation.</p>	<p>Standard finish Special finish Chrome-plated</p>	<p>931151 931159 931158</p>	<p>159,53 187,93 180,86</p>	Zehnder Subway, Zehnder Quaro (each available as room divider version)
<p>Separate foot support, for room divider installation 150 mm for floor clearance 150-170 mm; 1 floor sleeve (60 mm); 1 spacer (M 10 x 125 mm); 1 blind hole plug (½"xM10); fixings</p>	<p>Standard finish Special finish Chrome-plated</p>	<p>931301 931309 931308</p>	<p>48,28 72,39 71,13</p>	
<p>Mounting set 4 wall brackets comprising wall sleeves 40 mm with threaded pin M6; 4 plastic plugs 10 x 50 mm; 4 phillips screws 6 x 60 mm, galvanized; 2 directional air vents ½", chrome plated; 2 air vent covers, plastic chrome-plated; 1 hexagonal-wrench SW 3 mm</p>	<p>Chrome-plated</p>	<p>950380</p>	<p>74,53</p>	Zehnder Alban
<p>Mounting set 3 painted wall brackets with 2 threaded pins M6 each; 3 plastic plugs 8 x 40 mm; 4 hexagonal screws with slot 6 x 50 mm, galvanized; 3 spacers; 1 directional air vent ¼"; 1 hexagonal wrench SW 3 mm</p>	<p>Standard finish Special finish Chrome-plated</p>	<p>962361 962369 962368</p>	<p>80,14 140,24 149,07</p>	Zehnder Archibald
<p>Mounting set 4 wall brackets comprising wall sleeves 40 mm with threaded pin M6; 4 plastic plugs 10 x 50 mm; 4 phillips screws 6 x 60 mm, galvanized; 2 directional air vents ½", chrome-plated; 2 air vent covers, plastic chrome-plated; 1 hexagonal wrench SW 3 mm</p>	<p>Chrome-plated</p>	<p>950390</p>	<p>74,53</p>	Zehnder Chime
<p>Mounting set 4 wall brackets comprising wall sleeves (80 mm) with threaded pin, spacer piece with thread and lock screw 6 x 20 mm, galvanized; 4 plastic plugs 8 x 40 mm; 4 hexagonal screws with slot 6 x 50 mm, galvanized; 4 washers, galvanized; 1 spacer screw hexagon 10 x 70 mm, galvanized; plastic cap hexagon 10 x 19 mm black; locking nut M10; galvanized; 1 hexagonal wrench SW 2,5 mm</p>	<p>White Black</p>	<p>950331 950339</p>	<p>122,66 122,66</p>	Zehnder Deseo Verso
<p>Mounting set 4 wall brackets comprising wall sleeves (40 mm) with threaded pin M5, spacer piece with thread and lock screw 6 x 20 mm, galvanized; 4 plastic plugs 10 x 50 mm; 4 hexagonal screws with slot 6 x 60 mm, galvanized; 1 hexagonal spacer screw 10 x 40 mm, galvanized; 1 hexagonal plastic cap 10 x 10 mm, black; 1 locking nut M10, galvanized; 1 hexagonal wrench SW 2,5 mm</p>	<p>White Black</p>	<p>950251 950259</p>	<p>122,66 122,66</p>	Zehnder Folio Glass









Mounting sets for repeat ordering

Description		Version	Article number	Price €	Application
<p>Mounting set 4 wall brackets comprising wall sleeve (60 mm) with threaded pin; combination spacer (54 mm) and clamp; 4 plastic anchors 10 x 70 mm; 4 hexagonal screws with slot 6 x 80 mm, galvanised; 4 washers, galvanised; 1 Allen key (SW 2,5 mm); 2 directional air vents ½"; installation instructions</p>		Standard finish Special finish Chrome-plated	935011 935019 935018	113,46 183,98 254,52	Zehnder Yucca, Zehnder Yucca Asym
<p>Mounting set 4 wall brackets comprising wall sleeve (60 mm) with threaded pin; combination distance piece (54 mm) and clamp; 4 plastic anchors 10 x 70 mm; 4 hexagonal screws with slot 6 x 80 mm, galvanised; 4 washers, galvanised; 1 Allen key SW 2,5 mm; installation instructions</p>		Standard finish Special finish Chrome-plated	962891 962899 962898	100,16 170,70 241,20	Zehnder Yucca electric operation with Immersion heater RACY
<p>Mounting set 4 wall brackets comprising wall sleeve (60 mm) with threaded pin; 4 spacers with thread; 4 plastic anchors (8 x 40 mm); 4 hexagonal screws with slot (6 x 50 mm), galvanised; 4 washers, galvanised; 1 Allen key SW 2,5 mm; 1 decorative directional air vent (½"); installation instructions</p>		Standard finish Special finish	962161 962169	97,63 129,06	Zehnder Vitalo Bar, Zehnder Folio Belt / Folio Hybrid
<p>Mounting set 1 wall bracket comprising wall sleeve (60 mm) with threaded pin; 1 spacer with thread; 1 chain with 2 chain fasteners; 5 plastic anchors (8 x 40 mm); 5 hexagonal screws with slot (6 x 50 mm), galvanised; 5 washers, galvanised; 1 Allen key SW 2,5 mm; 1 decorative directional air vent (½"); installation instructions</p>		Standard finish Special finish	962171 962179	97,63 129,06	Zehnder Vitalo Bar with EasyFit connection box
<p>Mounting set 4 wall brackets comprising wall sleeve (60 mm) with threaded pin; 4 spacers with thread; 4 plastic anchors (8 x 40 mm); 4 hexagonal screws with slot (6 x 50 mm), galvanised; 4 washers, galvanised; 1 Allen key (SW 2,5 mm); installation instructions</p>		Standard finish Special finish	962181 962189	97,63 129,06	Zehnder Vitalo Bar electric operation

Mounting sets for repeat ordering





Description		Version	Article number	Price €	Application
Mounting set 4 wall brackets CVD0; 4 brackets BH; 2 retaining springs; installation instructions		Standard finish Special finish	774401 774409	24,95 65,68	Zehnder Charleston Bar
Mounting set 4 wall brackets comprising wall sleeve (40 mm) with threaded pin, spacer (32 mm); 4 plastic anchors (8 x 40 mm); 4 hexagonal screws with slot (6 x 50 mm), galvanised; 4 washers, galvanised; 1 Allen key (SW 2,5 mm); 1 decorative directional air vent (½"); 2 blanking plugs (½"), chrome-plated; 1 vent tool; installation instructions		Standard finish Special finish	962071 962079	113,46 183,98	Zehnder Metropolitan Spa / Bar (can also be used for dual energy operation)
Mounting set 4 wall brackets comprising wall sleeve (40 mm) with threaded pin, distance piece (32 mm); 4 plastic anchors 8 x 40 mm; 4 hexagonal screws with slot 6 x 50 mm, galvanised; 4 washers, galvanised; 1 Allen key SW 2,5 mm; installation instructions		Standard finish Special finish	962081 962089	100,16 170,70	Zehnder Metropolitan Spa / Bar electric operation
Mounting set 2 wall brackets AKPS (with anti-lifting); 2 wall brackets AKP; 4 sound insulation parts; 8 plastic plugs 8 x 40 mm, 8 hexagonal screws 6 x 50 mm, galvanised; air vent ½", air vent key, installation instruction		Standard finish Special finish	963121 963129	139,00 145,95	Zehnder Fina Lean Bar
Mounting set 2 wall brackets AKPS (with anti-lifting); 2 wall brackets AKP; 4 sound insulation parts; 8 plastic plugs 8 x 40 mm, 8 hexagonal screws 6 x 50 mm, galvanised; installation instruction		Standard finish Special finish	963131 963139	139,00 145,95	Zehnder Fina Lean Bar electric operation

Mounting sets for repeat ordering

Description		Version	Article number	Price €	Application
Mounting set 4 wall brackets comprising wall sleeve (60 mm) with threaded pin, spacer (32 mm); 4 plastic anchors 8 x 40 mm; 4 hexagonal screws with slot (6 x 50 mm), galvanised; 4 washers, galvanised; 1 Allen key SW 2,5 mm; 1 directional air vent ½"; 2 blanking plugs ½"; installation instructions		Standard finish Special finish Chrome-plated	923191 923199 923198	116,10 188,22 265,41	Zehnder Kazeane
Mounting set 4 wall brackets comprising wall sleeve (60 mm) with threaded pin, spacer (32 mm); 4 plastic anchors 8 x 40 mm; 4 hexagonal screws with slot (6 x 50 mm), galvanised; 4 washers, galvanised; 1 Allen key SW 2,5 mm; installation instructions		Standard finish Special finish Chrome-plated	950281 950289 950288	100,16 170,70 241,20	Zehnder Kazeane electric operation
Mounting set 4 wall brackets comprising wall sleeve (50 mm) with threaded pin; spacer with thread (M12); 4 plastic anchors (8 x 40 mm); 4 hexagonal screws with slot (6 x 40 mm), galvanised; 4 washers, galvanised; installation instructions		Standard finish Special finish	962671 962679	102,05 173,90	Zehnder Roda Spa Asym
Mounting set 4 wall sleeves (60 mm); 4 socket screws (4 x 20 mm); 4 plastic anchors (8 x 40 mm); 4 hexagonal screws with slot (6 x 80 mm), galvanised; 4 washers, galvanised; 1 Allen key (SW 3 mm); 1 decorative directional air vent (½"); 2 blanking plugs (½"), chrome-plated; 1 vent tool; installation instructions		Standard finish Special finish Chrome-plated Stainless steel	952201 952209 952208 952200	118,49 192,08 265,73 265,73	Zehnder Quaro
Mounting set 4 wall sleeves (60 mm); 4 socket screws (4 x 20 mm); 4 plastic anchors (8 x 40 mm); 4 hexagonal screws with slot (6 x 80 mm), galvanised; 4 washers, galvanised; 1 Allen key (SW 3 mm); installation instructions		Standard finish Special finish Chrome-plated	952211 952219 952218	104,59 178,26 251,83	Zehnder Quaro electric operation
Mounting set 4 wall brackets comprising wall sleeve (40 mm) with threaded pin, spacer (32 mm); 4 plastic anchors (8 x 40 mm); 4 hexagonal screws with slot (6 x 50 mm), galvanised; 4 washers, galvanised; 1 Allen key (SW 2,5 mm); 1 decorative directional air vent (½"); 2 blanking plugs (½"), chrome-plated; 1 vent tool; installation instructions		Standard finish Special finish Chrome-plated	952101 952109 952108	113,46 183,98 254,52	Zehnder Subway
Mounting set 4 wall brackets comprising wall sleeve (40 mm) with threaded pin, distance piece (32 mm); 4 plastic anchors 8 x 40 mm; 4 hexagonal screws with slot 6 x 50 mm, galvanised; 4 washers, galvanised; 1 Allen key SW 2,5 mm; installation instructions		Standard finish Special finish Chrome-plated	954101 954109 954108	100,16 170,70 241,20	Zehnder Subway electric operation
Mounting set 4 wall brackets* comprising wall sleeve (60 mm) with threaded pin, spacer (32 mm); 4 plastic anchors (8 x 40 mm); 4 hexagonal screws with slot (6 x 50 mm), galvanised; 4 washers, galvanised; 1 Allen key (SW 2,5 mm); 1 decorative directional air vent (½"); 2 blanking plugs (½"), chrome-plated; 1 vent tool; installation instructions		Standard finish Special finish Chrome-plated	952111 952119 952118	113,46 183,98 254,52	Zehnder Subway (with extended wall clearance)
Mounting set 4 wall brackets* comprising wall sleeve (60 mm) with threaded pin, spacer (32 mm); 4 plastic anchors 8 x 40 mm; 4 hexagonal screws with slot 6 x 50 mm, galvanised; 4 washers, galvanised; 1 Allen key SW 2,5 mm; installation instructions		Standard finish Special finish Chrome-plated	954111 954119 954118	100,16 170,70 241,20	Zehnder Subway electric operation (with extended wall clearance)



* for mounting with extended wall clearance

Mounting sets for repeat ordering

Description		Version	Article number	Price €	Application
<p>Mounting set 3 wall brackets comprising wall sleeve (60 mm) with threaded pin; combination spacer (40 mm) and clamp; 3 plastic anchors (8 x 40 mm); 3 hexagonal screws with slot (6 x 50 mm), galvanised; 3 washers, galvanised; 1 Allen key (SW 2,5 mm); 1 directional air vent (¼"); installation instructions</p>		Standard finish Special finish Chrome-plated	926021 926029 926028	70,83 124,33 131,71	Zehnder Toga ¹⁾
<p>Mounting set 3 wall brackets comprising wall sleeve (60 mm) with threaded pin; combination spacer (40 mm) and clamp; 3 plastic anchors (8 x 40 mm); 3 hexagonal screws with slot (6 x 50 mm), galvanised; 3 washers, galvanised; 1 Allen key (SW 2,5 mm); installation instructions</p>		Standard finish Special finish Chrome-plated	925021 925029 925028	70,83 124,33 131,71	Zehnder Toga electric operation
<p>Mounting set 4 wall brackets comprising wall sleeve (60 mm) with threaded pin; combination spacer (40 mm) and clamp; 4 plastic anchors (8 x 40 mm); 4 hexagonal screws with slot (6 x 50 mm), galvanised; 4 washers, galvanised; 1 Allen key (SW 2,5 mm); 1 directional air vent (½"); installation instructions</p>		Standard finish Special finish	923131 923139	97,99 209,62	Zehnder Forma Asym ¹⁾
<p>Mounting set 4 wall brackets comprising wall sleeve (80 mm) with threaded pin; combination spacer (40 mm) and clamp; 4 plastic anchors (8 x 40 mm); 4 hexagonal screws with slot (6 x 50 mm), galvanised; 4 washers, galvanised; 1 Allen key (SW 2,5 mm); installation instructions</p>		Standard finish Special finish	950291 950299	97,99 209,62	Zehnder Forma Asym electric operation

¹⁾ In the case of radiators with centre connections, the original scope of delivery includes two additional blanking plugs.

Mounting sets for repeat ordering

Description		Version	Article number	Price €	Application
Mounting set 4 wall brackets comprising wall sleeve (60 mm) with threaded pin; combination spacer (40 mm) and clamp; 4 plastic anchors (8 x 40 mm); 4 hexagonal screws with slot (6 x 50 mm), galvanised; 4 washers, galvanised; 1 Allen key (SW 2,5 mm); 1 directional air vent (½"); installation instructions		Standard finish Special finish Chrome-plated Stainless steel	923021 923029 923028 923060	96,18 205,75 217,98 217,98	Zehnder Forma Spa
Mounting set 4 wall brackets comprising wall sleeve (50 mm) with threaded pin; 4 spacers (25 mm) with thread; 4 plastic anchors (8 x 40 mm); 4 hexagonal screws (10 x 45 mm), galvanised; 4 washers, galvanised; directional air vent (½"); blanking plug (½"); installation instructions		Standard finish Special finish	923041 923049	59,11 118,22	Zehnder Forma Spa double-layer
Mounting set 4 wall brackets comprising wall sleeve (60 mm) with threaded pin; combination spacer (40 mm) and clamp; 4 plastic anchors (8 x 40 mm); 4 hexagonal screws with slot 6 x 50 mm, galvanised; 4 washers, galvanised; 1 Allen key (SW 2,5 mm); installation instructions		Standard finish Special finish Chrome-plated	923031 923039 923038	96,18 205,75 217,98	Zehnder Forma Spa electric operation
Mounting set 3 wall brackets comprising wall sleeve (60 mm) with threaded pin; 3 spacers with thread; 3 plastic anchors (8 x 40 mm); 3 hexagonal screws (5,5 x 50 mm), galvanised; 3 washers, galvanised; 1 Allen key (SW 2,5 mm); 1 air vent 1/2"; 1 blanking plug ½"; installation instructions	Without illustration	Standard colour Special colour Chrome-plated	926271 926279 926278	134,90 173,76 203,66	Zehnder Klaro
Mounting set 3 wall brackets comprising wall sleeve (60 mm) with threaded pin; 3 spacers with thread; 3 plastic anchors (8 x 40 mm); 3 hexagonal screws (5,5 x 50 mm), galvanised; 3 washers, galvanised; 1 Allen key (SW 2,5 mm); installation instructions	Without illustration	Standard colour Special colour Chrome-plated	926291 926299 926298	132,04 164,94 197,38	Zehnder Klaro electric
Mounting set 4 wall brackets comprising wall sleeve (40 mm) with threaded pin, distance piece (32 mm); 4 plastic anchors 8 x 40 mm; 4 hexagonal screws with slot 6 x 50 mm, galvanised; 4 washers, galvanised; 1 Allen key SW 2,5 mm; 1 air vent ½"; 1 blanking plug ½", chrome-plated; 1 venting key	Without illustration	Chrome-plated	928052	248,28	Zehnder Stalox







¹⁾ In the case of radiators with centre connections, the original scope of delivery includes two additional blanking plugs.

Mounting sets for repeat ordering

Description	Version	Article number	Price €	Application	
Mounting set 4 wall brackets comprising wall sleeve with fixing screws and cover; 4 distance pieces; 4 plastic anchors; 4 screws 5,5 x 50 mm, 4 washers, 1 air vent ½", 1 blanking plug ½"	Without illustration	White (straight version)	926511	44,49	Zehnder Aura
		White (curved version)	926521	56,96	
		Chrome (straight version)	926518	67,32	
		Chrome (curved version)	926528	83,62	
Mounting set 3 wall brackets comprising wall sleeve with 3 plastic anchors 8 x 40 mm; 3 hexagonal screws 5,5 x 50 mm, galvanised; 3 washers, galvanised; 1 Allen key for M5; 1 blind plug	Without illustration	White	926281	38,13	Zehnder Aura electric
		Chrome	926288	54,58	
		Black matt	926289	45,17	
Extension set for wall brackets consisting of 2 wall sleeves (80 mm) for installation for extended wall clearance; incl. screws and anchors Application: compensating for a recess in the wall (e.g. tile edge)		Standard finish	782061	41,87	Vitalo Bar, Toga, Forma Asym / Spa (single-layer)
		Special finish	782069	57,37	
		Chrome-plated	782068	60,81	
Mounting set 4 wall mounting brackets; 4 wall mounting screws 6,3 x 60 mm; 4 wall plugs 10 x 50 mm; 4 set screws; 1 blind plug and 1 air vent	Without illustration	Stainless steel	950309	41,69	Zehnder Bluebell
Mounting set 4 wall brackets with threaded pin; 4 plastic anchors; 4 screws 5,5 x 50 mm, 4 washers; 1 air vent ½", 1 blanking plug ½"; 1 Allen key 2,5 mm	Without illustration	White	926281	33,31	Zehnder Virando
		Chrome-plated	926288	47,68	
		Cat.1 and 2	926289	39,45	
Mounting set 4 wall brackets with threaded pin; 4 plastic anchors; 4 screws 5,5 x 50 mm, 4 washers; 1 air vent ½", 1 blanking plug ½"; 1 Allen key 2,5 mm	Without illustration	White	926191	37,37	Zehnder Virando Bow
		Cat.1 and 2	926199	44,40	
Mounting set 4 wall brackets with threaded pin; 4 plastic anchors; 4 screws 5,5 x 50 mm, 4 washers; 1 air vent ½", 1 blanking plug ½"; 1 Allen key 2,5 mm	Without illustration	White	926731	54,85	Zehnder Impa
		Chrome-plated	926738	62,70	
Mounting set 4 wall brackets with threaded pin; 4 plastic anchors; 4 screws 5,5 x 50 mm, 4 washers; 1 air vent ½", 1 blanking plug ½"; 1 Allen key 2,5 mm	Without illustration	White	926681	38,86	Zehnder Zeta
		Anthracite	926680	40,69	
		Chrome-plated	926688	58,81	

¹⁾ In the case of radiators with centre connections, the original scope of delivery includes two additional blanking plugs.

Comfort accessories



Description		Length in mm ¹⁾	Article number	Price €	Application
Towel rail High-quality towel rail in stainless steel. For subsequent assembly in any height. Rectangular version 30 x 4 mm.		342 [305]	468002	214,06	Arteplano
		490 [453]	468012	228,32	
		638 [601]	468022	242,58	
Towel rail High-quality towel rail in steel, chrome plated. For subsequent assembly in fixed position.		490 [441]	468438	242,58	Folio Glass
		590 [540]	468448	256,85	
Towel rail High-quality towel rail in brass, chrome-plated, with concealed attachment for asymmetric (max. 395 mm) or symmetric installation; max. load 5 kg (asym.) or 10 kg (sym.)		295 [400]	468038	156,06	Metropolitan Spa / Bar
		395 [500]	468048	156,06	
		495 [600]	468058	156,06	
		795 [900]	468078	186,16	
Towel hook Set of 2 high-quality towel hooks in steel, chrome-plated, with soft insert for simple attachment; max. load 5 kg			480438	57,04	Metropolitan Spa / Bar, Kazeane
Towel rail High-quality design in brass, chrome-plated, with 2-point magnetic holder; max. load 5 kg		399 (297)	471108	269,02	Roda Twist Spa Air, Metropolitan Spa / Bar
		432 (330)	471118	280,57	
		531 (429)	471128	308,62	
Towel hook High-quality double hook in brass, chrome-plated, with 1-point magnetic holder; max. load 5 kg		100	470328	135,31	Roda Twist Spa Air, Metropolitan Spa / Bar
Lambswool cleaning brush 3-finger brush with real lambswool trimming for optimum cleaning of the tubes, and all points that are hard to access			601040	60,41	Yucca ²⁾ , Toga
			601020	53,81	Charleston Bar

¹⁾ Overall length of the holder at the outermost points; figure in round brackets for fixing dimension for 2-point attachment; figure in square brackets for related radiator length.

²⁾ Yucca, Yucca Asym.

Electric heating elements for dual energy operation

Electric heating element WIVAR II ¹⁾

Standard version for temperature control directly at electric heating element (as towel warmer ) or via optional control device model 1 (as electric radiator ). With control knob to set the medium temperature and LED indicator for the operating mode (see below); white plastic box, Ø 34 mm; 134 mm in length.

Nominal output 300, 600, 900 or 1200 watts. Supply voltage 230–240 V, protection class I (with earth wire), VDE-tested, IP64 degree of protection (splash-proof). With conical ½" screw-in thread incl. assembly key. 3-core connection cable, 1,20 m, downwards outlet with white plug.

Operating modes

- Frost protection ~12°C (LED flashes blue every 10 s)
- Heating level 1 ~50°C (green LED)
- Heating level 2 ~65°C (orange LED)
- Timer ~65°C for 2 h (LED flashes orange every 2 s)

Suitable for Zehnder decorative radiators:

Yucca, Yucca Asym, Subway, Toga, Forma Spa
(for allocation of output to the radiator models, see product pages)



Model	Nominal output Watt	Length max. mm	Article number	Price €
WIVAR 300	300	305	862522	420,16
WIVAR 600	600	475	862532	439,61
WIVAR 900	900	645	862542	476,99
WIVAR 1200	1200	830	862552	509,89

Electric heating element WIVAR Hotel

Version same as WIVAR II, but specifically for connection to a switchable socket. Heating level 1 is selected automatically when the system is connected to the mains power supply.



Model	Nominal output Watt	Length max. mm	Article number	Price €
WIVAR Hotel 300	300	305	862400	420,16
WIVAR Hotel 600	600	475	862430	439,61
WIVAR Hotel 900	900	645	862460	476,99
WIVAR Hotel 1200	1200	830	862490	509,89

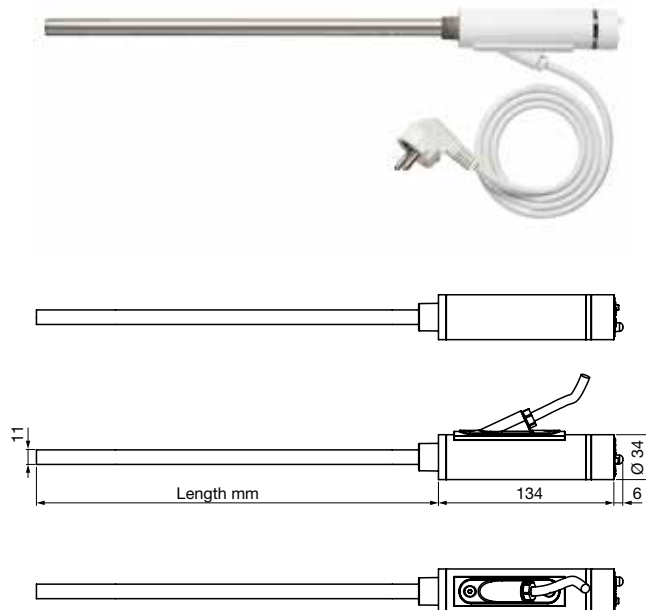

Cover parts for electric heating element WIVAR II / WIVAR Hotel

For adapting the electric heating element to the radiator colour

Version	Article number	Price €
Cover parts set, chrome-plated	889308	112,17
Cover parts set, in special colour	889309	89,71



Control device model 1

Battery-operated remote control device (white plastic housing) for room temperature control and for controlling timer functions for WIVAR II; dimensions 88 x 88 x 21 mm.



Model	Article number	Price €
Control device model 1, white	895351	216,83

Functions

- Frost protection ~12°C
- Room temperature control with 4 adjustable temperatures
- Timer ~65°C with selectable times: 1/2/4 h
- Battery status indicator
- Option to load a weekly programme using Bluetooth and the Android and iOS app



¹⁾ Can be used in hot water heating systems with max. operating temperature of 85°C

For legend, see "Electric operation and Ecodesign Directive" on page 173  

Electric heating elements for dual energy operation

Electric heating element DBM 2)

Degree of protection IP44 (splash-proof), for supply voltage 230 V \pm 10%. With G 1/2" screw-in thread and 3-core connection cable (1,2 m) with safety plug, collar and assembly key. With dry-running protection against operation without sufficient filling quantity. With rotary knob for selecting the following operating modes:

- Medium temperature max. 40°C
- Medium temperature max. 70°C
- Timer with automatic shut-off after 2 hours
- Off



Model	Nominal output Watt	Max. length in mm	Article number	Price €
DBM 300 white	300	330	857461	405,96
DBM 300 chrome	300	330	857468	476,81
DBM 600 white	600	480	857481	433,24
DBM 600 chrome	600	480	857488	504,06
DBM 900 white	900	630	857501	514,97
DBM 900 chrome	900	630	857508	542,22
DBM 1200 white	1200	800	857521	542,22

Suitable for decorative radiators: Kazeane, Toga, Forma Spa (for allocation of output to the radiator models, see product pages)

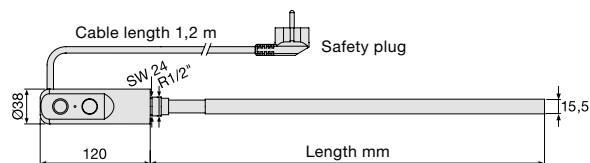

Electric heating element RICA 2)

Degree of protection IP54 (splash-proof), for mains voltage of 230 V \pm 10%. With G 1/2" screw-in thread and 3-core connection cable (1,2 m) with safety plug. With integrated temperature controller, with fixed nominal value of 70°C and safety temperature limiter, without dry-running protection. (The electric heating element must be replaced after activation of the temperature limiter. Cannot be repaired!)



Model	Nominal output Watt	Max. length in mm	Article number	Price €
RICA 300	300	450	893100	208,51
RICA 600	600	700	893200	220,31
RICA 900	900	900	893300	228,62
RICA 1200	1200	1200	893400	240,52

Suitable for decorative radiators: Toga (for allocation of output to the radiator models, see product pages)



For legend, see "Electric operation and Ecodesign Directive" on page 173 

Electric heating elements for dual energy operation

Electric heating element IHE ²⁾

Degree of protection IP65 (protected from low pressure water jets from any direction), protection class I, for main voltage 230 Volt ± 10 %. With G 1/2" screw-in thread and 3-core connection cable (1,2 m) with safety plug. With built-in temperature control, patented by Zehnder, for energy saving operation and increased life-span compared to conventional heating elements. The patented temperature control causes the heating element to quickly heat-up and when reaching its temperature limit to reduce its power consumption to 50 %, resulting in reduced switching cycles and avoiding over-heating. This reduces the power consumption in continuous operation, ensures a safe operation and through reduced switching cycles increases the life-span of the heating element. Temperature limit of heat transfer fluid approx. 70 °C. With dry-running protection (after response of the temperature limiter and repair of the cause e. g. low fluid level, the heat element can be further used after a reset). Housing and cable / plug in white. The immersion heater IHE can be used in dual energy operation without control or in combination with on-site regulation.

Model	Nominal output Watt	Max. length ³⁾ in mm	Article number	Price €
IHE White	300	400	858151	83,97
IHE White	600	620	858161	88,67
IHE White	900	850	858171	97,91

Suitable for Zehnder decorative radiators: Yucca, Metropolitan, Kazeane, Quaro, Subway, Toga, Forma

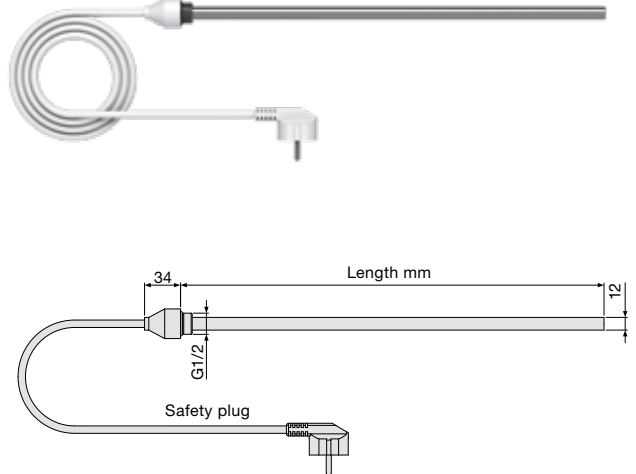

T-piece

For dual energy operation of hot water central heating system with electric heating element. Installation of the T-piece in the return for vertical installation of the electric heating elements WIVAR II / WIVAR Hotel, RICA or DBM¹⁾ and connection of the return via an angled return screw connection.

Model	Article number	Price €
T-piece white (WIVAR, RICA, IHE)	853181	27,19
T-piece chrome (WIVAR, RICA, IHE)	853188	28,34
T-piece white (DBM, IHE)	853111	27,19
T-piece chrome (DBM, IHE)	853118	28,34













1) T-piece for DBM incl. O-ring and collar

2) Can be used in hot water heating systems with max. operating temperature of 95°C and maximum operating pressure of 4,0 bar



3) Manifold, in which the heat element is build-in needs to have 1,5 times the length of the heating element

Thermostats

Description		Version	Article number	Price €	Application
Zehnder thermostat "Design Line" Thermostat with integrated fluid sensor. Can be restricted and locked to individual reference value of 6,5 - 28 °C, connection for thermostat M 30 x 1,5		White Chrome Stainless steel optic Copper Bronze ¹⁾ Special finish	841271 841278 853720 853850 853860 841279	64,11 64,11 131,65 171,72 171,72 73,79	For all radiators with threaded connection M 30 x 1,5 mm
Zehnder thermostat "LH2" Thermostat with integrated fluid sensor, tested according to EN 215. Can be limited and blocked to individual nominal value. Reference range value 7 to 28 °C. Version with zero setting, thermostat threaded connection M 30 x 1,5		White Chrome	819140 819148	35,02 60,35	
Zehnder thermostat "DH" Thermostat with integrated expansion material sensor, reference value range 7 to 28 °C. Version with zero setting. Threaded connection M 30 x 1,5 with cover of union nut		White Chrome	819050 819058	35,02 53,36	
Zehnder thermostat "SH" Elegant thermostat with integrated fluid sensor, tested according to EN 215, reference value range 7 to 28 °C. Version with zero setting. Thermostat threaded connection M 30 x 1,5 with chrome-plated union nut		White Chrome Stainless steel	819080 819088 819082	38,09 53,47 53,47	
Angle adapter for thermostat M 30 x 1,5		White	819500	13,92	
Directional air vent, nickel-plated, self-sealing		¼" ½"	816010 816030	4,17 4,17	
Decorative directional air vent set, chrome Comprising 2 x directional air vents (½") with cover, vent tool and plug key		Chrome	816508	13,98	
Directional air vent, chrome-plated, self-sealing Suitable for max. operating pressure of 18 bar		½"	816070	7,09	
Blanking plug, nickel-plated, self-sealing		½"	974020	2,39	
Blanking plug, chrome-plated Suitable for max. operating pressure of 18 bar		½"	974058	6,28	

¹⁾ Suitable for connection fitting and valve body in brass.

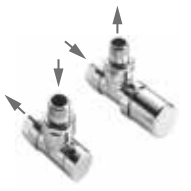
Zehnder Design Line Valves

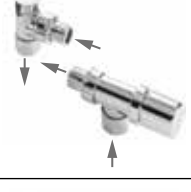
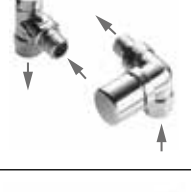
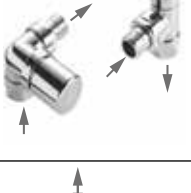
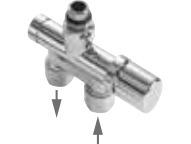





Description		Version	Article nr.	Price €	Application
Valve set type A Angled flow and lockshield, themostatic insert M 30 x 1,5 mm with pre-setting 1-7, manual handwheel, including 2 pcs 3/4" Eurocone nuts Ø 16,8 mm in finish of valve body, without adaptors for pipes		White Chrome	838881 838888	76,44 76,44	For all radiators with threaded connection M 30 x 1,5 mm
Valve set type B Angled flow and lockshield, manual handwheel themostatic insert M 30 x 1,5 mm with pre-setting 1-7, including 2 pcs 3/4" Eurocone nuts Ø 16,8 mm in finish of valve body, without adaptors for pipes		White Chrome Stainless steel optic Copper Brass	838891 838898 838930 838900 838910	119,66 119,66 137,38 194,62 194,62	
Valve set type C Straight flow and lockshield, manual handwheel themostatic insert M 30 x 1,5 mm with pre-setting 1-7, including 2 pcs 3/4" Eurocone nuts Ø 16,8 mm in finish of valve body, without adaptors for pipes		White Chrome	838941 838948	119,66 119,66	
Valve set type D Reverse flow and angled lockshield, manual handwheel themostatic insert M 30 x 1,5 mm with pre-setting 1-7, including 2 pcs 3/4" Eurocone nuts Ø 16,8 mm in finish of valve body, without adaptors for pipes		White Chrome	838951 838958	125,37 125,37	
Valve set type G Angled-angled flow head to the left, themostatic insert M 30 x 1,5 mm with pre-setting 1-7, manual handwheel, lockshield angled, including 2 pcs 3/4" Eurocone nuts Ø 16,8 mm in finish of valve body, without adaptors for pipes		White Chrome Stainless steel optic	838981 838988 838980	133,41 133,41 159,85	
Valve set type I Angled-angled flow head to the right, manual handwheel, themostatic insert M 30 x 1,5 mm with pre-setting 1-7, lockshield angled, including 2 pcs 3/4" Eurocone nuts Ø 16,8 mm in finish of valve body, without adaptors for pipes		White Chrome Stainless steel optic	838991 838998 838990	133,41 133,41 159,85	
Valve set type J Single entry/monotube valve vertical, straight, with by-pass, themostatic insert M 30 x 1,5 mm with pre-setting 1-7, turnable for manual handwheel to the left or right, including 2 pcs 3/4" Eurocone nuts Ø 16,8 mm in finish of valve body and dip tube, without adaptors for pipes		White Chrome	839001 839008	132,50 132,50	

→ Direction of flow

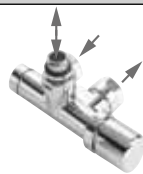
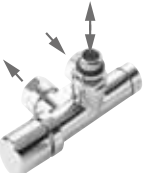
All valves etc. suitable for operating temperature max. 110 °C and operating pressure max. 10 bar, if not indicated differently.
For further information, please see information in the keyword list.



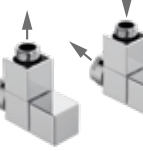

All valves respectively connection fittings are delivered with handwheels as protection caps (thermostatic heads to be ordered separately) and union nuts as transition to the tube (matching adaptors and connection sets are to be ordered separately!) → see page 168.

Zehnder Design Line Valves

Description		Version	Article nr.	Price €	Application
Valve type K Single entry/monotube valve vertical, angled, with by-pass, thermostatic insert M 30 x 1,5 mm with pre-setting 1-7, manual handwheel to the right, including 2 pcs 3/4" Eurocone nuts Ø 16,8 mm in finish of valve body and dip tube, without adaptors for pipes		White Chrome Stainless steel optic	839011 839018 839010	129,26 129,26 197,37	For all radiators with 1/2" female thread
Valve type M Single entry/monotube valve vertical, angled, with by-pass, thermostatic insert M 30 x 1,5 mm with pre-setting 1-7, manual handwheel to the left, including 2 pcs 3/4" Eurocone nuts Ø 16,8 mm in finish of valve body and dip tube, without adaptors for pipes		White Chrome	839021 839028	129,26 129,26	
Valve type N Single entry/monotube valve horizontal, straight, with by-pass, thermostatic insert M 30 x 1,5 mm with pre-setting 1-7, manual handwheel to the top, including 2 pcs 3/4" Eurocone nuts Ø 16,8 mm in finish of valve body and dip tube, without adaptors for pipes		White Chrome	839031 839038	173,82 173,82	
Valve type O 50 mm straight, thermostatic insert M 30 x 1,5 mm with pre-setting 1-7 and by-pass, turnable for manual handwheel to the left or right, including 2 pcs 3/4" Eurocone nuts Ø 16,8 mm in finish of valve body, without adaptors for pipes		White Chrome	839041 839048	132,50 132,50	
Valve type P 50 mm angled, with by-pass, to the right thermostatic insert M 30 x 1,5 mm, with pre-setting 1-7 and by-pass, manual handwheel, including 2 pcs 3/4" Eurocone nuts Ø 16,8 mm in finish of valve body, without adaptors for pipes		White Chrome Stainless Steel optic Copper Brass	839051 839058 839090 839060 839070	132,50 132,50 171,72 228,96 228,96	
Valve type Q 50 mm angled, with by-pass, to the left thermostatic insert M 30 x 1,5 mm with pre-setting 1-7 and by-pass, manual handwheel, including 2 pcs 3/4" Eurocone nuts Ø 16,8 mm in finish of valve body, without adaptors for pipes		White Chrome Stainless Steel optic Copper Brass	839101 839108 839140 839110 839120	132,50 132,50 171,72 228,96 228,96	
Valve type U 50 mm swiveling design valve straight or angled, with by-pass, thermostatic insert M 30 x 1,5 mm with pre-setting 1-7, manual handwheel to the left or to the right, including 2 pcs 3/4" Eurocone nuts Ø 16,8 mm in finish of valve body, without adaptors for pipes		White Chrome	839171 839178	242,19 242,19	
Valve type W Square shaped, angled, lockshield, not thermostatic, manual handwheel, including 2 pcs 3/4" Eurocone nuts Ø 16,8 mm in finish of valve body, without adaptors for pipes		Chrome	839198	220,83	

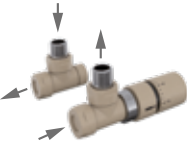
All valves respectively connection fittings are delivered with handwheels as protection caps (thermostatic heads to be ordered separately) and union nuts as transition to the tube (matching adaptors and connection sets are to be ordered separately!) see page 168.











Zehnder Design Line Coloured Valves

Description		Version	Article nr.	Price €	Application
Zehnder thermostat "Design Line" Thermostat with integrated fluid sensor. Can be restricted and locked to individual reference value of 6,5 - 28 °C, connection for thermostat M 30 x 1,5		Special finish	841279	64,11	For all radiators with ½" female thread, in colour of radiator
Valve set type B Angled flow and lockshield, thermostatic insert M 30 x 1,5 mm with pre-setting 1-7, including 2 pcs 3/4" Eurocone nuts Ø 16,8 mm in finish of valve body, without adaptors for pipes. Thermostat Design Line with integrated fluid sensor. Can be restricted and locked to individual reference value of 6,5 - 28 °C, connection for thermostat M 30 x 1,5.		Special finish			
		Valve set with manual handwheel	838899	119,66	
		Valve set including Design Line thermostat	839439	193,45	
Valve type O 50 mm straight, thermostatic insert M 30 x 1,5 mm with pre-setting 1-7 and by-pass, turnable to the left or right, including 2 pcs 3/4" Eurocone nuts Ø 16,8 mm in finish of valve body, without adaptors for pipes. Thermostat Design Line with integrated fluid sensor. Can be restricted and locked to individual reference value of 6,5 - 28 °C, connection for thermostat M 30 x 1,5.		Special finish			
		Valve set with manual handwheel	839049	132,50	
		Valve set including Design Line thermostat	839409	206,29	
Valve type P 50 mm angled, with by-pass, to the right thermostatic insert M 30 x 1,5 mm, with pre-setting 1-7 and by-pass, including 2 pcs 3/4" Eurocone nuts Ø 16,8 mm in finish of valve body, without adaptors for pipes. Thermostat Design Line with integrated fluid sensor. Can be restricted and locked to individual reference value of 6,5 - 28 °C, connection for thermostat M 30 x 1,5.		Special finish			
		Valve set with manual handwheel	839059	132,50	
		Valve set including Design Line thermostat	839419	206,29	
Valve type Q 50 mm angled, with by-pass, to the left thermostatic insert M 30 x 1,5 mm with pre-setting 1-7 and by-pass, including 2 pcs 3/4" Eurocone nuts Ø 16,8 mm in finish of valve body, without adaptors for pipes. Thermostat Design Line with integrated fluid sensor. Can be restricted and locked to individual reference value of 6,5 - 28 °C, connection for thermostat M 30 x 1,5.		Special finish			
		Valve set with manual handwheel	839109	132,50	
		Valve set including Design Line thermostat	839429	206,29	





→ Direction of flow

All valves etc. suitable for operating temperature max. 110 °C and operating pressure max. 10 bar, if not indicated differently. For further information, please see information in the keyword list.

Zehnder Design Line Accessories

Description		Version	Article nr.	Price €	Application
Nut ½", 2 pcs ½" female thread on to ¾" Eurocone		White	842001	24,23	As an adaptor for connection fittings with ½" external thread
		Chrome	842008	24,23	
Adaptors, 2 pcs Multilayer Ø 14 mm		Brass	842160	11,41	Matching to Zehnder Design Line valves and union nuts 2 x ¾" Eurocone (in scope of delivery)
Adaptors, 2 pcs Multilayer 16 x 2,0 mm		Brass	842060	11,41	
Adaptors, 2 pcs PEX 12 x 1,0 mm		Brass	842070	11,41	
Adaptors, 2 pcs Multilayer Ø 16 x 2,25 mm		Brass	842170	11,41	
Adaptors, 2 pcs Copper Ø 10 mm Copper Ø 12 mm Copper Ø 14 mm Copper Ø 15 mm Copper Ø 16 mm		Brass Brass Brass Brass Brass	842080 842090 842100 842110 842120	7,13 7,13 7,13 7,13 7,13	
Nuts Ø 18 mm - ¾" Eurocone + adaptors copper Ø 18 mm 2 pcs		Chrome / brass	842140	35,63	
Nuts Ø 20,8 mm - ¾" Eurocone + adaptors multilayer Ø 20 x 2 mm 2 pcs		Chrome / brass	842150	35,63	
Universal Adaptor set (without nuts ¾" Eurocone - Ø 16,8 mm) - 2 pcs Alu/Pex multilayer 16 x 2,0 mm - 2 pcs PEX 12 x 1 mm - 2 pcs CU 12 mm - 2 pcs CU 14 mm - 2 pcs CU 15 mm		Brass	842180	39,90	
Sleeving kit L = 70 mm L = 160 mm		Chrome	853738	24,23	For connecting radiators
		Chrome	853668	31,33	
Collar Ø 45 mm - for Ø ½" - for Ø 10 mm - for Ø 12 mm - for Ø 14 mm - for Ø 15 mm - for Ø 16 mm - for Ø 18 mm		White	816241	2,85	For existing connections
		Chrome	816248	7,13	
		White	816251	2,85	
		Chrome	816258	7,13	
		White	816261	2,85	
		Chrome	816268	7,13	
		White	816271	2,85	
		Chrome	816278	7,13	
		White	816281	2,85	
		Chrome	816288	7,13	
		White	816291	2,85	
		Chrome	816298	7,13	
White	816301	2,85			
Chrome	816308	7,13			

Connection fittings

Description		Version	Article number	Price €	Application
<p>Fitting for Zehnder Yucca For single- and twin-tube systems (connection size 50 mm); valve on right, presettable valve insert AV9, flow on both sides, for thermostat M 30 x 1,5; connections at back 3/4" external thread, flow/return lockable, with 1/2" connection for electric heating element on left (can be retrofitted when removing the fittings); connection fitting set to twin-tube operation, can be used for single-tube operation by opening the by-pass screw; supplied as standard with matching cover and cover parts set for the heating element in colour of the radiator (for RAL 9016 without cover parts set), fixings for the cover included with fitting, thermostat available for surcharge; maximum operating pressure 10 bar, 110 °C; version of connection fitting for dual energy operation with WIVAR II / WIVAR Hotel (long cover)</p>	 	Standard finish Special finish Chrome-plated	976031 976039 976038	172,59 233,28 289,54	
Version of connection fitting for operation on central heating system (short cover)	 	Standard finish Special finish Chrome-plated	976021 976029 976028	172,59 184,97 229,18	
Version of connection fitting without cover		Nickel-plated	976103	130,49	

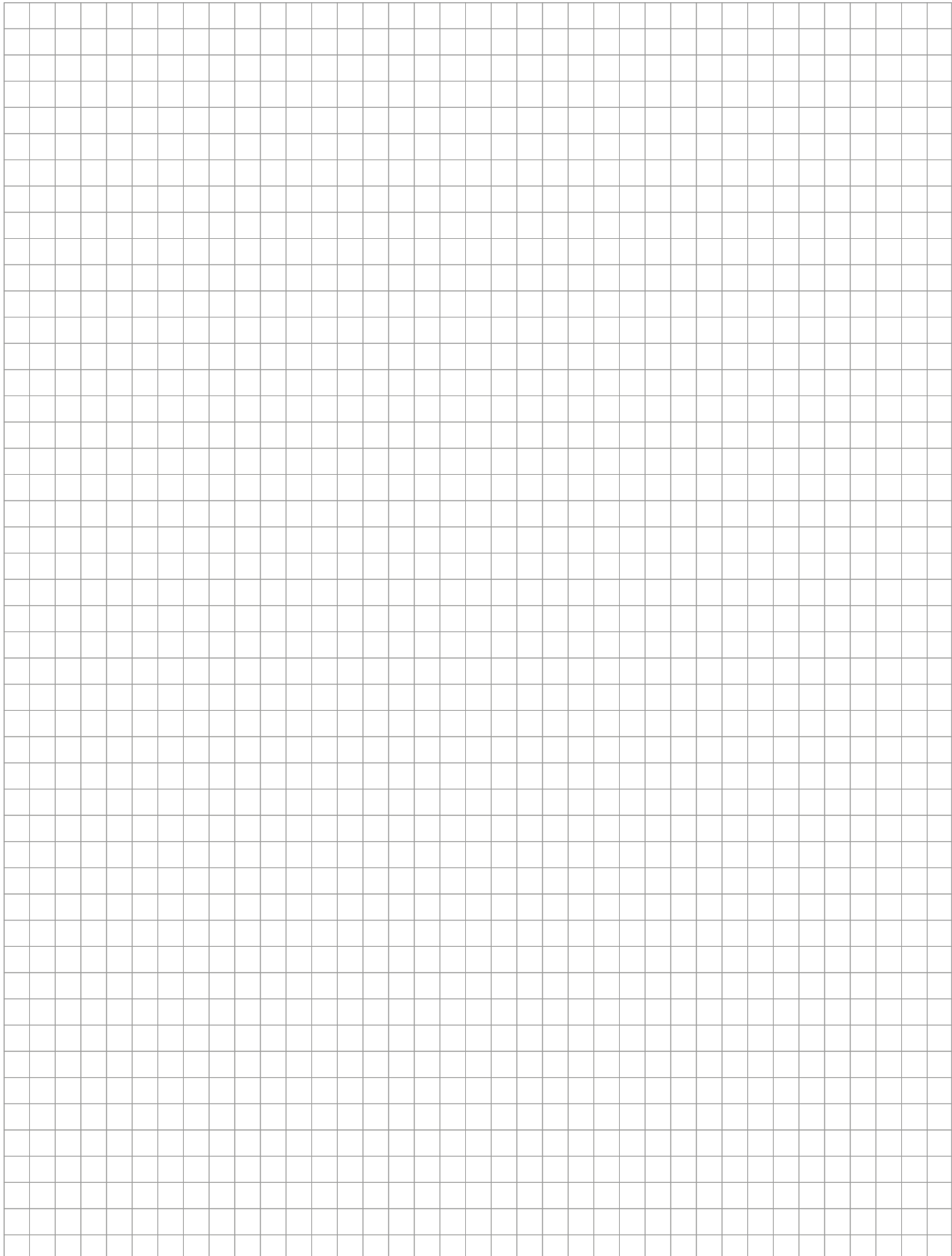
A large, empty grid of small squares occupies the central portion of the page, intended for taking notes. The grid is composed of approximately 30 columns and 50 rows of squares.

Conversion table, f_1 factors

	t_2	t_1	t_r	n	70			65			60			55			50			45		
					1,25	1,30	1,35	1,25	1,30	1,35	1,25	1,30	1,35	1,25	1,30	1,35	1,25	1,30	1,35	1,25	1,30	1,35
90	10	1,516	1,542	1,568	1,499	1,462	1,483	1,363	1,380	1,397	1,283	1,296	1,309	1,201	1,210	1,219	1,117	1,122	1,127			
	15	1,380	1,398	1,416	1,311	1,319	1,333	1,228	1,238	1,248	1,149	1,155	1,162	1,067	1,070	1,073	0,982	0,981	0,981			
	18	1,300	1,313	1,327	1,229	1,235	1,245	1,148	1,155	1,161	1,069	1,072	1,075	0,987	0,987	0,986	0,902	0,898	0,894			
	20	1,247	1,258	1,269	1,175	1,180	1,187	1,096	1,100	1,104	1,017	1,017	1,018	0,935	0,932	0,930	0,849	0,843	0,838			
	22	1,194	1,202	1,211	1,122	1,125	1,130	1,043	1,045	1,047	0,964	0,963	0,962	0,882	0,878	0,874	0,796	0,789	0,781			
	24	1,142	1,148	1,154	1,069	1,071	1,073	0,992	0,991	0,991	0,913	0,909	0,906	0,830	0,824	0,818	0,743	0,734	0,726			
85	10	1,454	1,476	1,498	1,387	1,398	1,416	1,305	1,319	1,333	1,228	1,238	1,248	1,149	1,155	1,162	1,067	1,070	1,073			
	15	1,319	1,334	1,349	1,251	1,258	1,269	1,172	1,180	1,187	1,096	1,100	1,104	1,017	1,017	1,018	0,935	0,932	0,930			
	18	1,240	1,251	1,261	1,171	1,175	1,182	1,094	1,098	1,102	1,017	1,018	1,019	0,939	0,936	0,934	0,856	0,851	0,846			
	20	1,187	1,196	1,204	1,118	1,121	1,125	1,042	1,044	1,045	0,966	0,964	0,963	0,887	0,883	0,878	0,804	0,797	0,790			
	22	1,135	1,141	1,147	1,065	1,067	1,069	0,991	0,990	0,990	0,915	0,911	0,908	0,836	0,830	0,824	0,753	0,744	0,736			
	24	1,084	1,087	1,091	1,013	1,013	1,014	0,941	0,937	0,935	0,864	0,859	0,854	0,785	0,777	0,770	0,701	0,691	0,682			
80	10	1,391	1,409	1,428	1,325	1,334	1,349	1,247	1,258	1,269	1,172	1,180	1,187	1,096	1,100	1,104	1,017	1,017	1,018			
	15	1,258	1,269	1,281	1,191	1,196	1,204	1,116	1,121	1,125	1,042	1,044	1,045	0,966	0,964	0,962	0,889	0,885	0,881			
	18	1,179	1,187	1,195	1,111	1,114	1,119	1,038	1,040	1,041	0,965	0,964	0,962	0,889	0,885	0,881	0,810	0,803	0,797			
	20	1,127	1,133	1,138	1,059	1,061	1,063	0,987	0,987	0,986	0,914	0,911	0,908	0,839	0,833	0,827	0,759	0,751	0,743			
	22	1,076	1,097	1,082	1,008	1,008	1,008	0,937	0,934	0,932	0,864	0,859	0,854	0,788	0,781	0,773	0,709	0,699	0,690			
	24	1,025	1,026	1,027	0,956	0,955	0,954	0,887	0,883	0,878	0,814	0,808	0,801	0,739	0,730	0,721	0,659	0,648	0,637			
75	10	1,326	1,342	1,357	1,262	1,269	1,281	1,187	1,196	1,204	1,116	1,121	1,125	1,042	1,044	1,045	0,966	0,964	0,963			
	15	1,195	1,204	1,212	1,130	1,130	1,138	1,058	1,061	1,036	0,987	0,987	0,986	0,914	0,911	0,908	0,839	0,833	0,827			
	18	1,118	1,122	1,127	1,051	1,053	1,055	0,982	0,981	0,981	0,912	0,908	0,905	0,839	0,833	0,827	0,763	0,755	0,747			
	20	1,066	1,069	1,072	1,000	1,000	1,000	0,932	0,929	0,927	0,862	0,857	0,852	0,789	0,782	0,775	0,714	0,704	0,695			
	22	1,016	1,016	1,017	0,949	0,948	0,946	0,882	0,878	0,874	0,813	0,806	0,799	0,740	0,732	0,723	0,665	0,654	0,643			
	24	0,966	0,964	0,963	0,899	0,897	0,893	0,833	0,827	0,821	0,764	0,756	0,748	0,692	0,682	0,672	0,616	0,604	0,592			
70	10				1,198	1,204	1,212	1,127	1,133	1,138	1,058	1,061	1,063	0,987	0,987	0,986	0,914	0,911	0,908			
	15				1,068	1,069	1,072	1,000	1,000	1,000	0,932	0,929	0,927	0,862	0,857	0,852	0,789	0,782	0,775			
	18				0,991	0,990	0,990	0,925	0,922	0,919	0,858	0,853	0,847	0,788	0,781	0,773	0,716	0,707	0,697			
	20				0,940	0,939	0,936	0,876	0,871	0,867	0,809	0,802	0,795	0,740	0,731	0,722	0,668	0,657	0,646			
	22				0,890	0,887	0,883	0,827	0,821	0,815	0,761	0,752	0,744	0,692	0,682	0,672	0,620	0,608	0,596			
	24				0,840	0,837	0,831	0,779	0,771	0,763	0,713	0,703	0,694	0,644	0,633	0,622	0,572	0,560	0,547			
65	10							1,066	1,069	1,072	1,000	1,000	1,000	0,932	0,929	0,927	0,862	0,857	0,852			
	15							0,941	0,936	0,936	0,876	0,871	0,867	0,809	0,802	0,795	0,740	0,731	0,722			
	18							0,867	0,862	0,857	0,803	0,796	0,789	0,737	0,728	0,719	0,668	0,657	0,647			
	20							0,818	0,812	0,805	0,755	0,746	0,738	0,689	0,679	0,669	0,621	0,609	0,597			
	22							0,770	0,762	0,755	0,707	0,698	0,688	0,642	0,631	0,620	0,574	0,561	0,549			
	24							0,723	0,714	0,705	0,661	0,650	0,639	0,596	0,584	0,572	0,528	0,515	0,502			
60	10										0,941	0,939	0,936	0,876	0,871	0,867	0,809	0,802	0,795			
	15										0,818	0,812	0,805	0,755	0,746	0,738	0,689	0,679	0,669			
	18										0,747	0,738	0,729	0,684	0,674	0,664	0,619	0,607	0,596			
	20										0,700	0,690	0,680	0,638	0,626	0,615	0,573	0,560	0,548			
	22										0,653	0,642	0,631	0,592	0,579	0,567	0,528	0,514	0,501			
	24										0,607	0,595	0,584	0,546	0,533	0,521	0,483	0,469	0,455			
55	10															0,818	0,812	0,805	0,755	0,746	0,738	
	15															0,700	0,690	0,680	0,638	0,626	0,615	
	18															0,630	0,619	0,607	0,569	0,556	0,544	
	20															0,585	0,572	0,560	0,524	0,511	0,498	
	22															0,540	0,527	0,514	0,480	0,466	0,453	
	24															0,496	0,482	0,469	0,437	0,422	0,409	

Conversion factors f_1 for converting the standard thermal output at 75/65/20°C to other system temperatures: $\Phi = \Phi_s \cdot f_1$

The radiator exponent depends on the model and type of radiator and can therefore be found in the table containing the technical specifications for the respective radiator. For exponents other than those given, the correction factor can be interpolated or precisely calculated according to the above formulae. An exponent of 1,3 can be used for the approximate calculation.

$$\Phi = \Phi_s \times f_1 \text{ or } \Phi = \Phi_s \times \left(\frac{\Delta t}{\Delta t_n} \right)^n$$

Example for Zehnder Yucca:

What is the effective output at 60/45/24°C?

$$\text{with } \Delta t = \frac{(t_1 - t_r) - (t_2 - t_r)}{\ln \left(\frac{t_1 - t_r}{t_2 - t_r} \right)} = \frac{t_1 - t_2}{\ln \left(\frac{t_1 - t_r}{t_2 - t_r} \right)}$$

Model YSD-130-080; $\Phi_s = 1024 \text{ W}$, exponent $n = 1,30$
 $t_1 = 60^\circ\text{C}$, $t_2 = 45^\circ\text{C}$, $t_r = 24^\circ\text{C}$

f_1 from table: $f_1 = 0,469$
 $\Phi_s = \Phi_s \times f_1 = 1024 \text{ W} \times 0,469 = 480 \text{ W}$

Keyword list

Accessories

A wide range of accessories are available for various additional uses, such as hanging up towels. For more information, see the section on "Accessories".

Baffle

To avoid reduced output, e.g. with a riding connection, internal installations, e.g. baffles, deflector plates, guide plates, are required. Detailed information is available on request.

Benefits

See "Product description"

CE marking

The CE marking on Zehnder radiators shows that they are manufactured in accordance with the prevailing European standard EN 442 and that the product has been subjected to the prescribed conformity evaluation procedure.



The following parameters, which allow the CE marking to be shown, can be found in the respective product section:

- Model description
- Max. operating pressure
- Nominal heat output

Product/product family	CE - Year
Zehnder Alban	CE - 20
Zehnder Archibald	CE - 16
Zehnder Deseo Verso	CE - 20
Zehnder Arteplano	CE - 17
Zehnder Chime	CE - 20
Zehnder Folio Belt	CE - 16
Zehnder Folio Hybrid	CE - 17
Zehnder Fain	CE - 21
Zehnder Yucca	CE - 05
Zehnder Vitalo	CE - 13
Zehnder Charleston	CE - 05
Zehnder Zenia	CE - 17
Zehnder Metropolitan	CE - 09
Zehnder Kazeane	CE - 17
Zehnder Roda	CE - 08
Zehnder Quaro	CE - 11
Zehnder Subway	CE - 08
Zehnder Toga	CE - 05
Zehnder Forma	CE - 05
Zehnder Klaro	CE - 16
Zehnder Stalox	CE - 06
Zehnder Bluebell	CE - 19
Zehnder Aura	CE - 13
Zehnder Fina Lean Bar	CE - 20
Zehnder Virando	CE - 16
Zehnder Impa	CE - 14
Zehnder Zeta	CE - 14

Cleaning

With a lambswool cleaning brush or soft cloth. Detailed information is available on request.

Conversion

Factor for converting the standard thermal output to thermal outputs at other system temperatures; see conversion table of f_1 factors

Corrosion protection

See "Finish" and "Surface protection"

Degree of protection

The degree of protection specifies the extent of protection that electrical equipment housing provides against dangerous parts getting into the equipment. The first number indicates the protection against the ingress of foreign objects, and the second the ingress of water.

Example: IP44

1. number = 4 = protection against solid foreign objects, 1,0 mm diameter or larger
2. number = 4 = protection against splash water

Dimensions

The dimensions indicated in the documentation are correct at the time of printing. Subject to change without notice.

Electric heating elements

Maximum temperature:

The maximum achievable temperature of the bathroom radiator depends on the following parameters: Nominal thermal output of the radiator, nominal output of the electric heating element, surrounding temperature, time switched on.

Output:

Only a limited electrical output can be installed in the bathroom radiators for safety reasons. Generally, the nominal output of the electric heating element of all Zehnder bathroom radiators should not be greater than the nominal output of the bathroom radiator (Φ_L at ΔT 50 K according to EN 442).

Mounting:

The electric heating element must be sealed with hemp or Teflon tape so that the mains cable is at the back facing the wall.

Please note:

- The electrical installation must comply with local regulations.
- In stationary installation (without plug), a switch must be installed (all-phase isolation from the mains with min. 3 mm contact spacing).
- The bathroom radiator with integrated electric heating element in central heating systems must always be completely filled with water and vented, observing the maximum permissible operating temperature of the applicable electric heating element in hot water heating systems.
- The expansion of the water in the system into the expansion vessel must be guaranteed at all times (do not block return).
- For electric-only bathroom radiators, the defined filling quantity must not be changed.
- The electric heating element must only be opened and the mains cable only replaced by the manufacturer.
- The electric heating element must only be installed vertically (housing always beneath the electric heating element).
- When using radiators with electric heating elements, the qualified electrician is the competent partner for the protective measures to be taken.
- Follow the operating instructions.

Position of electrical connection:

In bathrooms and other wet rooms, special conditions apply to the installation of switches and sockets according to DIN 57100/VDE0100. The suggested position of the socket is chosen so as to facilitate an easy connection. This suggestion does not release the electrical engineer from executing the electrical connection in accordance with local regulations.

Minimum clearances:



The minimum wall and floor clearances must be complied with (see relevant radiator chapter).

The minimum floor clearance must meet the user requirements. The clearance must be increased accordingly in public buildings and to allow the use of cleaning machines.













Keyword list

Electric operation and Ecodesign Directive

In deviation from dual energy operation in a central heating system, all electric radiators are fixed units that comprise the actual radiator body, a filling medium (heat transfer fluid), a heating element and associated controls. This unit is subject to a special function test and must not be changed. The heat transfer fluid is frost-proof up to -20°C as long as there are no other restrictions associated with the standard scope of delivery for the radiator in question. The product portfolio also includes dry electric radiators. A large number of radiator models with different control and regulation options are available for a wide range of applications.

Electric radiators are subject to the Ecodesign Directive. The aim of this Directive is to reduce the environmental effects of products that consume energy, with the entire product life-cycle taken into account. A points system is used to evaluate the extent to which the Directive has been fulfilled. Various functions, such as standby power consumption ≤ 0,5 W, weekly programme and open window detection, help to fulfil the minimum legal requirements (that is, they help to achieve the minimum number of points). Devices that meet the minimum requirements and are thus compliant with the Ecodesign Directive are marked with this symbol in the price list: . Towel warmers are not subject to the Ecodesign Directive. They are not intended for room heating and are marked with this symbol: .

The following table provides an overview of the available products combined with different control and regulation devices:

Product/ product family	Control device	Control device in combina- tion with app	Operation on electric heating element	without control device
Zehnder Archibald				
Zehnder Deseo Verso				
Zehnder Folio Glass				
Zehnder Folio Hybrid				
Zehnder Zenia ¹⁾				
Zehnder Fain				
Zehnder Yucca				
Zehnder Vitalo				
Zehnder Roda Twist Spa Air				
Zehnder Metropolitan				
Zehnder Kazeane				
Zehnder Quaro				
Zehnder Subway				
Zehnder Toga				
Zehnder Forma				
Zehnder Klaro				
Zehnder Aura				
Zehnder Fina Lean Bar				
Zehnder Virando				



Electric radiator (standard)



Electric radiator (available as an option)



Towel warmer (standard)



Towel warmer (available as an option)

Environment

The certification of our environmental management system to DIN EN ISO 14001 by an independent institution obliges us to make continuous improvements to our environmental services through reducing or avoiding environmental burdens and waste, encouraging the utilisation and protection of resources as well as observing all environmental laws and regulations applicable to us.

Finish

Ready-painted radiators in this price list have a two-coat finish (to DIN 55900, Part 1 and 2, comprising primer and top coat). The top coat is a powder coating. The high-quality Zehnder powder coating produces an especially smooth and extremely durable surface. Further information on the applications and limits of radiators is contained in information sheet number 7 of the BDH (Bundesverband der Deutschen Heizungsindustrie e.V.). Please always use the original RAL, NCS colour samples or original colour charts of the sanitary manufacturers for exact colour matching.

For technical production reasons, minor colour deviations are possible in paints on steel surfaces, also when taking the prevailing lighting conditions into account. Deviations can also occur when comparing painted steel surfaces (radiators) with ceramic products. The colours shown here (see inside of back cover) are not binding for printing reasons. Radiators in metallic colours, e.g. RAL 9006, RAL 9007 and Anthracite are unique products and visual differences may appear in the colour, depending on the radiator.

Fixings

To ensure that radiators are fitted safely, the weight of the radiator and other aspects must be considered when choosing the right quality and quantity of brackets. Additional loads and foreseeable misuse of a radiator must be considered or ruled out by planning and implementation in line with the known building use. The installation situation and accessibility are just as important criteria as brickwork, bracket shape, location of the suspensions, locking device, add-on elements and the like. See also VDI 6036.

Flow connection

This concerns the connection on the radiator through which the hot water flows into the radiator.

Galvanisation

See "Surface protection"

Galvanisation

Galvanisation creates structures on the surface.

These are caused by the technological process and therefore are not a fault. We cannot guarantee a clean, smooth surface. Galvanised radiators are generally delivered with a top coat. For explanation, see "Surface protection".

Keyword list

Product/product family	Special version, galvanised
Zehnder Alban	-
Zehnder Archibald	-
Zehnder Arteplano	x
Zehnder Folio Belt	-
Zehnder Folio Hybrid	-
Zehnder Fain	-
Zehnder Yucca	x
Zehnder Vitalo	-
Zehnder Roda Twist Spa Air	-
Zehnder Charleston	x
Zehnder Metropolitan	x
Zehnder Kazeane	x
Zehnder Roda Spa Asym	-
Zehnder Quaro	x
Zehnder Subway	x
Zehnder Toga	x
Zehnder Forma	x
Zehnder Klaro	x
Zehnder Aura	-
Zehnder Bluebell	-
Zehnder Fina Lean Bar	-
Zehnder Virando	-
Zehnder Impa	-
Zehnder Zeta	-

Hydraulic balancing

By hydraulic balancing the various system resistances are set so that the radiators are supplied with the necessary quantity of water at all operational points, in order to achieve the desired thermal output.

Inlet and outlet resistance

The coefficient of resistance (zeta value) is used to calculate the pressure loss. For more information, see "Pressure loss".

Minimum water flow

If the flow of water through a radiator is heavily reduced, the heat output can fall far below the calculated or indicated value. For this reason, a minimum water flow should always be ensured. The following table shows the approximate minimum water flows $q_{m \text{ min}}$ in % of the nominal flow rate $q_{m \text{ s}}$ which does not cause the heat output to deviate from the standard characteristic curve by more than 5%.

Product/product family	$q_{m \text{ min}}$ in % of $q_{m \text{ s}}$
Zehnder Archibald	30%
Zehnder Yucca, Zehnder Metropolitan, Zehnder Kazeane, Zehnder Roda Spa Asym, Zehnder Quaro, Zehnder Toga, Zehnder Forma, Zehnder Klaro, Zehnder Stalox, Zehnder Aura, Zehnder Bluebell, Zehnder Impa, Zehnder Zeta	27%
Zehnder Arteplano, Zehnder Charleston, Zehnder Fina, Zehnder Folio / Folio Belt, Zehnder Vitalo	17 %
Zehnder Virando, Zehnder Impa, Zehnder Zeta	27%

Nominal heat output

The nominal heat output of a radiator is determined in an independent, certified test laboratory according to standard EN 442 at the standard operating temperatures of 75/65/20°C. The conversion of the thermal output to other system temperatures is done on the basis of the nominal heat output according to EN 12831. For easy dimensioning, additional outputs for frequently used temperatures are shown alongside the nominal heat output:

- 70/55/24 °C
- 55/45/24 °C
- 55/45/20 °C

The conversion of the nominal heat output to deviating system temperatures can be done using the f_1 -factors on the conversion factors page.

Operating pressure

The maximum permissible operating pressure of a radiator depends on its geometry, the material used and the finish. Max. permissible operating pressure according to product:

Product/product family	Standard version [bar]	High-pressure version [bar]
Zehnder Alban	5,2	-
Zehnder Archibald	12	-
Zehnder Arteplano	4,6	10
Zehnder Chime	5,2	-
Zehnder Folio Belt	10	-
Zehnder Folio Hybrid	10	10
Zehnder Fain	10	-
Zehnder Yucca	12	-
Zehnder Vitalo	10	-
Zehnder Vitalo Easy Fit	6	-
Zehnder Charleston	10	-
Zehnder Metropolitan	4	-
Zehnder Kazeane	4	-
Zehnder Roda Spa Asym	4	-
Zehnder Quaro	10	-
Zehnder Subway	10	18
Zehnder Toga	11,5	18
Zehnder Klaro	11,5	18
Zehnder Stalox	12	18
Zehnder Aura	10	-
Zehnder Bluebell	10	-
Zehnder Fina Lean Bar	6	-
Zehnder Virando	10	-
Zehnder Impa	13	-
Zehnder Zeta	10	-

Suitable fittings, plugs and air vents, etc. must be ensured in connection with high pressure applications in excess of 10 bar. Pressure loads up to max. 18 bar are only adaptable for suitable radiators and components as long as pressure shocks can be ruled out.

Operating temperature

Zehnder radiators can generally be used for hot water heating systems up to 110°C. Exceptions are noted on the product in question. They are suitable for use in district heating, low temperature and condensing systems.

Packaging

The packaging of Zehnder radiators serves as protection against damage during transport and on building sites. It must be removed before starting the system for the first time in order to avoid any damage caused by condensation.

Keyword list

Pressure loss

Inlet and outlet resistance per radiator for water flow rates of up to 1 m/s $\zeta = 3,0$.

The pressure losses of the presettable standard valve sets to be taken into consideration when designing the pump and basic network layout can be taken from the diagrams on the valve characteristics page.

Prices

See General Sales and Delivery Conditions. You can find these under "Legal notice" on our homepage at www.international.zehnder-systems.com.

Product description

At the beginning of each chapter is a description of the radiator together with its product-specific benefits and applications.

Protected areas

The provisions of VDE 0100 must be observed when installing radiators with electric heating elements in wet rooms. Examples of the protected area classification for electrical equipment according to VDE 0100 PART 701 for baths and showers.

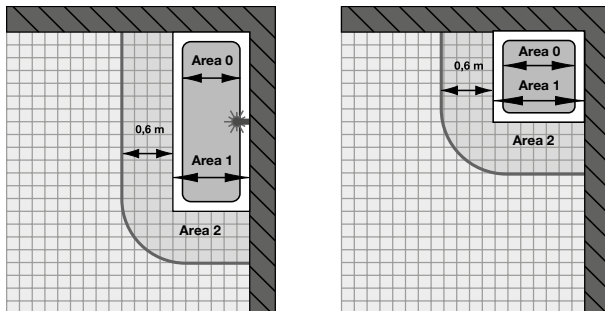

Areas 0 and 1:

Comprise the inside and surrounding areas of bath tubs and shower trays, area 1 ends at the outer edge of the tub/tray. No radiators with electric heating elements must be installed or connected in these areas.

Area 2:

Radiators with electric heating elements can be installed and connected here. The electric heating elements and the connection must have at least degree of protection IPX4 (WIVAR II, WIVAR Hotel, RICA, DBM, RACY).

If the connection is made via a plug and socket, the socket must be outside of areas 0, 1 and 2.

Quality check

Zehnder Group Deutschland GmbH is certified to DIN ISO 9001 and is therefore subject to stringent quality controls carried out by independent institutions in the areas of Design/Development, Production, Assembly and Customer Service.

Room divider

An overview of how the designer bathroom radiator can be used as a room divider is provided by the following table. Detailed information can be found in the respective product chapters.

Product/product family	Room divider
Zehnder Alban	-
Zehnder Archibald	-
Zehnder Arteplano	-
Zehnder Chime	-
Zehnder Deseo Verso	-
Zehnder Fain	X
Zehnder Folio Belt	-
Zehnder Folio Glass	-
Zehnder Folio Hybrid	-
Zehnder Yucca	-
Zehnder Yucca Asym	X
Zehnder Charleston	-
Zehnder Metropolitan	-
Zehnder Kazeane	-
Zehnder Roda Spa Asym	-
Zehnder Quaro	X
Zehnder Subway	X
Zehnder Toga	X
Zehnder Forma	-
Zehnder Klaro	-
Zehnder Stalox	-
Zehnder Aura	-
Zehnder Bluebell	-
Zehnder Virando	-
Zehnder Impa	-
Zehnder Zeta	-

Keyword list

Reduced output

The thermal output can be affected depending on where the radiator is installed. The nominal heat output is measured in an unobstructed setting with a ground clearance of 110 mm and a wall clearance of 50 mm. Any reduction in these clearances, as well as installation in alcoves and the application of covers and grilles can, depending on the model, lead to a reduction in thermal output.

Standard water flow q_{ms}

(heating agent flow, flow quantity, mass flow)

The nominal flow rate q_{ms} of a radiator gives a temperature spread of 10 K at a flow temperature of 75°C (standard thermal output conditions).

$$q_{ms} = \frac{\Phi}{c_p (t_1 - t_2)} \quad c_p \approx 4187 \frac{\text{J}}{\text{kg} \cdot \text{K}}$$

The actual water flow q_m of a radiator can, at flow and return temperatures other than 75/65°C, deviate significantly from the nominal flow rate q_{ms} .

Example

Zehnder Universal

$\Phi_s = 1093 \text{ W}$ (at 55/45/24: 483 W)

Model HU-180-60

Temperatures: 55/40/24 °C

$$q_{ms} = \frac{483}{4187 (55-40)} \quad q_m = 0.015 \text{ kg/s} \approx 41.5 \text{ kg/h}$$

The actual mass flow q_m is therefore still:

$$q_m \text{ in } \% = \frac{q_m}{q_{ms}}$$

$$q_m \text{ in } \% = \frac{41.5}{116.5}$$

$$q_m \text{ in } \% = 36\% \text{ from } q_{ms} > 27\%$$

minimum according to table: 27%.

The example therefore satisfies the guideline for the minimum water flow; see also minimum water flow.

Registration

Zehnder radiators are tested to EN 442 and comply with this standard.

Returns

Radiators and accessories cannot be returned.

Return connection

This concerns the connection on the radiator through which the hot water leaves the radiator and passes along the return line to the heat generator.

Scope of delivery

The scope of delivery for the standard version of a radiator can be found in the respective product description.

Seals

In the case of sealed connections and plugs, it may be necessary to tighten up the connection and blanking plugs depending on the water quality, e.g. in a connection to district heating, after testing the pressure or heating the system for the first time. The sealing materials supplied or used by Zehnder are intended for use in closed heating systems.

Single-pipe systems

Only possible with valves for vertical installation. We recommend using single-tube valves with an adjustable by-pass or a riser, i.e. with an adjustable water volume above the radiator. Only single-tube valves with baffle plates of at least 120 mm in length may be used. TKM and Oederlin systems with screw-in turbulators and 150 mm baffle plate. Essentially, a reduced output of at least 25% must be considered when using single-tube baffle plates. Function is often guaranteed only for certain models and up to specific lengths. Maximum lengths and an indication of how the radiators function with various makes of valve is available on request.

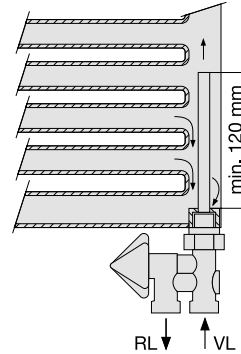

Special finish

Zehnder radiators are available in almost every colour conceivable. The Zehnder colour chart shows a selection of the possible colours from various colour systems, such as RAL colours, sanitary colours or the NCS-S system.

The standard finish for the entire Zehnder radiator programme is the colour RAL 9016, Traffic White. A further 33 popular colours form Zehnder colour category 1 (see the respective product tables for prices); another 12 form Zehnder colour category 2, with a surcharge on colour category 1. All other paintable colours are available for a surcharge on request.

Another coating option is the clear lacquer version for Zehnder Metropolitan (Technoline), which falls in category 2. This essentially concerns one unique colour for each radiator. For this reason, different surface structures and visual colour differences can also occur at a later point in time.

These colour deviations are not a fault and are therefore not subject to claims under warranty as described in our General Sales and Delivery Conditions.

Special prices apply for highly-polished metal surfaces and metal look. Refer also to the paint and colour chart on the back cover.

Standard data set

The standard data set contains all technical information required by layout programmes. Free data sets can be requested direct from Zehnder or downloaded from the internet (www.international.zehnder-systems.com).

Standard colour and coating

The standard colour for Zehnder radiators is RAL 9016. For more information, see "Finish".

Storage

Zehnder radiators must be stored for the long term or temporarily in dry and chemical-free rooms.

Surface protection

We recommend that installation areas affected by damp or chemicals are only fitted with radiators that are galvanised and then given a powder coating.

For possible applications, see "Galvanisation".

Keyword list

System temperatures

These are the temperatures at which the hot water heating system is operated (flow, return and room temperature).

Test pressure

Each radiator is checked for leaks by subjecting it to 1,3 times its rated maximum operating pressure before delivery. For orders that do not indicate the actual operating pressure, the radiator will be delivered with the operating pressure of the standard version.

Technical specifications

The technical specifications indicated in the documentation are correct at the time of printing. We reserve the right to make amendments that improve the product.

Technoline

See "Special finish"

Tolerances

Industry-standard tolerances and tolerances based on production technology are subject to change for all indicated dimensions and fall within the tolerances defined in EN 442. The maximum tolerance must be considered during pre-assembly of the pipework or fixing materials. We reserve the right to make technical amendments during the validity of the documentation as part of product improvement.

Tender specification

The description of a product is shown in the respective chapter in the product description section.

Thermal output Φ

The thermal output of a radiator model is given by the standard characteristic curve:

$$\Phi = K_M \cdot \Delta T_n$$



EN 442 defines the pan-European test procedure and the measurement method in identically arranged test laboratories.

According to the EN 442 standard, the higher temperature is calculated from the logarithmic mean between flow and return temperature as well as the intake air temperature.

Excess temperature ΔT :

$$\Delta T = \frac{t_1 - t_2}{\ln \left(\frac{t_1 - t_r}{t_2 - t_r} \right)}$$

The thermal output for excess temperatures ΔT other than the standard excess temperature $\Delta T = 50 \text{ K}$ can be calculated via the

$$\Phi = \Phi_s \times \left(\frac{\Delta T}{50 \text{ K}} \right)^n$$

equation.

Example for calculating the thermal output Φ :

$$\begin{aligned} \Phi_s &= 1024 \text{ W} \\ n &= 1,30 = \text{exponent} \\ t_1 &= 60^\circ\text{C} \\ t_2 &= 40^\circ\text{C} \\ t_r &= 24^\circ\text{C} \end{aligned}$$

$$\Delta T = \frac{60 - 40}{\ln \left(\frac{60 - 24}{40 - 24} \right)} = 24,7 \text{ K}$$

$$\Phi = 1024 \text{ W} \times \left(\frac{24,7 \text{ K}}{50 \text{ K}} \right)^{1,30} = 1024 \text{ W} \times 0,40 = 409 \text{ W}$$

also see "Nominal heat output"

VDI 6036

Application of the directive VDI 6036 assists all participants in the process to make a comprehensive and comparable assessment of the installation situation. As an accepted rule of technology, this directive and the resulting assessment can also be drawn on for regulation purposes in the event of damages. Directive VDI 6036 classifies applications for radiator fastenings into various requirements classes with different loads. Additional loads for various intensities of misuse can be added to the net weight and water content of the radiator as required. Zehnder publishes a recommendation for the allocation of selected fixing elements – provided not labelled otherwise – by standard for the requirements classes 1 and 2 and stable wall structures (e.g. concrete). Assignment recommendations for requirements class 3 and for special custom applications (requirements class 4) on request.

Example applications from VDI 6036:

Requirements class 1 and 2 (normal and increased requirements): owner-occupied homes, rented flats, kindergartens, hospitals, retirement and nursing homes, office buildings, doctors' surgeries/lawyers offices, retail outlets.

Requirements class 3 (high-level requirements): schools, sports facilities, youth centres, meeting places, railway stations, barracks

Requirements class 4 (very high-level requirements or special burdens):

prisons, psychiatric institutions, special agreements

Wall clearance

This is the distance between the wall and the back of the radiator. For more information, see "Reduced output".

Warranty

See our warranty conditions in 8.2 of our General Sales and Delivery Conditions (www.international.zehnder-systems.com), the warranty period for the products shown in the Price List is 5 years, and for electrical components just 2 years.

Water quality

Operating conditions and water quality according to VDI 2035 must be maintained.

Claims under guarantee will be rejected if substances (e.g. chemicals, antifreeze, etc.) which have an aggressive effect on the sealing material are added to the heating water.

In case of non-compliance, no liability can be accepted in accordance with point 8 of our General Sales and Delivery Conditions for sealing material, nor for any resulting defects and consequences.

Claims under guarantee in accordance with point 8 of our General Sales and Delivery Conditions will also be rendered invalid in case of:

- Operation with steam,
- Periodical or long-term emptying of the system,
- Excessive sludge in the radiators and
- Occasional or constant see page of oxygen into the system.

Wet rooms

See "Surface protection"

WEEE Statement

This product may not be treated as household waste. Instead it should be handed to an appropriate collection point for the recycling of electrical and electronic equipment. For more detailed information about the recycling of this product, please contact your local council office or your household waste disposal service.



Keyword list

Legend		
Icon	Unit	Description
H	mm	Height
L	mm	Length
T	mm	Depth
H Lam.	mm	Height of fins
N	mm	Connection centre
A	m ²	Surface
V	dm ³	Water content
M	kg	Empty weight
t ₁	°C	Flow temperature
t ₂	°C	Return temperature
t _r	°C	Indoor air temperature
t _m	°C	Average water temperature (t ₁ +t ₂)/2
ΔT _n	K	Standard excess temperature t _m - t _r
ΔT	K	Excess temperature t _m - t _r
Φ	W=(J/s)	Thermal output
Φ _s	W	Nominal heat output
Φ _L	W	Nominal heat output of module
c _p	J/(kg K)	Mean specific heat capacity
n	-	Radiator indicator, exponent
s _k	%	Proportion of radiation
c _k	-	Conversion factor to Φ _s
q _m	kg/h/(kg/s)	Water flow
q _{ms}	kg/h/(kg/s)	Nominal flow rate
v	m/s	Velocity
Δp	kPa	Pressure loss, pressure drop
ζ	-	Coefficient of resistance
ln	-	Natural logarithm

Physical unit	
°C	Degrees, Celsius
K	Kelvin, unit for temperature difference
m	Metres
mm	Millimetres
m/s	Metres/second, flow rate
Pa	Pascal, 1 Pa = 0,102 mmWS
mmWS	mm water column
W	Watt, unit of power 1 W = 0,6 kilocalories/hour, 1 W = 1 J/s old unit of power, 1 kcal/h = 1,163 W
c	Specific heat capacity of water = 1 kcal/(kg K) = 4,187 kJ/kg K
kJ	Kilojoule, 1 kJ = 0,239 kcal

Functional principle



1. Fresh air is fed into the system via an external wall vent. The fresh outdoor air can optionally flow through the Zehnder ComfoFond-L sub-soil heat exchanger, which uses geothermal energy to pre-temper the outdoor air.

2. The Zehnder ComfoAir ventilation unit recovers up to 95% of the energy from the extract air and returns it to the fresh air. This can be humidified, dehumidified and pre-tempered using optional components.

3. The Zehnder ComfoFresh air distribution system channels fresh air at the right temperature to individual rooms as needed and vents the extract air to the outside. The air volume can be individually adjusted for each room.



Air distribution system – effective and hygienic

The perfect addition to comfort ventilation units: This harmonised system supplies fresh air to all rooms and removes stale, moist, contaminated air and odours. It is simple and flexible to install, quiet and faultless to operate.

Variants with round or flat oval tubes are available for the air distribution. So you can be highly flexible when handling any build situation. Both can be integrated easily into the building and fitted with speed. Simply select the best variant for you – or combine the two if that makes more sense.

The air distribution system with flat oval tube for cover, wall and floor (Zehnder OnFloor)



The air distribution system with round tube for cover, wall and floor (Zehnder InFloor)

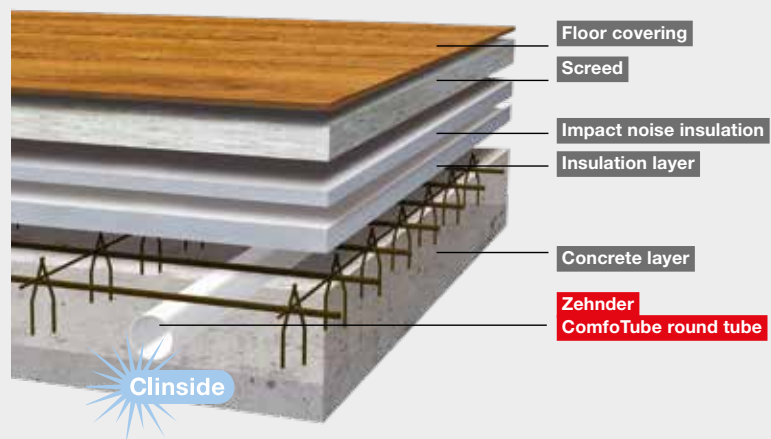

- Installation friendly, flexible tubes
- High-quality food grade plastic (HDPE)
- Clinside smooth inner skin for clean tubes
- Centrally and peripherally adjustable airflow rates
- Low pressure loss
- Easy to clean



Clean due to Clinside: The smooth inner skin prevents the build-up of dust. Cleaning is easy.

Clinside Tested cleaning ability

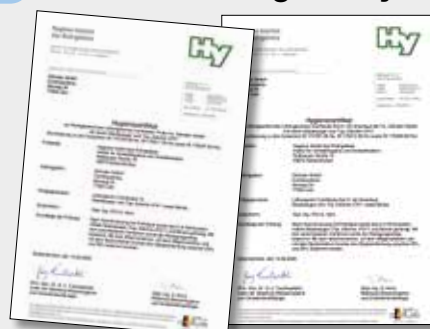

Certificates issued by a recognised hygiene institute.

Comfortable indoor ventilation from Zehnder

Benefits

- Optimum fresh air supply helps you stay healthy
- Hypo-allergenic
- Filtering out pollutants
- Retention of the property's value by preventing mould from developing in the building's basic structure
- Energy saving through heat recovery
- Protects against outside noise



Zehnder ComfoAir ventilation units

- For use in demanding residential and commercial buildings
- Up to 95% heat recovery by cross-counterflow heat exchanger
- Fans with extremely efficient EC motors
- 100% automatic by-pass
- Option: Electric pre-heater or enthalpy exchanger



Zehnder ComfoAir Q350 TR



Passive house certified

Zehnder designer grilles

- Elegant and discreet
- For every interior
- Surface-mounted and flush-mounted version
- Available in white or stainless steel
- Suitable for displacement ventilation



Zehnder Roma



Zehnder Pisa



Zehnder Torino



Zehnder Venezia



Zehnder Sans soucis



Zehnder Sacré coeur

Warm colours

Colour category 1: CORE



White Quartz
0521

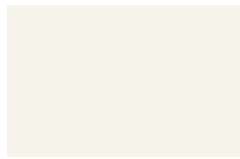

Pure White
RAL 9010 / 9010

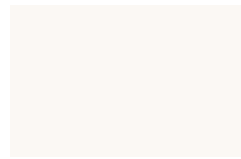

Edelweiss
0067

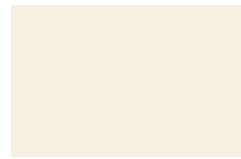

Cream
RAL 9001 / 9001



Telegrey 4
RAL 7047 / 7247

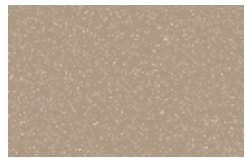

Beige Quartz
0523



Golden Sand
0258



Yellow Grey
RAL 7034 / 7234

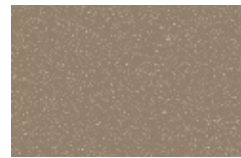

Pearl Beige
RAL 1035 / 1235



Beach Gold
0272



Concrete Grey
0265

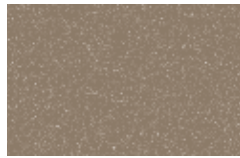

Beige Grey
0267



Bronze
0276

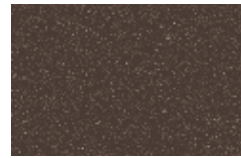

Brown Quartz
0529



Dark Brown
0270

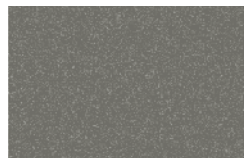

Grey Aluminium
9007

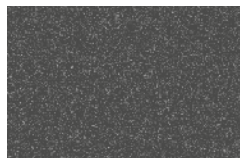

Anthracite
0346



Umbra Grey
RAL 7022 / 7222



Volcanic
0336



Colour category 2: TREND

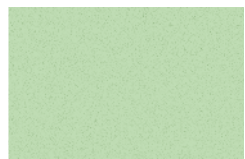

Pastel Green
RAL 6019 / 6219



Reseda Green
RAL 6011 / 6211



Cement Grey
RAL 7033 / 7233



Olive Green
RAL 6003 / 6203



Terracotta Faded
0299



Terracotta
0292



Ruby Red
RAL 3003 / 3003



Surcharge for colour category 2: 146,76 €

⚠ Unlike to the colour standard (here RAL tone) the Zehnder no. also includes the features matt respectively glossy. Therefore the RAL standard and Zehnder no. differ in many colours. Please note that the prices always relate to the given finishes matt or glossy, deviating finishes will be calculated like colours outside of the colour cart. These colours are finished with a gloss finish; all other colours are matt-finished.

Other special finishes in the RAL, RAL-D, NCS-S, Sanitary, DB colour systems are available as required, surcharges on request.

Cool colours

Colour category 1: CORE

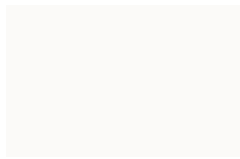

White Matt
0556

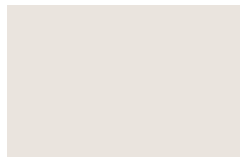

Light Beige
0253



Light Grey
0262



White Aluminium
9006



Light Jeans
0264

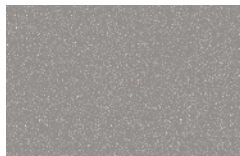

Titane
0335



Inox Look
0332

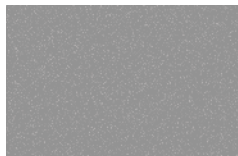

Telegrey 2
RAL 7046 / 7246



Blue Grey
RAL 7031 / 7231



Anthracite Grey
RAL 7016 / 7016



Black Quartz
0550

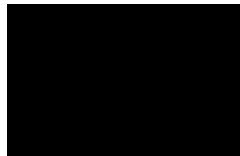

Black Matt
0557

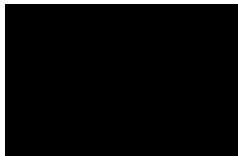

Traffic Black
RAL 9017 / 9217

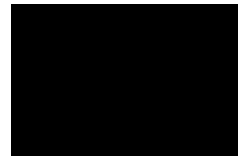

Jet Black
RAL 9005 / 9005



Colour category 2: TREND



Pastel Blue
RAL 5024 / 5224



Pigeon Blue
RAL 5014 / 5214



Gentian Blue
RAL 5010 / 5210



Sapphire Blue
RAL 5003 / 5203



Blue Night
0289

Surcharge for colour category 2: 146,76 €

STANDARD



Traffic White
RAL 9016 / 9016



FINISHES



Technoline (Clear)
0325



Chrome (Surface)
0008



Stainless steel brushed
9517

Some colours/surfaces are only available for selected products. Please also see the notes on the respective product pages. For Special surfaces of the Studio Collection, please see the respective product chapters. Special colours on request. Due to different manufacturing techniques of the original colours, deviations can occur in colour and polish. RAL and NCS are designations from the manufacturer. The respective colour code (ED) is set at the 9th and 10th places in the article no.



Zehnder
World of Colours