

# Zehnder Roda Electric

Prices and Technology 2023 - Sales International

always the best climate

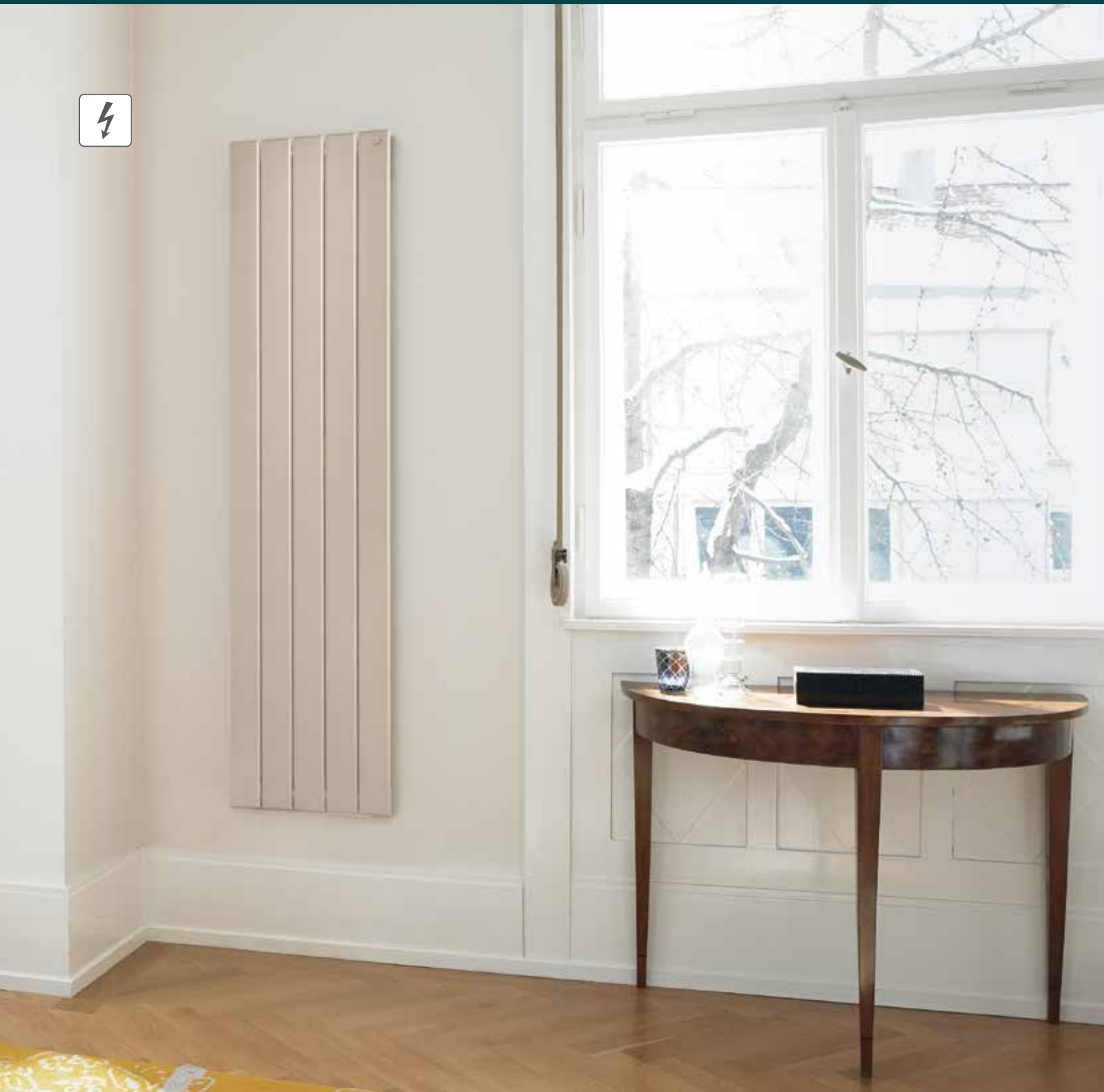

## ALWAYS THE BEST CLIMATE

**“We strive to improve the quality of life by providing the finest indoor climate solutions.”**



### **Excellent team**

Every day we combine passion, expert knowledge and commitment to give you the best results.



### **Great solutions, products and services**

Great products and unique service for an energy-efficient, healthy and comfortable indoor climate.

## WE ARE THE SPECIALISTS FOR A HEALTHY, COMFORTABLE AND ENERGY-EFFICIENT

The broad and clearly structured portfolio from the Zehnder Group is split into five product lines. Consequently, we can provide our customers with the right product, perfect system and matching service for all types of projects – from new build to renovations, single or multi-occupancy homes, as well as commercial projects. This variety ensures that our wealth of experience is continuously expanding, providing tangible added value to our customers on a daily basis.



### **Comfortable indoor ventilation**

Our comfortable indoor ventilation is energy-efficient and provides a healthy indoor climate. It promotes the wellbeing of the occupants and increases the value of the property.

## OUR BRAND REPRESENTS INNOVATION, QUALITY AND DESIGN

**zehnder**

The Zehnder brand offers excellent indoor climate solutions within the product lines of decorative radiators, comfortable indoor ventilation, heating and cooling ceiling and clean air solutions.

## INNOVATION OVER 5 GENERATIONS



**First choice for customers**  
Always close to the needs of our customers, to grow with you and overcome all challenges together.

MANUFACTURER OF THE WORLD'S

**1<sup>st</sup>**

STEEL AND BATHROOM RADIATORS

REPRESENTED IN MORE THAN

**70** COUNTRIES

AROUND

**3,500**

EMPLOYEES

**17** OF OUR OWN PRODUCTION PLANTS IN EUROPE, NORTH AMERICA AND CHINA

INNOVATION SINCE **1895**

**900** PATENTS AND DESIGN RIGHTS THROUGHOUT THE WORLD

AROUND **40,000**

TRAINED CUSTOMERS PER YEAR

## INDOOR CLIMATE



**Decorative radiators**  
Our individual decorative radiators make every room – whether at home or in commercial or public buildings – not only warmer, but also more attractive. They combine iconic design with outstanding comfort experience.



**Heating and cooling ceiling**  
The ceiling is the perfect place to supply a room with convenient heating and cooling. Energy-efficient climate via radiant panels work perfectly with our suite of solutions from office to manufacturing spaces.



**Clean air solutions**  
Air cleaning systems from Zehnder effectively reduce the amount of dust and other particles in the air. The result: clean working environments, significantly improved employee health and enhanced business performance.

## BEST QUALITY CERTIFICATES

Zehnder Group products are frequently awarded prizes for design and innovative technology.

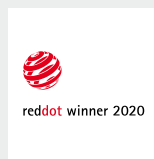
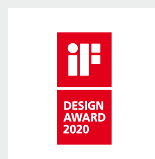

**General Sales and Delivery Conditions:**

Our General Sales and Delivery Conditions apply. You can find these under “Legal notice” on our homepage at [www.international.zehnder-systems.com](http://www.international.zehnder-systems.com).

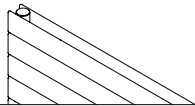
Electric radiator	Zehnder Roda			5
Accessories	Zehnder rails and hooks			
	Zehnder Miscellaneous			14
General	Keyword list			
	Pressure loss graph, conversion table			16
	Zehnder comfortable indoor ventilation			



# Zehnder Roda Electric

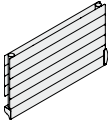

	Overview of models	Product description	Prices / technical specifications	Installation points
<b>Zehnder Roda Electric</b>				
 <ul style="list-style-type: none"> <li>■ Electric radiator</li> <li>■ Steel elements</li> <li>■ Intuitive control panel</li> </ul>	6	8	9	12

**Zehnder Roda Electric ROEHD**

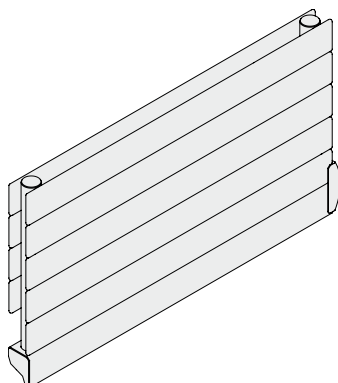

Length <sup>1)</sup> mm	Height mm
	444
817	ROEHD040-080/GF
1117	ROEHD040-110/GF
1517	ROEHD040-150/GF
	592
817	ROEHD060-080/GF
1117	ROEHD060-110/GF
1317	ROEHD060-130/GF
1517	ROEHD060-150/GF

**Zehnder Roda Electric ROEVD**

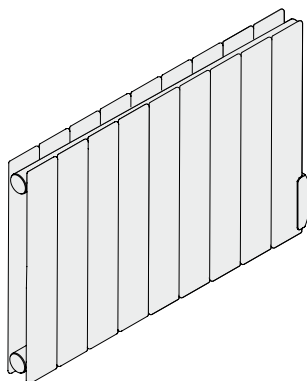

Length <sup>1)</sup> mm	Height mm
	510
609	ROEVD050-060/GF
905	ROEVD050-090/GF
1201	ROEVD050-120/GF
1497	ROEVD050-150/GF
	710
609	ROEVD070-060/GF
831	ROEVD070-080/GF
979	ROEVD070-100/GF
1201	ROEVD070-120/GF
1423	ROEVD070-140/GF

<sup>1)</sup> Total length incl. immersion heater



# Zehnder Roda Electric

---

**Zehnder Roda Electric ROEV**

---

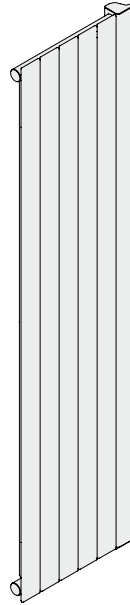

Length mm	Height mm
	1517
368	ROEV150-040/GF
	1817
442	ROEV180-045/GF
590	ROEV180-060/GF
	2017
294	ROEV200-030/GF
368	ROEV200-040/GF
516	ROEV200-050/GF
590	ROEV200-060/GF
738	ROEV200-075/GF
	2217
294	ROEV220-030/GF
442	ROEV220-045/GF
516	ROEV220-050/GF
664	ROEV220-070/GF

# Zehnder Roda Electric



### Product description

Electric Zehnder Roda Electric radiators are efficient decorative radiators, available as horizontal or vertical, perfect for all living areas, and is also available made-to-measure.

### Technical specifications

- Flat tubes 70 x 11 mm, clearance between 4 mm, round manifold tubes Ø 38 mm
- Standard version primed and painted in RAL 9016
- Fixing: Delivered ready to install with wall brackets in colour of radiator.
- Connection cable without plug, appliance class II
- Pilot cable integrated
- With integrated electric heating element and remote control
- Protection class IP44
- Supply voltage: 230 V

### Advantages

- Energy-efficient and comfortable heating via innovative “open window detection”
- High energy efficiency due to compliance with the European EcoDesign Directive saves energy costs
- Low energy consumption of only 0,5 W in stand-by mode for increased energy efficiency
- User-friendly remote control device allows simple operation
- Comfortable operation as needed by customisable daily and weekly programme
- Timer function for on-demand operation
- Increased safety due to parental control

### Standard scope of delivery:

- Primed and painted in RAL 9016
- Remote control device in white
- Connecting cable 1,20 m without plug
- Mounting accessories
- Packaging



Control unit radio remote-controlled Model 2

# Zehnder Roda Electric

## Zehnder Roda Electric ROEHD

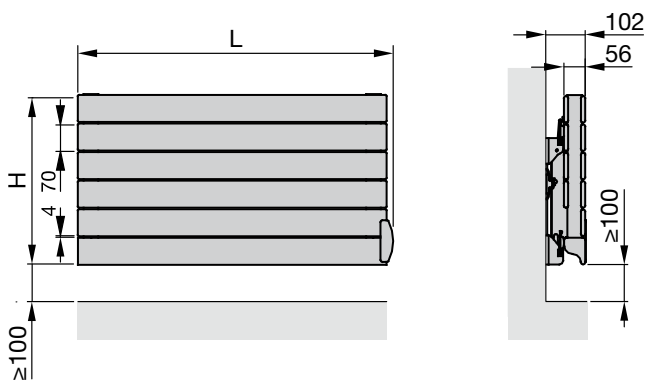

H = Height  
 L = Length  
 T = Depth of radiator  
 M = Weight

Dimensions in mm

### Prices and technical specifications per radiator

Model	Price <sup>1)</sup> RAL 9016 €	H mm	L <sup>2)</sup> mm	T mm	M kg	Output Electric heating element Watt
ROEHD040-080/GF	<b>1.312,55</b>	442	817	56	21,5	750
ROEHD040-110/GF	<b>1.398,18</b>	442	1117	56	28,3	1000
ROEHD040-150/GF	<b>1.515,95</b>	442	1517	56	37,7	1500
ROEHD060-080/GF	<b>1.430,40</b>	590	817	56	28,7	1000
ROEHD060-110/GF	<b>1.536,71</b>	590	1117	56	38,5	1250
ROEHD060-130/GF	<b>1.618,27</b>	590	1317	56	44,8	1500
ROEHD060-150/GF	<b>1.692,76</b>	590	1517	56	50,4	2000

<sup>1)</sup> Surcharge for special colour, category 1 = 20%; category 2 = 30%

<sup>2)</sup> Total length incl. immersion heater

# Zehnder Roda Electric



## Zehnder Roda Electric ROEVD

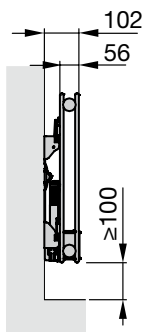
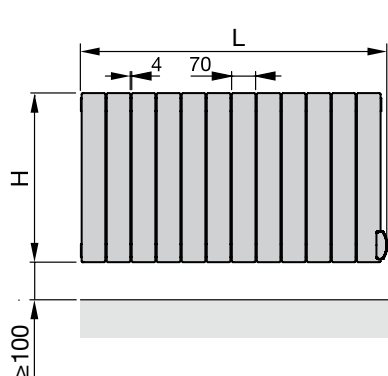

- H = Height
- L = Length
- T = Depth of radiator
- M = Weight

Dimensions in mm

### Prices and technical specifications per radiator

Model	Price <sup>1)</sup> RAL 9016 €	H mm	L <sup>2)</sup> mm	T mm	M kg	Output Electric heating element Watt
ROEVD050-060/GF	<b>1.280,45</b>	500	609	56	24	500
ROEVD050-090/GF	<b>1.440,58</b>	500	905	56	34	750
ROEVD050-120/GF	<b>1.604,58</b>	500	1201	56	45	1000
ROEVD050-150/GF	<b>1.753,73</b>	500	1497	56	56	1250
ROEVD070-060/GF	<b>1.381,18</b>	700	609	56	29	750
ROEVD070-080/GF	<b>1.521,98</b>	700	831	56	39	1000
ROEVD070-100/GF	<b>1.619,42</b>	700	979	56	46	1250
ROEVD070-120/GF	<b>1.773,70</b>	700	1201	56	56	1500
ROEVD070-140/GF	<b>1.917,69</b>	700	1423	56	66	1750

<sup>1)</sup> Surcharge for special colour, category 1 = 20%; category 2 = 30%

<sup>2)</sup> Total length incl. immersion heater

# Zehnder Roda Electric

## Zehnder Roda Electric ROEV

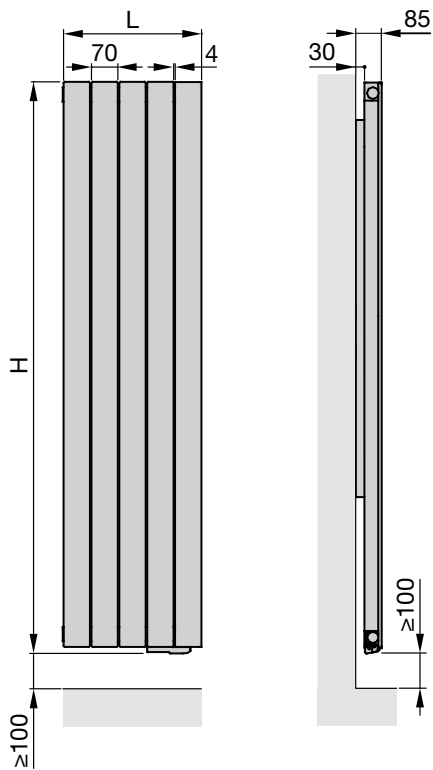

H = Height  
 L = Length  
 T = Depth of radiator  
 M = Weight

Dimensions in mm

### Prices and technical specifications per radiator

Model	Price <sup>1)</sup> RAL 9016 €	H <sup>2)</sup> mm	L mm	T mm	M kg	Output Electric heating element Watt
ROEV150-040/GF	<b>1.606,14</b>	1517	375	55	24	750
ROEV180-045/GF	<b>1.763,79</b>	1817	449	55	32	1000
ROEV180-060/GF	<b>1.917,39</b>	1817	597	55	40	1500
ROEV200-030/GF	<b>1.529,75</b>	2017	301	55	26	750
ROEV200-040/GF	<b>1.594,98</b>	2017	375	55	31	1000
ROEV200-050/GF	<b>1.738,90</b>	2017	523	55	40	1250
ROEV200-060/GF	<b>1.816,62</b>	2017	597	55	44	1500
ROEV200-075/GF	<b>1.962,96</b>	2017	745	55	53	2000
ROEV220-030/GF	<b>1.590,10</b>	2217	301	55	29	1000
ROEV220-045/GF	<b>1.736,36</b>	2217	449	55	39	1250
ROEV220-050/GF	<b>1.819,65</b>	2217	523	55	44	1500
ROEV220-070/GF	<b>2.168,08</b>	2217	671	55	53	2000

<sup>1)</sup> Surcharge for special colour, category 1 = 20%; category 2 = 30%

<sup>2)</sup> Total height incl. immersion heater

Drilling ROEHD				Fixation	
6 Tubes	A	B	C		
750 W	150	400	127		
1000 W	350	400	127		
1500 W	350	800	127		
8 Tubes	A	B	C		
1000 W	150	400	143		
1250 W	350	400	143		
1500 W	250	800	143		
2000 W	350	800	143		

Drilling ROEVD					Fixation	
H 500 mm	A	B	C	D		
500 W	185	148	143	290		
750 W	222	407	143	290		
1000 W	111	814	143	290		
1500 W	333	814	143	290		
H 700 mm	A	B	C	D		
500 W	111	148	123	444		
750 W	185	148	123	444		
1000 W	148	407	123	444		
1250 W	296	407	123	444		
1500 W	111	814	123	444		
1750 W	259	814	123	444		

Dimensions in mm

# Zehnder Roda Electric

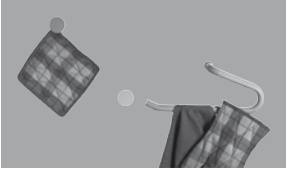

Drilling ROEV		Fixation															
		<p>Easy to install by hinged mounting brackets</p>															
<table border="1" style="margin: auto; border-collapse: collapse;"> <thead> <tr style="background-color: #cccccc;"> <th>H</th> <th>X</th> <th>Y</th> </tr> </thead> <tbody> <tr> <td>1500</td> <td>700</td> <td>500</td> </tr> <tr> <td>1800</td> <td>1000</td> <td>800</td> </tr> <tr> <td>2000</td> <td>1200</td> <td>1000</td> </tr> <tr> <td>2200</td> <td>1400</td> <td>1200</td> </tr> </tbody> </table>		H	X	Y	1500	700	500	1800	1000	800	2000	1200	1000	2200	1400	1200	
H	X	Y															
1500	700	500															
1800	1000	800															
2000	1200	1000															
2200	1400	1200															

## Rails and hooks

Description	Image	Version	Article number	Price €	Application
<b>Pair of towel hook</b> Ø 50 mm		White Chrome Special finish	480891 480718 480899	<b>143,33</b> <b>174,56</b> <b>185,73</b>	Zehnder Roda Electric (only ROH and ROV)
<b>Hook set</b> 2 pegs and 1 towel rail		White Special finish	480751 480759	<b>190,43</b> <b>217,71</b>	Zehnder Roda Electric (only ROH and ROV)



## Miscellaneous

Description		Version	Article number	Price €	Application
<b>Lacquer aerosol</b> Original paint, air-drying For improving the surface finish, 150 ml RAL 9001 (Cream White) RAL 9002 (Grey White) RAL 9010 (Pure White) RAL 9016 (Traffic White)		Colour:  RAL 9001 RAL 9002 RAL 9010 RAL 9016	  977020 977050 977080 977090	  <b>30,75</b> <b>30,75</b> <b>30,75</b> <b>30,75</b>	
<b>Lacquer pens</b> Original paint, air-drying For repairing minor damage  RAL 9010 (Pure White) RAL 9016 (Traffic White)		Colour:  RAL 9010 RAL 9016 On request	  675020 675130 675000	  <b>26,18</b> <b>26,18</b> <b>26,18</b>	

# Keyword list

## Accessories

A wide range of accessories are available for various additional uses, such as hanging up towels. For more information, see the section on "Accessories".

## Accessory set

To make accessories simple to choose, accessory sets are offered for each radiator. Detailed information is provided in the relevant section.

## Baffle

To avoid reduced output, e.g. with a riding connection, internal installations, e.g. baffles, deflector plates, guide plates, are required. Detailed information is available on request.

## Advantages

See "Product description".

## Brackets

Appropriate brackets are offered as an accessory set for the respective radiators. Detailed information is given alongside the relevant products and in the "Accessories" section. Also see notes under "Fixings".

## CE marking

The CE marking on Zehnder radiators shows that they are manufactured in accordance with the prevailing European standard EN 442 and that the product has been subjected to the prescribed conformity evaluation procedure.



The following parameters, which allow the CE mark to be shown, can be found in the respective product section:

- Model designation
- Max. operating pressure
- Nominal heat output

Product/product family	CE - Year
Zehnder Roda electrical version	CE - 17

## Clear Lacquer Version (Technoline)

See "Colours"

## Connections

Each Zehnder radiator is supplied complete with connections. Unless stated otherwise, all connections are female threads. Unless a different dimension is specified, the supplied connections are 1/2". Orders without a connection type number will always be delivered with the respective standard connection. Plastic plugs inserted to protect the thread must be removed and replaced with an directional air vent / draining valve or blind plug.

## Conversion

Factor for converting the nominal heat output to thermal outputs at other system temperatures, see "Thermal output".

## Corrosion protection

See "Finish" and "Surface protection".

## Colours

Zehnder radiators are available in almost every colour conceivable. From all possible colours, the Zehnder colour chart shows a selection of colours from various colour systems, such as RAL colours, sanitary colours or colours from the NCS-S system. The standard paint for the entire Zehnder radiator programme is the colour RAL 9016, Traffic White. 33 common colours make up Zehnder colour category 1, with an additional charge of 20%, 12 others colour make up category 2, with an additional charge of 30% on the standard finish. All other paintable colours are available for a surcharge on request. These colour deviations are not a fault and are therefore not subject to

claims under warranty as described in our "General Sales and Delivery Conditions".

Structural paints (structured paint surface) are possible on Zehnder radiators and also fall under category 2.

The Zehnder colour chart is printed on the inside of the rear catalogue cover.

For more information, see "Finish".

## Description

The description for a product contains all the information needed to create a specification or tender. The text-block structure simplifies the composition of all necessary features according to on-site requirements.

## Dimensions

The dimensions indicated in the documentation are correct at the time of printing. Subject to change without notice.

## Electric radiators and EcoDesign guidelines

The electric guidelines define fixed units consisting of a corpus, a filling medium (heat transfer liquid), a heating insert and a matching control device. This unit is the base for a function test and it may not be modified.

The heat transfer liquid is frost proof up to -20 °C, if there are no further restrictions listed in the standard scope of delivery for the corresponding radiator.

Electric radiators are subject to the EcoDesign guidelines. Aim of this guideline is the reduction of environmental impacts of relevant energy consumption production taking the product lifecycle into consideration. The fulfillment of the guideline is rated according a specific points system. Different functions are e.g. stand-by mode ≤ 05 W weekly program or open-window detection contribute in fulfilling the minimum requirements. The electrical radiators in this price-list match the EcoDesign guidelines.

Please note:

- The electrical installations need to be accordance with local guidelines.
- For fixed installations (without plug) a switch needs to be installed. (All poles of the power supply with min 3m contact distance.)
- The filling capacity may not be altered.
- The electric heating element and connection cable may only be opened and replaced by the manufacturer.
- When installing an electrical radiator, a qualified electrician is the competent person to contact.
- Follow the user manual precisely.

## Environment

The certification of our environmental management system to DIN EN ISO 14 001 by an independent institution obliges us to make continuous improvements to our environmental services through reducing or avoiding environmental burdens and waste, encouraging the utilisation and protection of resources as well as observing all environmental laws and regulations applicable to us.

## Finish

Ready-painted radiators in this price list have a two-coat finish (to DIN 55900, Part 1 and 2, comprising primer and top coat). The top coat is a powder coating. The high-quality Zehnder powder coating produces an especially smooth and extremely durable surface. Further information on the applications and limits of radiators is contained in information sheet number 7 of the BDH (Bundesindustrieverband Deutschland, Haus-, Energie- und Umwelttechnik e.V.).

Please always use the original RAL, NCS colour samples or original colour charts of the sanitary manufacturers for exact colour matching. For technical production reasons, minor colour deviations are possible in paints on steel surfaces, also when taking the prevailing lighting conditions into account. Deviations can also occur when comparing painted steel surfaces (radiators) with ceramic products.

# Keyword list

The colours shown here (see inside of rear cover) are not binding for printing reasons. Radiators in metallic colours, e.g. RAL 9006, RAL 9007 and Anthracite are unique products and visual differences may appear in the colour, depending on the radiator.

## Fixings

To increase the convective thermal output, convection fins are used.

## Flow connection

To ensure that radiators are fitted safely, the weight of the radiator and other aspects must be considered when choosing the right quality and quantity of fixings. Additional loads and foreseeable misuse of a radiator must be considered or ruled out by planning and implementation in line with the known building use. The installation situation and accessibility are just as important criteria as wall material, bracket shape, location of the suspension points, locking device, add-on elements and the like.

Detailed information on the required number of fixing axes in accordance with VDI 6036 requirements class 2 is given for the respective products in the section on "Installation accessories". Recommendations for additional requirements classes on request. See also the key word VDI 6036.

## Galvanising

This concerns the connection on the radiator through which the hot water flows into the radiator.

## Ground clearance

A reduction in the distance between the radiator and the floor can result in reduced output. For more information, see "Reduced output".

## Guide plate

See "Baffle".

## High pressure

Even with suitable radiators and accessory parts, pressure loads up to a maximum of 18 bar are only permitted if pressure surges can be excluded.

## Hydraulic balancing

By hydraulic balancing the various system resistances are set so that the radiators are supplied with the necessary quantity of water at all operational points, in order to achieve the desired thermal output.

## Immersion tube

Some types of connection require the installation of an immersion tube to achieve optimal heat distribution.

## Inlet and outlet resistance

The resistance coefficient (zeta value) is used to calculate the pressure loss. For more information, see "Pressure loss".

## Installation in series

The installation in series of radiators refers to the series connection of several radiators. Detailed information is given alongside the relevant products.

## Joining

Zehnder radiators in lengths above the set maximum number of elements are supplied in sub-blocks and must be joined together on site.

## Lance valve

The lances must be shortened or extended, depending on the radiator and connection types. Detailed information is available on request. See keyword "Single-tube systems".

## Length restrictions

Avoiding damage during transport significantly increases the cost of packaging, which must be charged for accordingly.

## Made to measure

Zehnder radiators can be customised (e.g. angled, curved, with welded brackets). Special shapes require templates to be made from solid materials (cardboard, packing paper) in order to guarantee quick and trouble-free processing. The support of the area manager can be used for a small charge.

Where necessary, the customer will receive a scale drawing of the version to be installed and final pricing for inspection and approval, after which the order will be manufactured. The order cannot be cancelled once placed.

## Minimum water flow

If the flow of water through a radiator is heavily reduced, the heat output can fall far below the calculated or indicated value. For this reason, a minimum water flow should always be ensured.

The following table shows the approximate minimum water flows  $q_{m \min}$  in % of the nominal flow rate  $q_{ms}$  which does not cause the thermal output to deviate from the standard characteristic curve by more than 5%.

For some radiators, similar conditions can be reached through additional installations, even at lower water flows as shown in the following table. More information is available on request.

## Operating pressure

The maximum permissible operating pressure of a radiator depends on its geometry, the material used and the finish. The permissible operating pressure varies according to the product, see table:

Suitable fittings, plugs and directional air vents must be ensured in connection with high pressure applications in excess of 10 bar. See "High pressure".

## Operating temperature

The coating of Zehnder radiators can be used for central heating systems up to 110 °C. It is suitable for use in district heating, low temperature and condensing systems.

## Packaging

The packaging of Zehnder radiators serves as protection against damage during transport and on building sites. It must be removed before starting the system for the first time in order to avoid any damage caused by condensation.

## Pressure loss

The pressure loss is determined using a zeta value of 2,5 per radiator for connection sizes from  $\frac{3}{8}$ " to  $\frac{3}{4}$ " and a flow velocity of 1 m/sec. The inherent resistance of a radiator can be ignored. In special cases (e.g. where an integrated valve is fitted), information on pressure losses is provided.

### Prices

Terms of delivery for quoted prices are: FCA Lahr. All prices are gross prices. Where prices are not stated or only shown with the proviso 'current list price', the valid list prices will be calculated on the day of delivery. Also see General Sales and Delivery Conditions.

### Quality check

Zehnder Group Deutschland GmbH is certified to DIN ISO 9001 and is therefore subject to stringent quality controls carried out by independent institutions in the areas of design/development, production, assembly and customer service.

### Reflective cover plates

The disadvantage of installing a radiator in front of external glazing is that heat is lost directly through the glass. The back of a radiator emits heat in the form of thermal radiation in the same way as the front. For wall mounted radiators, the thermal radiation is reflected or absorbed by the wall, whereas this long-wave radiation radiates almost unimpeded through the pane of glass when radiators are installed in front of windows, even at greater distances.

In order to avoid this unnecessary loss of heat and energy, radiators are available with a reflective cover plate fitted to the side of the radiator facing the window.

The requirement for thermal radiation shields previously anchored in the Federal Heat Insulation Ordinance (WVO) is also fulfilled as a result of this.

The installation of thermal radiation shields in front of external glazing is also expedient in times of the Energy Saving Ordinance (EnEV) and is recommended especially with low overall heat transfer resistance on the part of the windows.

### Returns

Radiators and accessories cannot be returned.

### Return connection

This concerns the connection on the radiator through which the hot water leaves the radiator and passes along the return line to the heat generator.

### Safety

See "Statutory Accident Insurer".

### Scope of delivery

The scope of delivery for the standard version of a radiator can be found in the respective product description.

### Seal

In the case of sealed connections and plugs, it may be necessary to tighten up the connection and blind plugs depending on the water quality, e.g. in a remote heating connection, after testing the pressure or heating the system for the first time. The sealing materials supplied or used by Zehnder are intended for use in closed heating systems.

### Single-tube system

We recommend using single-tube valves with an adjustable bypass or a ballast system (riser), i.e. with an adjustable water volume over the radiator. Essentially, a reduced output of at least 25% must be considered when using single-tube lance valves. Function is often guaranteed only for certain models and up to specific lengths. Maximum lengths and an indication of how the radiators function with various makes of valve is available on request.

### Special finish

See "Finish" and "Colours".

### Special versions

Product/product family	angled	bevelled	curved	Galva-nised
Zehnder Roda electrical version	-	-	-	-

### Standard thermal output

The standard thermal output of a radiator is determined in an independent, certified test laboratory according to standard EN 442 at the standard operating temperatures of 75/65/20 °C. The conversion of the thermal output to other system temperatures is done on the basis of the standard thermal output according to EN 12831.

For easy dimensioning, additional outputs for frequently used temperatures are shown alongside the standard thermal output:

- 70/55/20 °C
- 55/45/20 °C

### Standard colour/finish

The standard colour for Zehnder radiators is RAL 9016. Exceptions: Zehnder Fare Tech, Zehnder Alura Tech RAL 9010. For more information, see "Painting".

### Storage

Zehnder radiators must be stored for the long-term or temporarily in dry and chemical-free rooms.

### Structural finish

See "Finish".

### Surface protection

We recommend that installation areas affected by damp or chemicals are only fitted with radiators that are galvanised and then given a powder coating. A polyzinc coating with subsequent powder-coating increases the corrosion protection of the radiator, depending on the surface geometry. Possible applications are available on request. (see also Galvanising)

### System temperatures

These are the temperatures at which the hot water heating system is operated (flow, return and room temperature).

### Technical specifications

The dimensions indicated in the documentation are correct at the time of printing. We reserve the right to make amendments that improve the product.

### Technoline

See "Colours"

### Test pressure

Each radiator is checked for leaks by subjecting it to 1,3 times its rated maximum operating pressure before delivery. For orders that do not indicate the required operating pressure, the radiator will be delivered with the operating pressure of the standard version.

# Keyword list

## Thermal output $\Phi$

The thermal output of a radiator model is given by the standard characteristic curve:

$$\Phi = K_M \cdot \Delta T^n$$



EN 442 defines the test procedure and the measurement method in identically arranged test laboratories. A single, pan-European measuring method therefore replaces the previous measurements that varied from country to country.

The output given under the following conditions in accordance with EN 442 applies as the nominal heat output  $\Phi_s$ :

Flow temperature	$t_1 = 75 \text{ }^\circ\text{C}$
Return temperature	$t_2 = 65 \text{ }^\circ\text{C}$
Mean water temperature	$t_m = 70 \text{ }^\circ\text{C}$
Room temperature	$t_r = 20 \text{ }^\circ\text{C}$
Excess temperature ( $t_m - t_r$ )	$\Delta T = 50 \text{ K}$

## Tolerances

Industry standard tolerances and tolerances based on production technology are subject to change for all indicated dimensions and fall within the tolerances defined in EN 442. The maximum tolerance must be considered during pre-assembly of the pipework or fixing materials. We reserve the right to make technical amendments during the validity of the documentation as part of product improvement.

## VDI 6036

Application of the directive VDI 6036 assists all participants in the process to make a comprehensive and comparable assessment of the installation situation. As an accepted rule of technology, this directive and the resulting assessment can also be drawn on for regulation purposes in the event of damages. Directive VDI 6036 classifies applications for radiator fastenings into various requirements classes with different loads. Additional loads for various intensities of misuse can be added to the net weight and water content of the radiator as required. Zehnder issues standard assignment recommendations for requirements class 2, and for stable wall constructions (e.g. concrete) for selected fixing pieces - unless otherwise marked. Assignment recommendations for requirements class 3 and for special custom applications (requirements class 4) on request.

Example applications from VDI 6036:

**Requirements class 2** (normal and increased requirements): owner-occupied homes, rented flats, kindergartens, hospitals, retirement and nursing homes, office buildings, doctors' surgeries/lawyers offices, retail outlets.

**Requirements class 3** (high-level requirements):

schools, sports facilities, youth centres, meeting places, railway stations, barracks

**Requirements class 4** (very high-level requirements or special burdens): prisons, psychiatric institutions, special agreements

## Wall clearance

This is the distance between the wall and the back of the radiator. For more information, see "Reduced output".

## Warranty

The warranty period shall be sixty (60) months from date of delivery to Buyer. Excluded are electrical radiators, electrical and electronic components. The warranty period for these products is twenty-four (24) months.

## Wetrooms

See "Surface protection"

## Legend

Icon	Unit	Description
H	mm	Height
L	mm	Length
T	mm	Depth
H Lam.	mm	Height of fins
N	mm	Boss spacing
A	m <sup>2</sup>	Surface
V	dm <sup>3</sup>	Water content
M	kg	Empty weight
N <sub>s</sub>	-	Number of elements
t <sub>1</sub>	°C	Flow temperature
t <sub>2</sub>	°C	Return temperature
t <sub>r</sub>	°C	Room air temperature
t <sub>m</sub>	°C	Mean water temperature (t <sub>1</sub> +t <sub>2</sub> )/2
$\Delta T$	K	Excess temperature t <sub>m</sub> - t <sub>r</sub>
$\Phi$	W=(J/s)	Thermal output
$\Phi_s$	W	Nominal heat output
$\Phi_L$	W	Nominal heat output of the module
C <sub>p</sub>	J/(kg K)	Specific heat capacity
n	-	Radiator indicator, exponent
S <sub>k</sub>	%	Proportion of radiation
C <sub>K</sub>	-	Conversion factor to $\Phi_s$
q <sub>m</sub>	kg/h/(kg/s)	Water flow
q <sub>ms</sub>	kg/h/(kg/s)	Nominal flow rate
v	m/s	Velocity
$\Delta p$	kPa	Pressure loss, pressure drop
$\zeta$	-	Resistance coefficient
ln	-	Natural logarithm

## Physical unit

°C	Degrees, Celsius
K	Kelvin, unit for temperature difference
m	Metres
mm	Millimetres
m/s	Metres/second, flow rate
Pa	Pascal, 1 Pa = 0,102 mmWS
mmWS	mm water column
W	Watt, unit of power 1 W = 0,6 kilocalories/hour old unit of power, 1 kcal/h = 1,163 W
c	Specific heat capacity of water = 1 kcal/kg K = 4,187 kJ/kg K
kJ	Kilojoule, 1 kJ = 0,239 kcal

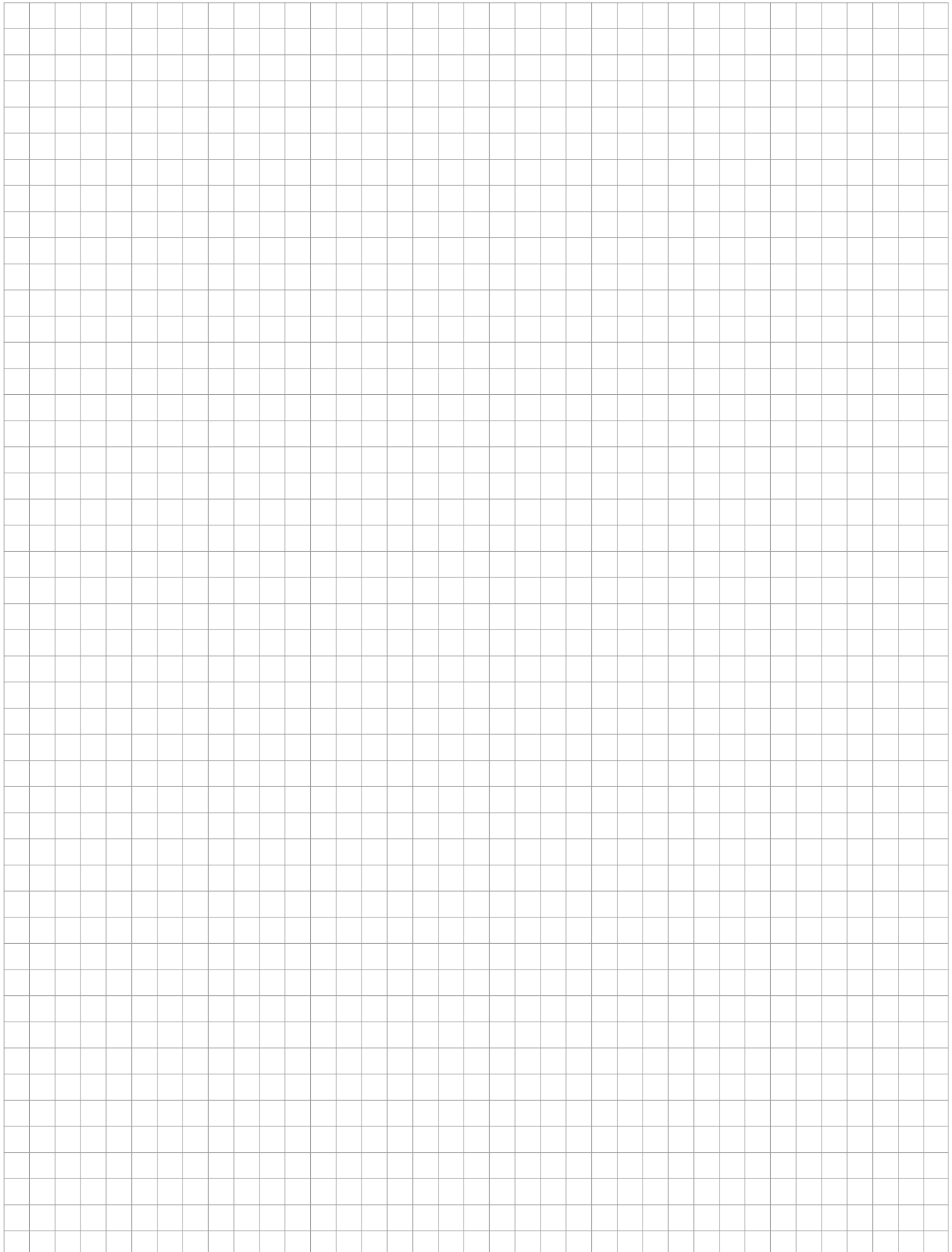
A large, empty grid of small squares occupies the central portion of the page, intended for taking notes. The grid is composed of approximately 30 columns and 40 rows of squares.

# Zehnder comfortable indoor ventilation

## Functional principle

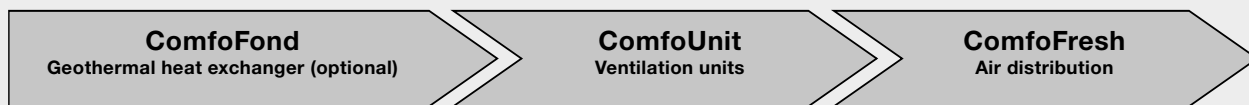

**1.** Fresh air is fed into the system via an external wall vent. The fresh outdoor air can optionally flow through the Zehnder ComfoFond-L sub-soil heat exchanger, which uses geothermal energy to pre-temper the outdoor air.

**2.** The Zehnder ComfoAir ventilation unit recovers up to 95% of the energy from the extract air and returns it to the fresh air. This can be humidified, dehumidified and pre-tempered using optional components.

**3.** The Zehnder ComfoFresh air distribution system channels fresh air at the right temperature to individual rooms as needed and vents the extract air to the outside. The air volume can be individually adjusted for each room.



## Air distribution system – effective and hygienic

There are two versions of air distribution systems available: Zehnder OnFloor and InFloor. In both cases, the volume of air is regulated as required. They are characterised by the ease with which they can be integrated into the building and their rapid installation. In the case of Zehnder OnFloor, fresh air flows through flat, oval ducts with an internal coating, which are installed in the insulation layer of the unfinished floor. Zehnder InFloor functions on the same principle, only the round tubes are laid in the unfinished floor.

Both versions Zehnder InFloor and OnFloor can be combined and thus offer maximum versatility.

The air distribution system with flat tube for cover, wall and floor (Zehnder OnFloor)

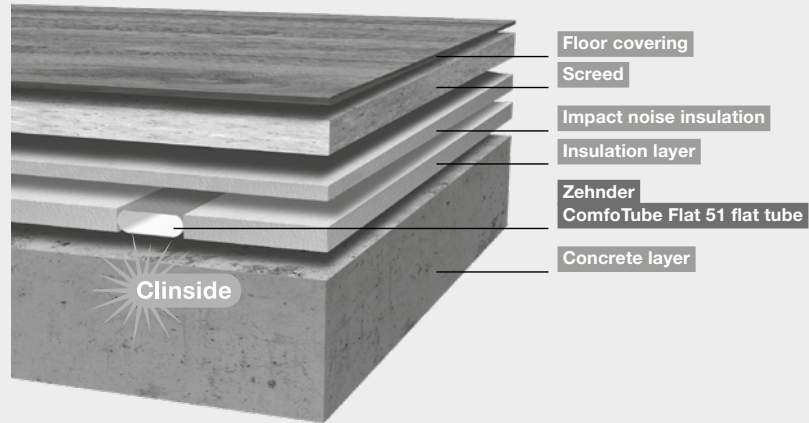

The air distribution system with round tube for cover, wall and floor (Zehnder InFloor)

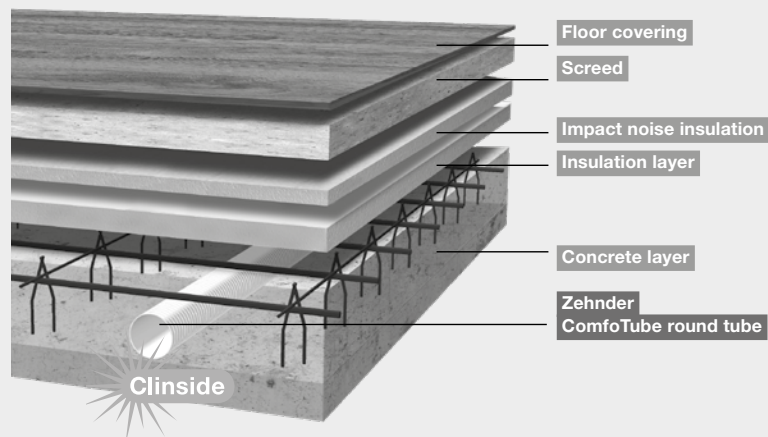

- Easy to install, flexible pipes
- High-quality food grade plastic (HDPE)
- Clinside smooth inner skin for clean tubes
- Centrally and peripherally adjustable airflow rates
- Low pressure loss
- Easy to clean

## Tested cleaning ability

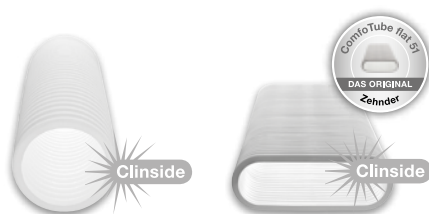

**Clean thanks to Clinside:** The smooth inner skin prevents the build-up of dust. Cleaning is easy.



Certificates issued by a recognised hygiene institute.



# Zehnder comfortable indoor ventilation

## Advantages

- Optimum oxygen and draught-free air supply promote your health
- Hypo-allergenic
- Filtering out pollutants
- Retention of the property's value by preventing mould from developing in the building's basic structure
- Energy saving through heat recovery
- Protects against outside noise



## Zehnder ComfoAir ventilation units

- For use in demanding residential and commercial buildings
- Up to 95% heat recovery by cross-counterflow heat exchanger
- Fans with extremely efficient EC motors
- 100% automatic bypass
- Option: Electric pre-heater or enthalpy exchanger



## Zehnder designer grilles

- Elegant and discreet
- For every interior
- Surface-mounted and flush-mounted version
- Available in white or stainless steel
- Suitable for displacement ventilation

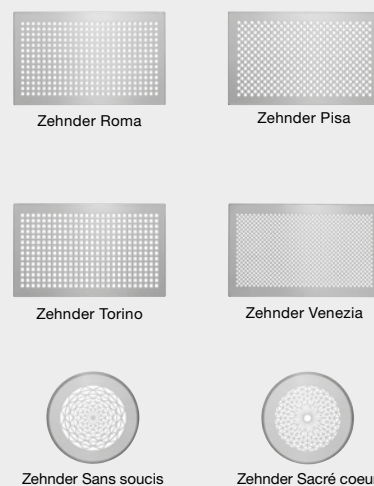

# Warm colours

**zehnder**

## Colour category 1: CORE

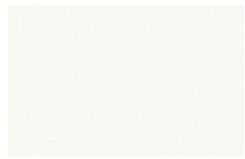

**White Quartz** <sup>1)</sup>  
0521

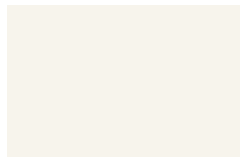

**Pure White** <sup>2)</sup>  
RAL 9010 / 9010

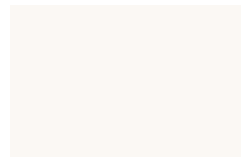

**Edelweiss**  
0067

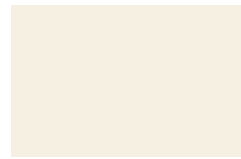

**Cream**  
RAL 9001 / 9001



**Telegrey 4**  
RAL 7047 / 7247

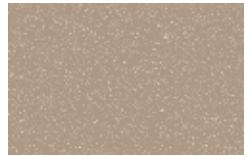

**Beige Quartz**  
0523



**Golden Sand**  
0258



**Yellow Grey**  
RAL 7034 / 7234

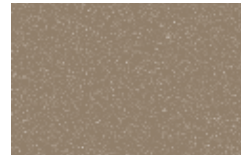

**Pearl Beige**  
RAL 1035 / 1235



**Beach Gold**  
0272



**Concrete Grey**  
0265



**Beige Grey**  
0267

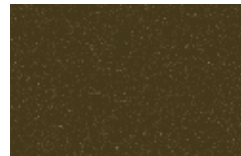

**Bronze**  
0276



**Brown Quartz**  
0529

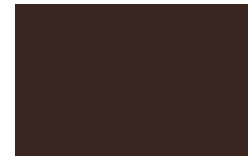

**Dark Brown**  
0270

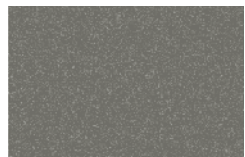

**Grey Aluminium**  
9007

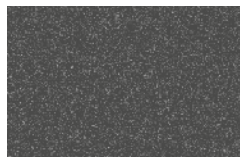

**Anthracite**  
0346

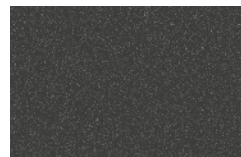

**Umbra Grey**  
RAL 7022 / 7222



**Volcanic**  
0336



Surcharge for colour category 1: 20 %

## Colour category 2: TREND

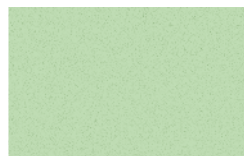

**Pastel Green**  
RAL 6019 / 6219



**Reseda Green**  
RAL 6011 / 6211



**Cement Grey**  
RAL 7033 / 7233



**Olive Green**  
RAL 6003 / 6203



**Terracotta Faded**  
0299



**Terracotta**  
0292



**Ruby Red**  
RAL 3003 / 3003



Surcharge for colour category 2: 30 %

<sup>1)</sup> Unlike to the colour standard (here RAL tone) the Zehnder no. also includes the features matt respectively glossy. Therefore the RAL standard and Zehnder no. differ in many colours. Please note that the prices always relate to the given finishes matt or glossy, deviating finishes will be calculated like colours outside of the colour cart. These colours are finished with a gloss finish; all other colours are matt-finished.

<sup>1)</sup> Not for Zehnder Nova, Nova Neo and Excelsior

<sup>2)</sup> Standard colour for Fare Tech & Alura Tech, therefore Traffic White RAL 9016 with surcharge 20 % on category 1

<sup>3)</sup> Only for Zehnder Charleston and Zehnder Metropolitan

# Cool colours

## Colour category 1: CORE

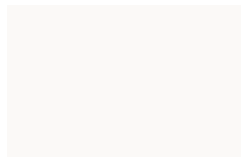

**White Matt**  
0556

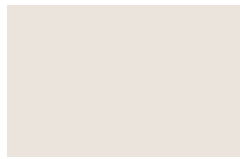

**Light Beige**  
0253



**Light Grey**  
0262



**White Aluminium**  
9006

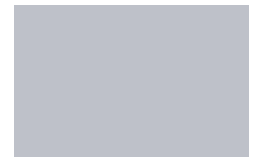

**Light Jeans**  
0264

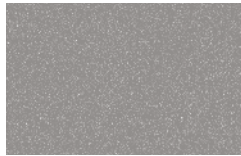

**Titane**  
0335

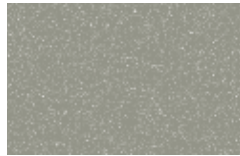

**Inox Look**  
0332

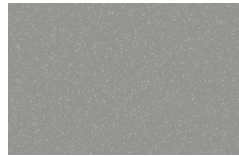

**Telegrey 2**  
RAL 7046 / 7246



**Blue Grey**  
RAL 7031 / 7231



**Anthracite Grey**  
RAL 7016 / 7016



**Black Quartz**  
0550

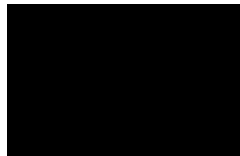

**Black Matt**  
0557

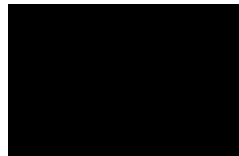

**Traffic Black**  
RAL 9017 / 9217

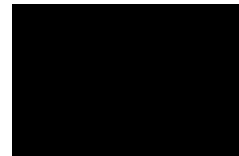

**Jet Black**  
RAL 9005 / 9005

Surcharge for colour category 1: 20 %

## Colour category 2: TREND



**Pastel Blue**  
RAL 5024 / 5224



**Pigeon Blue**  
RAL 5014 / 5214



**Gentian Blue**  
RAL 5010 / 5210



**Sapphire Blue**  
RAL 5003 / 5203



**Blue Night**  
0289

Surcharge for colour category 2: 30 %

## STANDARD



**Traffic White**  
RAL 9016 / 9016

## FINISHES



**Technoline (Clear)**<sup>3)</sup>  
0325



**Chrome (Surface)**  
0008



**Stainless steel brushed**  
9517

Some colours/surfaces are only available for selected products. Please also see the notes on the respective product pages. For Special surfaces of the Studio Collection, please see the respective product chapters. Special colours on request. Due to different manufacturing techniques of the original colours, deviations can occur in colour and polish. RAL and NCS are designations from the manufacturer. The respective colour code (ED) is set at the 9th and 10th places in the article no.

Other special finishes in the RAL, RAL-D, NCS-S, Sanitary, DB colour systems are available as required, surcharges on request.

